

W. A. BLYCKERT, R. D. CARTER, AND K. R. RIDGWAY, "CRITICALITY HANDBOOK , VOLUME III," ATLANTIC RICHFIELD HANFORD CO. REPORT ARH-600 (1968).

Criticality Handbook

Volume III

W. A. Blyckert
R. D. Carter
K. R. Ridgway

Atlantic Richfield Hanford Company
Richland, Washington 99352

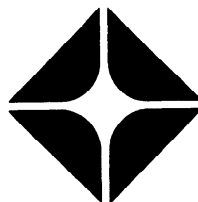

Atlantic Richfield Hanford Company
Richland, Washington 99352



CRITICALITY HANDBOOK

Volume III

September 1, 1971

W. A. Blyckert
R. D. Carter
K. R. Ridgway

Advance Process Development Section
Research and Development Department
Chemical Processing Division

PREPARED FOR THE U.S. ATOMIC ENERGY
COMMISSION UNDER CONTRACT AT(45-1) 2130

PRELIMINARY REPORT

THIS REPORT CONTAINS INFORMATION OF A PRELIMINARY NATURE. IT IS SUBJECT TO REVISION OR CORRECTION AND THEREFORE DOES NOT REPRESENT A FINAL REPORT. IT WAS PREPARED PRIMARILY FOR INTERNAL USE WITHIN THE ATLANTIC RICHFIELD HANFORD COMPANY. ANY EXPRESSED VIEWS AND OPINIONS ARE THOSE OF THE AUTHOR AND NOT NECESSARILY OF THE COMPANY.

NOTICE

THIS REPORT WAS PREPARED AS AN ACCOUNT OF WORK SPONSORED BY THE UNITED STATES GOVERNMENT. NEITHER THE UNITED STATES NOR THE UNITED STATES ATOMIC ENERGY COMMISSION, NOR ANY OF THEIR EMPLOYEES, NOR ANY OF THEIR CONTRACTORS, SUBCONTRACTORS, OR THEIR EMPLOYEES, MAKES ANY WARRANTY, EXPRESS OR IMPLIED, OR ASSUMES ANY LEGAL LIABILITY OR RESPONSIBILITY FOR THE ACCURACY, COMPLETENESS OR USEFULNESS OF ANY INFORMATION, APPARATUS, PRODUCT OR PROCESS DISCLOSED, OR REPRESENTS THAT ITS USE WOULD NOT INFRINGE PRIVATELY OWNED RIGHTS.

GENERAL CONTENTS

- III. HOMOGENEOUS DATA, PARTS C AND D
- IV. HETEROGENEOUS DATA
- V. INTERACTING SYSTEMS
- VI. POISONED SYSTEMS

PREFACE

The expansion of ARH-600 to three volumes has been required by the addition of new data. The size of Section III and the desire to keep each volume small for ease in handling has required a rather awkward division of this section between Volumes II and III. A significant amount of data is available for inclusion into Sections IV and VI and hopefully will be added in the future if time permits.

III. HOMOGENEOUS SYSTEMS

- A. PLUTONIUM SYSTEMS (SEE VOLUME II)
- B. URANIUM-235 SYSTEMS (SEE VOLUME II)
- C. URANIUM-233 SYSTEMS
- D. MIXED AND MISCELLANEOUS SYSTEMS

III. HOMOGENEOUS DATA

C. URANIUM-233 SYSTEMS

1. Correlation Between Calculation and Experiment
2. H/U versus Uranium g/l Relationship
3. Critical Sphere Dimensions

All graphs within this and following divisions have the percentage by weight of the major fissile atom (U-233) as the fourth identification number, e.g., III.C.3(97)-2 would signify the second graph showing data for uranium containing 97 weight percent U-233.

4. Critical Cylinder Dimensions
5. Critical Slab Dimensions
6. Critical Mass - Sphere
7. Critical Mass per Unit Height - Cylinder
8. Critical Mass per Unit Area - Slab
9. Critical Volume
10. Material Bucklings and Infinite Multiplication Factor

BASIC URANIUM-233 CRITICAL PARAMETERS

These basic values are taken from references which would normally be used as bases for standards. ARH-600 values compare favorably.

<u>METAL</u> (1) (2)	<u>Full Reflection*</u>	<u>Bare**</u>
Minimum critical spherical mass, Kgs ^{233}U 18.66 g/cm ³	7.6	17.0
Infinite cylinder diameter, inches, ^{233}U 18.66 g/cm ³	2.01	3.2
Infinite slab thickness, inches, ^{233}U 18.66 g/cm ³	0.247	1.8
Minimum spherical volume, liters, ^{233}U 18.66 g/cm ³	.407	.84
<u>HOMOGENEOUS SOLUTIONS</u> (2) (3)		
Minimum critical mass, g ^{233}U	570	1200
Infinite cylinder diameter, inches	4.68	7.5
Infinite slab thickness, inches	1.26	4.0
Minimum spherical volume, liters	3.7	8.7
Minimum areal concentration g/ft ²	341	~440
Minimum critical aqueous concentration, g/l ^{233}U	11.25 ± 0.10 (2) 11.2 (3)	

* Reflector is water unless otherwise specified.

** "Bare" solutions have 1/16-inch stainless steel reflector

-
- (1) W. H. Roach and D. R. Smith. "Estimates of Maximum Subcritical Dimensions of Single Fissile Metal Units", ORNL-CDC-3, October, 1967, (reflected metal systems).
- (2) H. C. Paxton, et al. "Critical Dimensions of Systems Containing ^{235}U , ^{239}Pu and ^{233}U ", TID-7028, June, 1964, (for all bare systems unless otherwise noted; solutions are U(100)-H₂O with correction for H/U relationships for actual solutions).
- (3) J. W. Webster. "Calculated Neutron Multiplication Factors of Uniform Aqueous Solutions of ^{233}U and ^{235}U ", ORNL-CDC-2, October, 1967, (for reflected U(100)O₂F₂ systems).

III.C.1 Correlations Between Calculation and Experiment

The primary means of producing the data in this section, as in previous homogeneous solution sections, has been with the combination of the GAMTEC II and HFN computer codes. GAMTEC II was used to produce 18 energy group cross section sets which were then used in HFN to calculate critical sizes. A number of critical experiments were checked to verify the adequacy of the calculations. These are shown below:

Geom.	Reflector	Solution	$^{233}\text{Ug/l}$	Calc. k_{eff}	Remarks
1. Sphere ^(a)	Water	UO_2F_2	39	1.0257	31.9 cm .dia.
2. Sphere ^(a)	Water	$\text{UO}_2(\text{NO}_3)_2$	62	1.012	26.6 cm .dia.
2a. Same as 2				1.011 ± 0.010	KENO Calc. ^(c)
3. Sphere ^(b)	Bare	$\text{UO}_2(\text{NO}_3)_2$	16.8	1.0070	70.5 cm .dia.
4. Cyl. ^(a)	Bare	UO_2F_2	165	1.007	25.5 cm .dia.
5. Cyl. ^(a)	Water	$\text{UO}_2(\text{NO}_3)_2$	49	1.015	25.5 cm .dia. h = 25.5 cm.
6. Cyl. ^(a)	Paraffin	$\text{UO}_2(\text{NO}_3)_2$	336	1.074	19.1 cm .dia. h = 16.2 cm.
7. Cyl. ^(a)	Paraffin	$\text{UO}_2(\text{NO}_3)_2$	336	1.018	15.1 cm .dia. h = 29.0 cm.
8. Cyl. ^(a)	Paraffin	$\text{UO}_2(\text{NO}_3)_2$	275	0.995 ± 0.013	KENO Calc. ^(c)

The calculations performed generally indicate a slight conservatism in the calculational method. The high bias on 6 is at least partly due to the fact that the upper reflector was a significant distance from the top of the solution instead of immediately adjacent as assumed in the calculation.

A number of experiments have been performed in France; correlations with these experiments have not yet been attempted.

(a) Data from ORNL-2143, "Critical Mass Studies, Part VIII, Aqueous Solutions of ^{233}U ", J. K. Fox, et al. Vessels were aluminum, coated with a corrosion inhibitor.

(b) See VI.2-1

(c) Used 16-group Hansen-Roach cross sections.

III.C.2 H/U Versus U g/l Relationships

The following relationships were used to determine solution composition.

For uranium nitrate solutions the relationship between H/U and the uranium concentration was derived from the equation:

$$\rho_{\text{sol}} = 1.0012 + 0.3177 M_{\text{u}} + 0.03096 M_{\text{HNO}_3}$$

For uranium-water solutions the relationship was:

$$H/U = \frac{25860}{(.9790 + .02101f_{233}) \text{ U g/l}} - \frac{1.368}{(.9790 + .02101f_{233})}$$

where f_{233} is the weight fraction of ^{233}U in uranium.

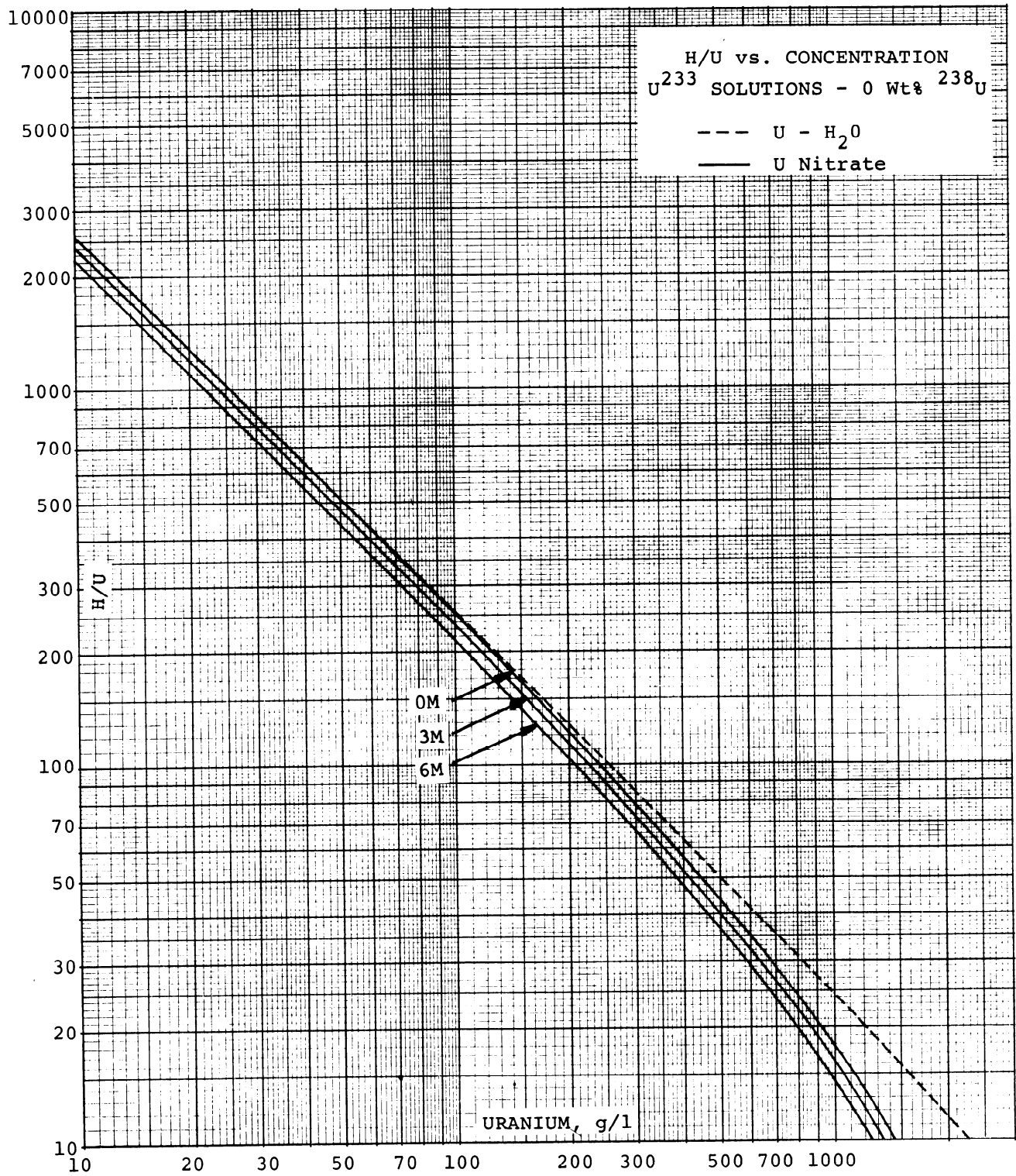

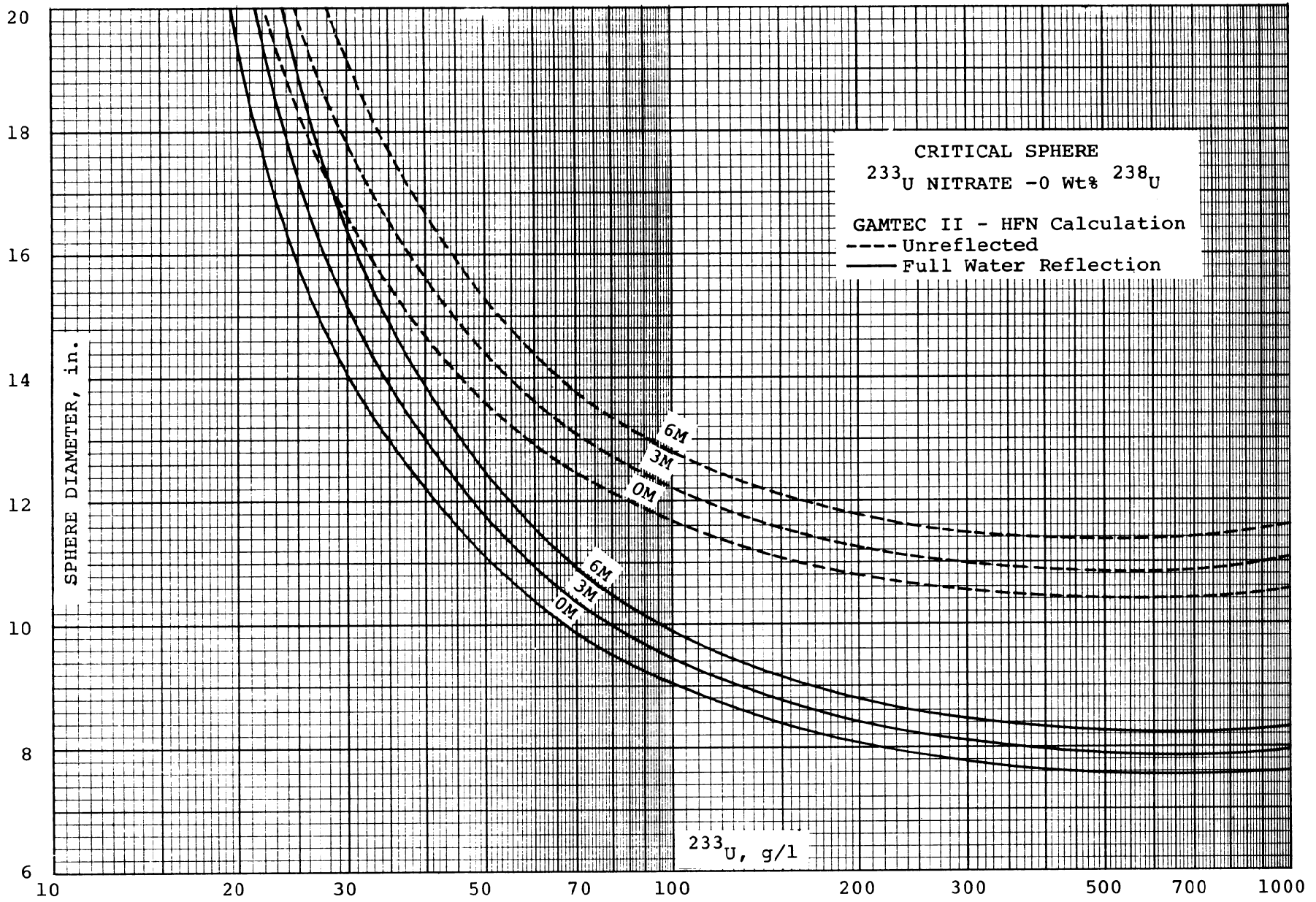

CRITICAL SPHERE
NOMINAL (ONE INCH) WATER REFLECTION
 ^{233}U NITRATE - 0 Wt% ^{238}U
GAMTEC II - HFN Calculation

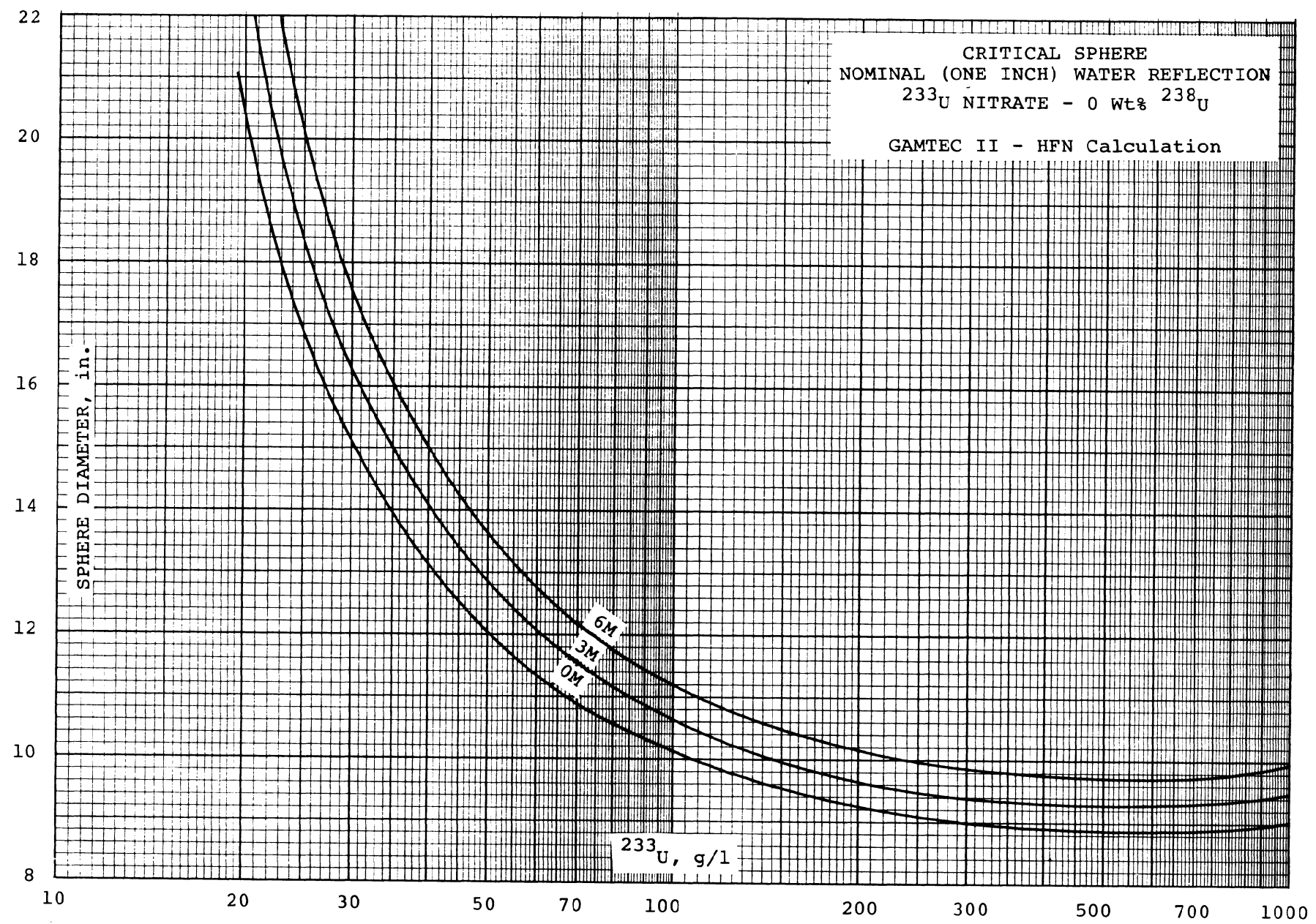

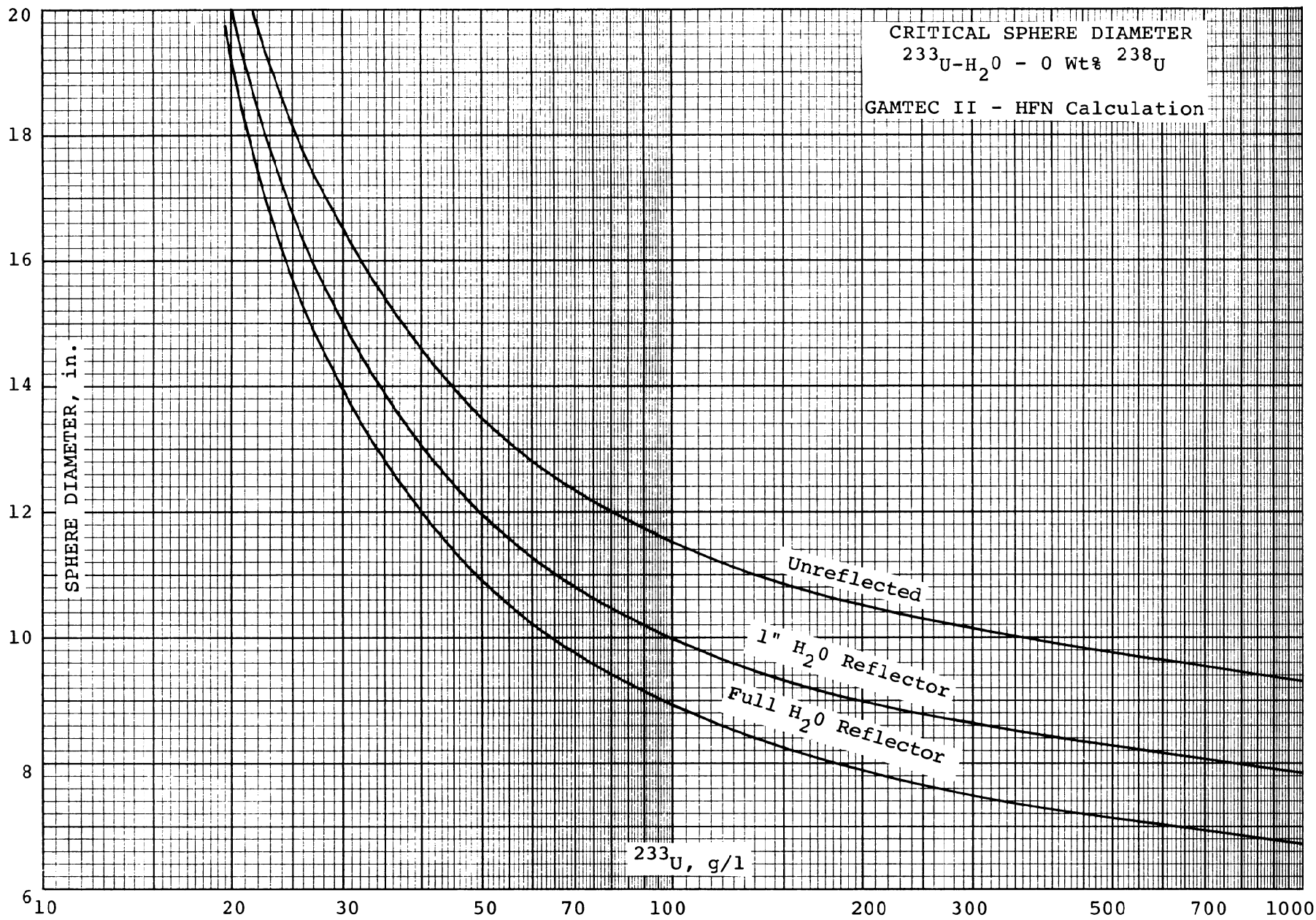

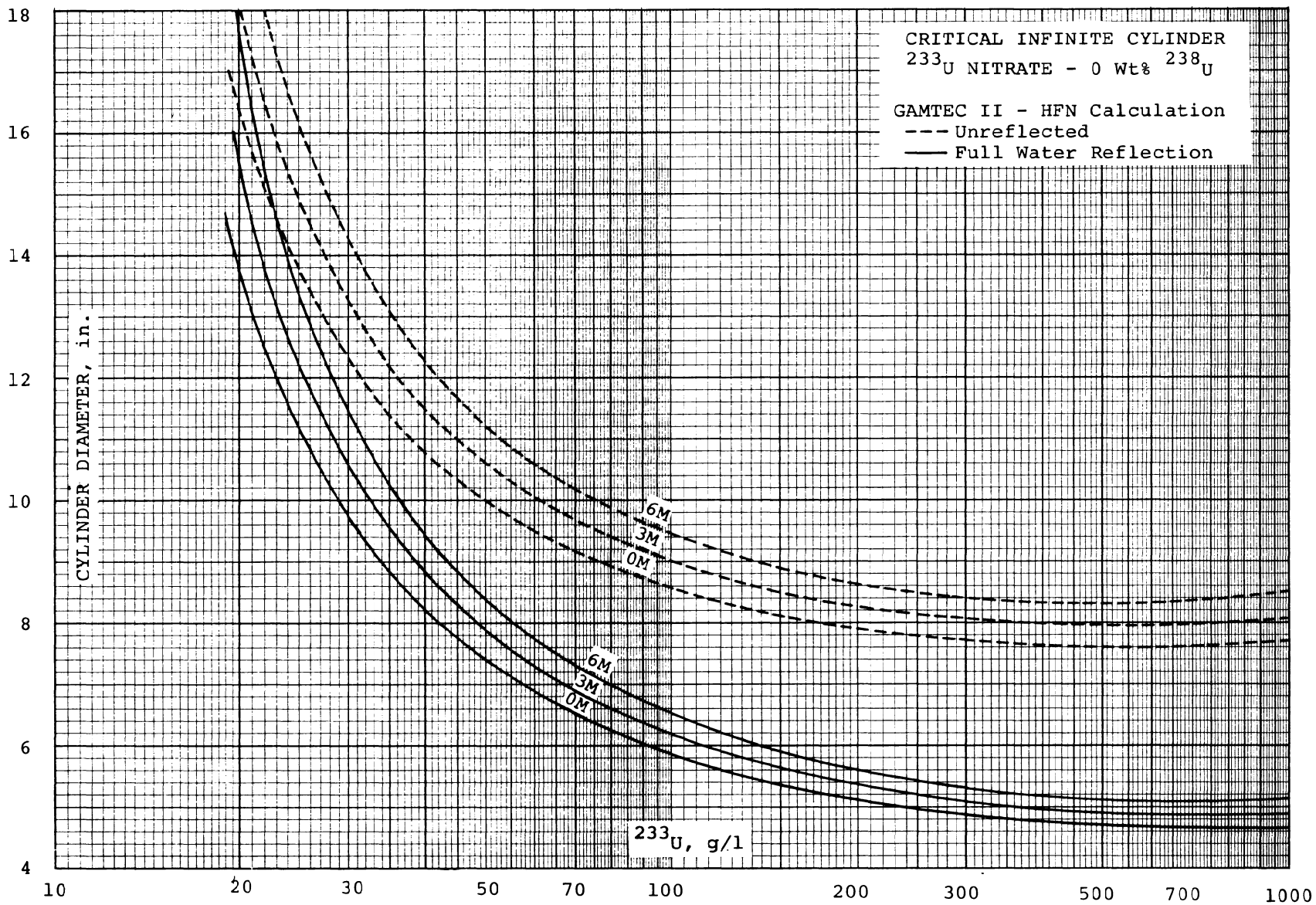

CRITICAL INFINITE CYLINDER
NOMINAL (ONE INCH) WATER REFLECTION
 ^{233}U NITRATE - 0 Wt% ^{238}U
GAMTEC II - HFN Calculation

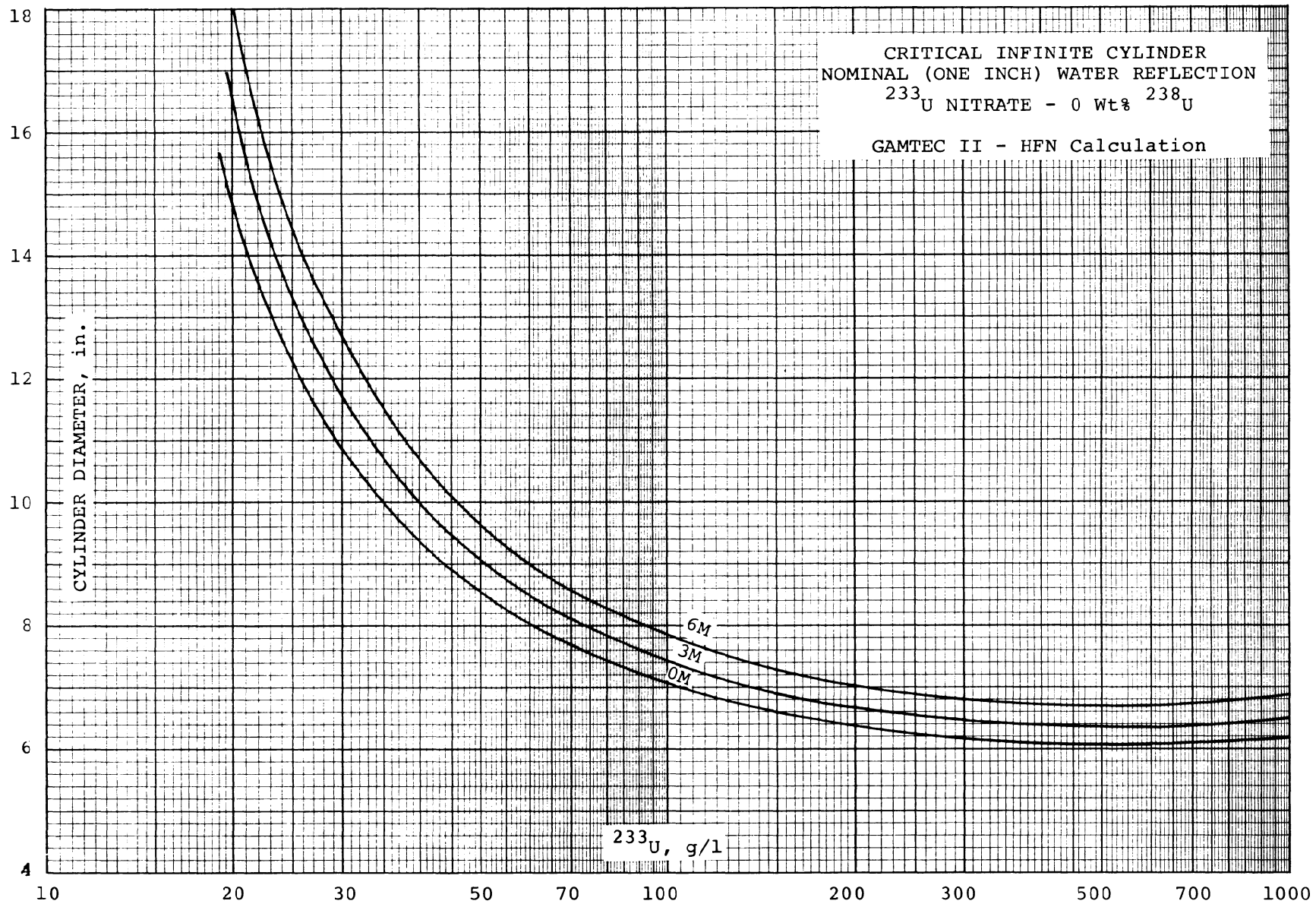

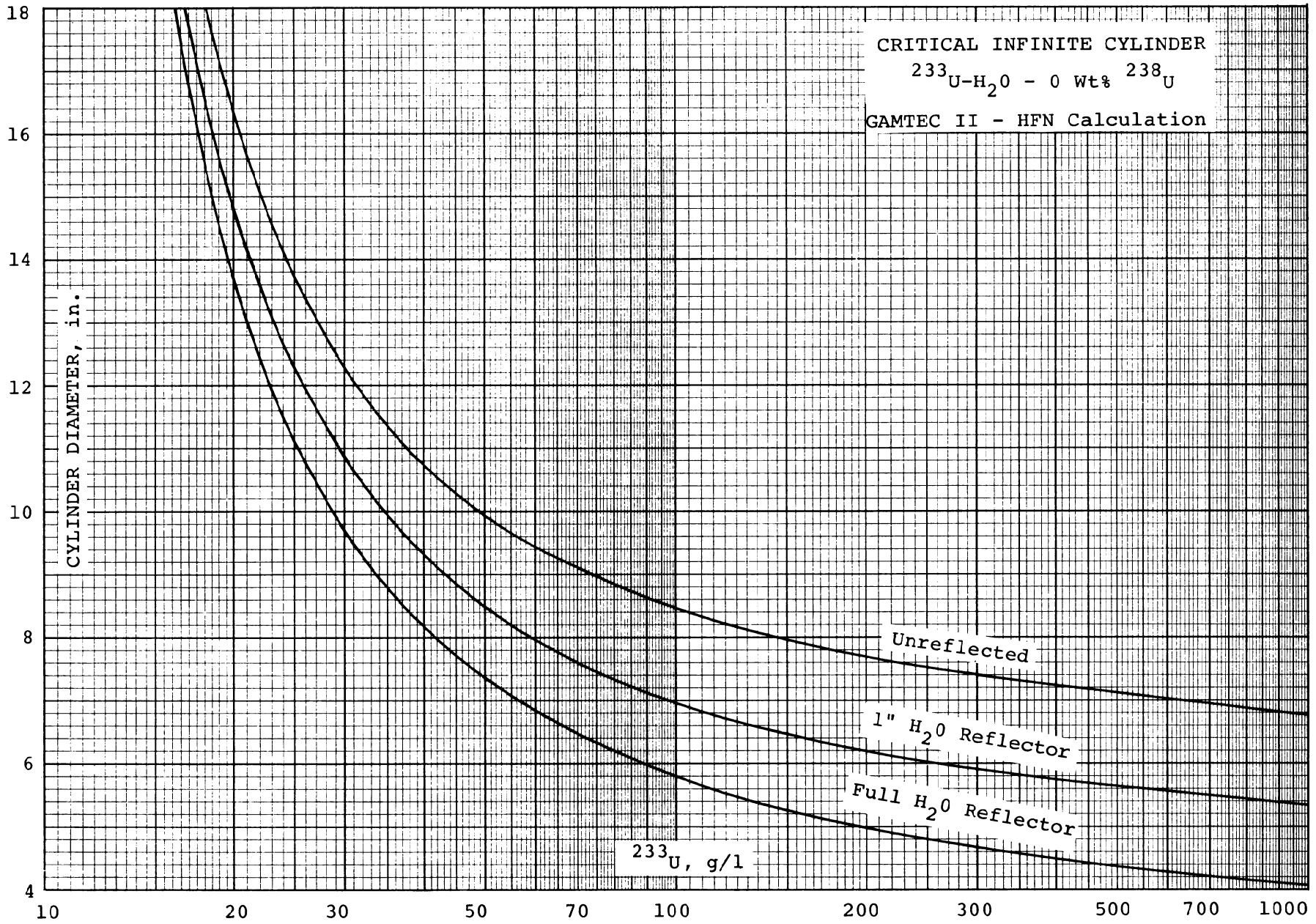

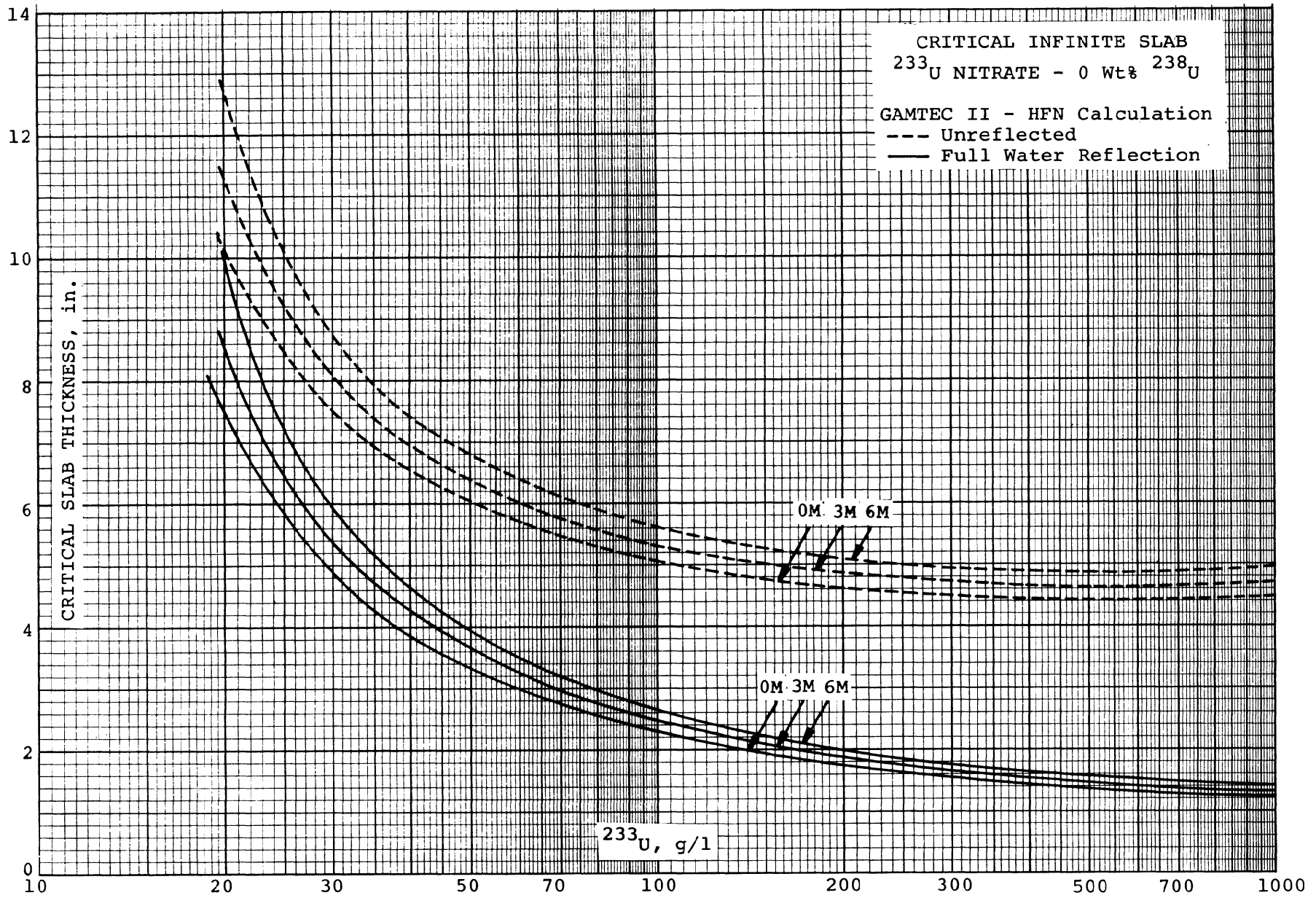

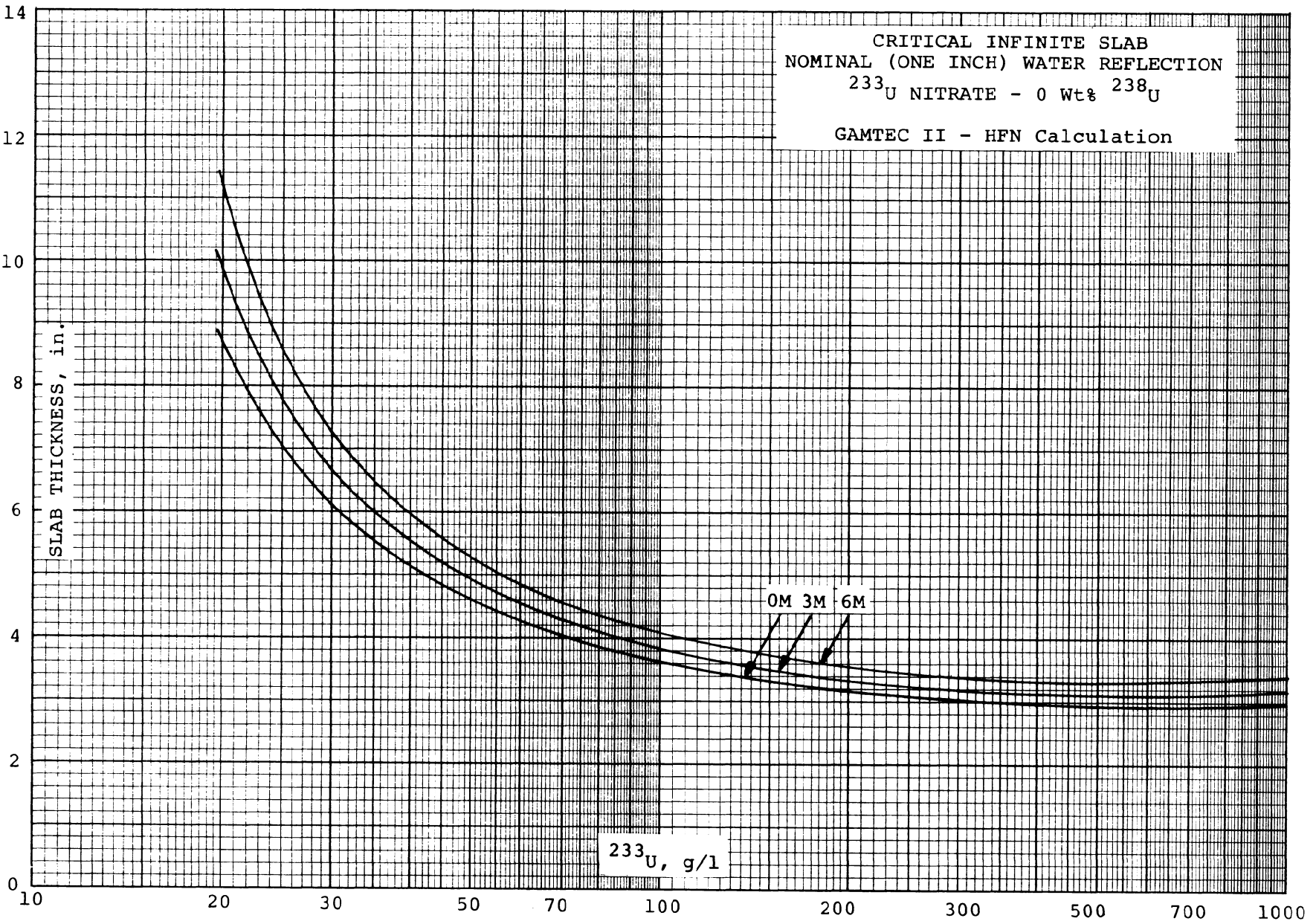

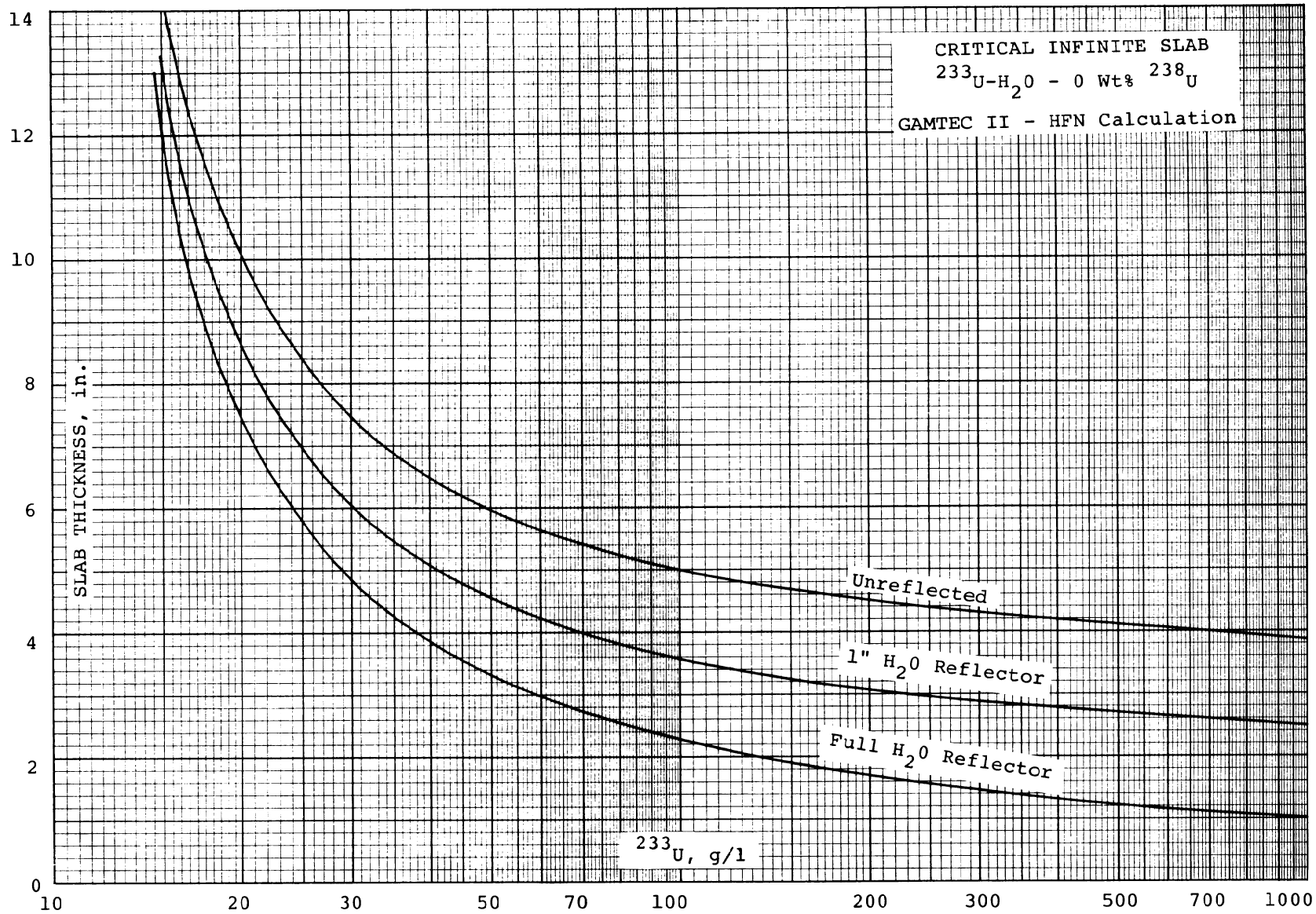

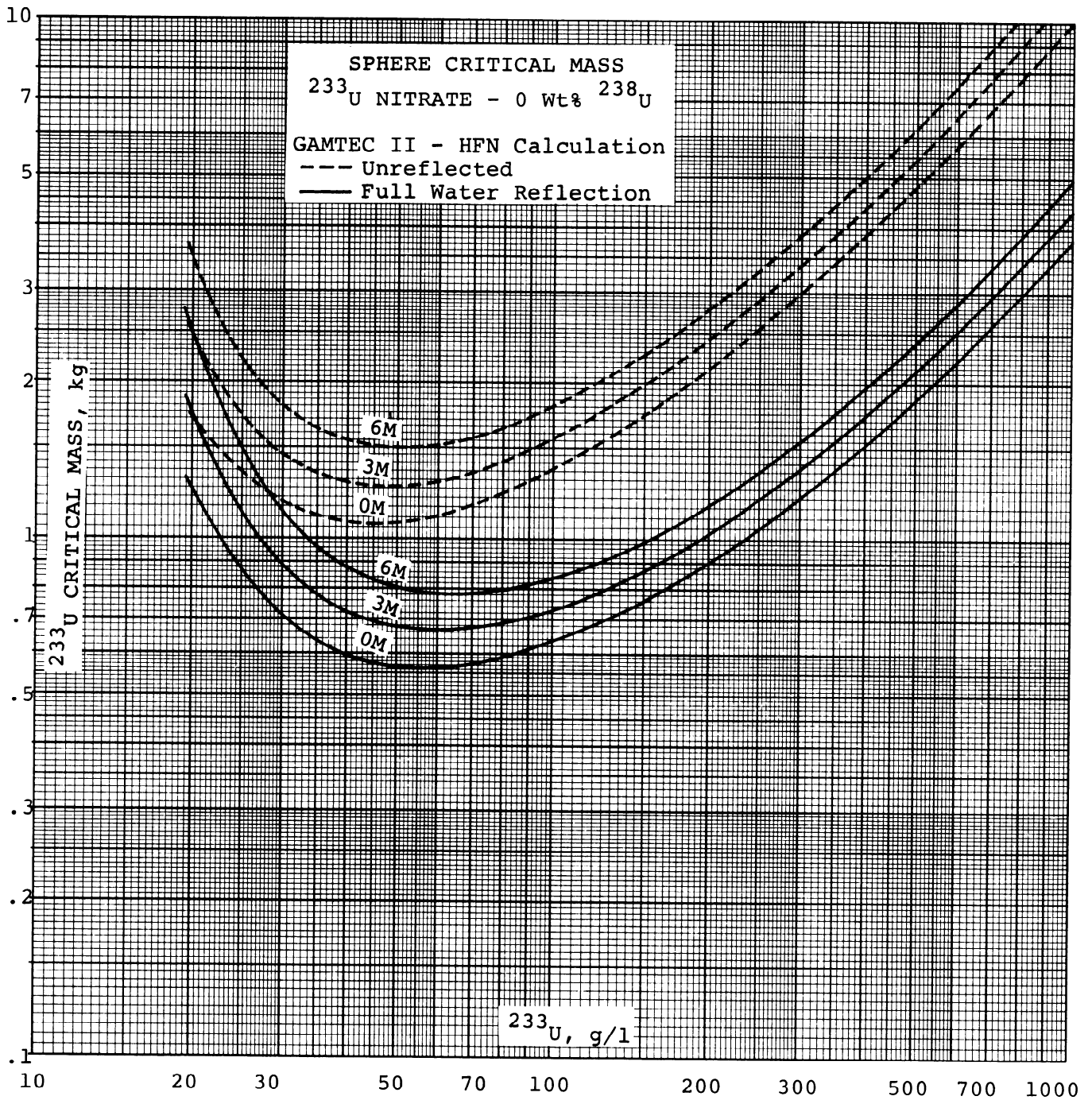

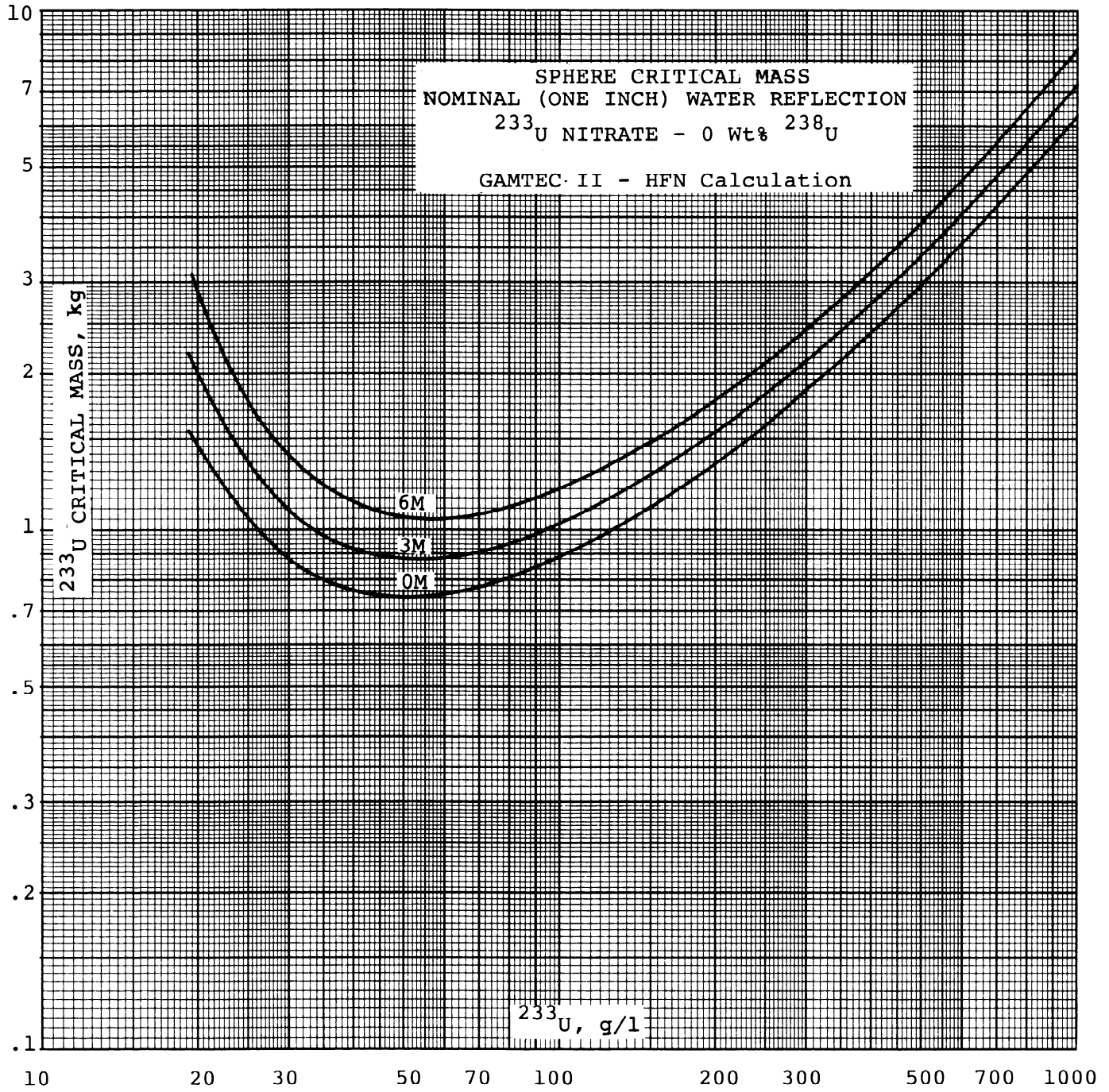

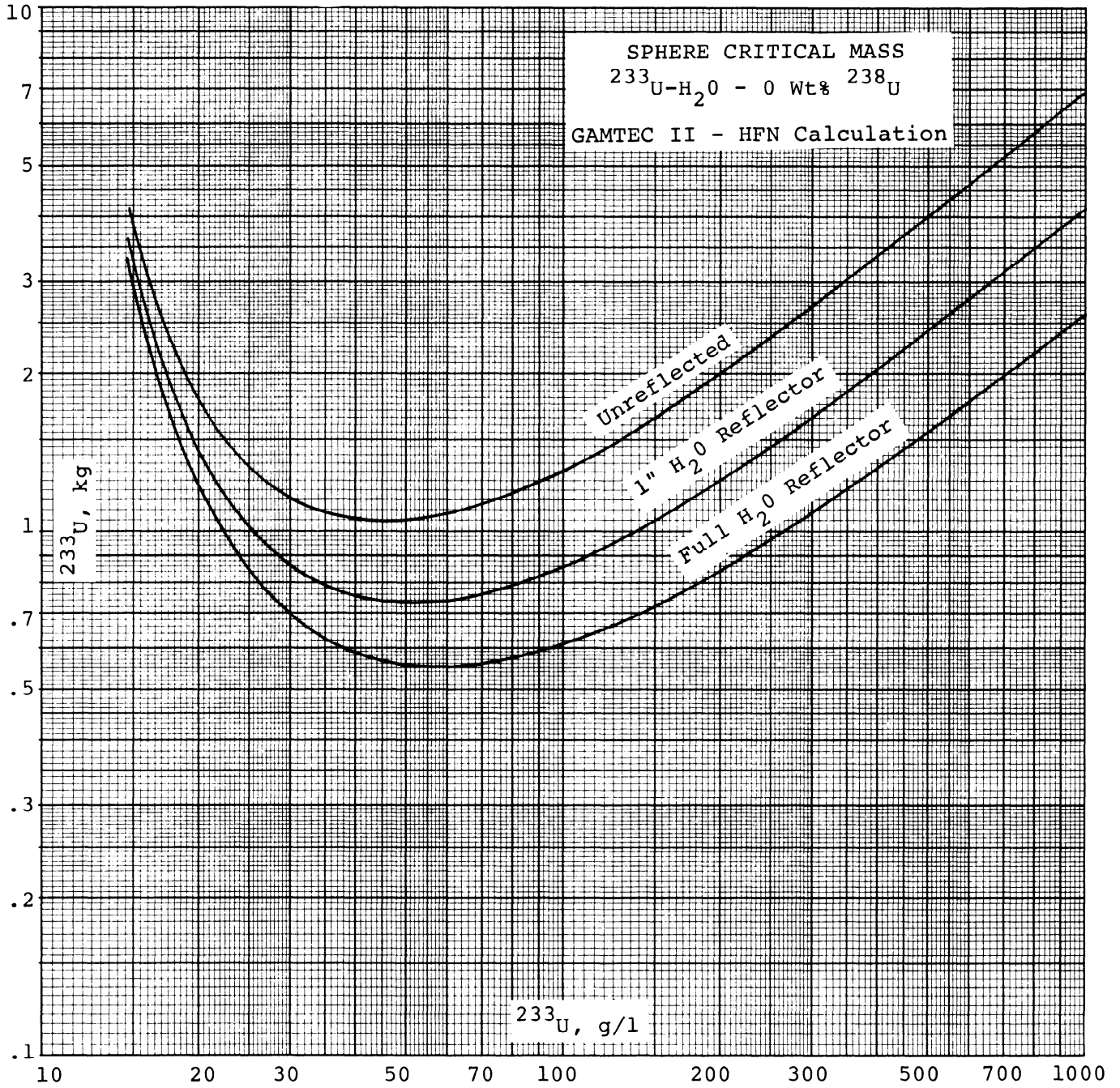

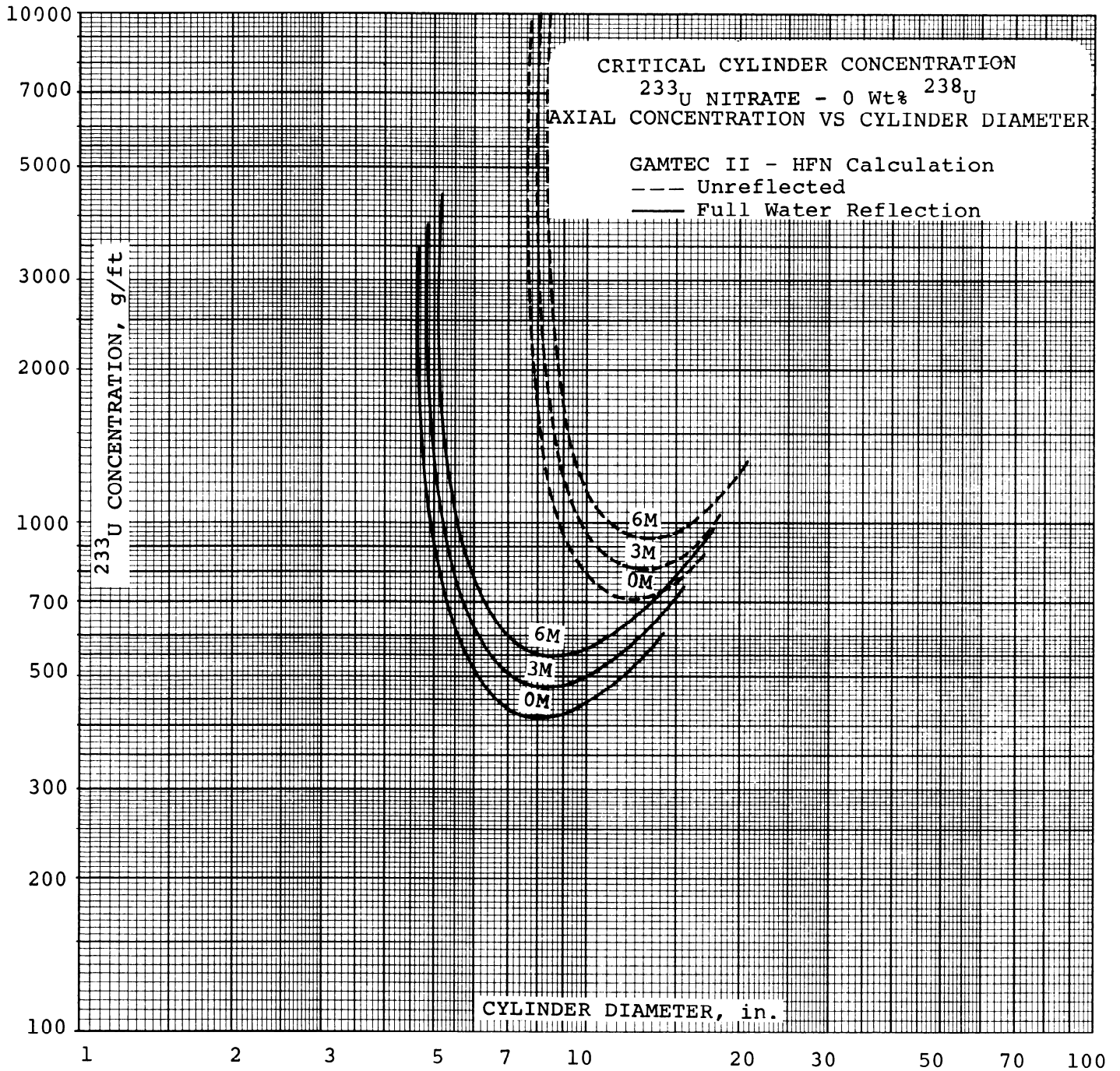

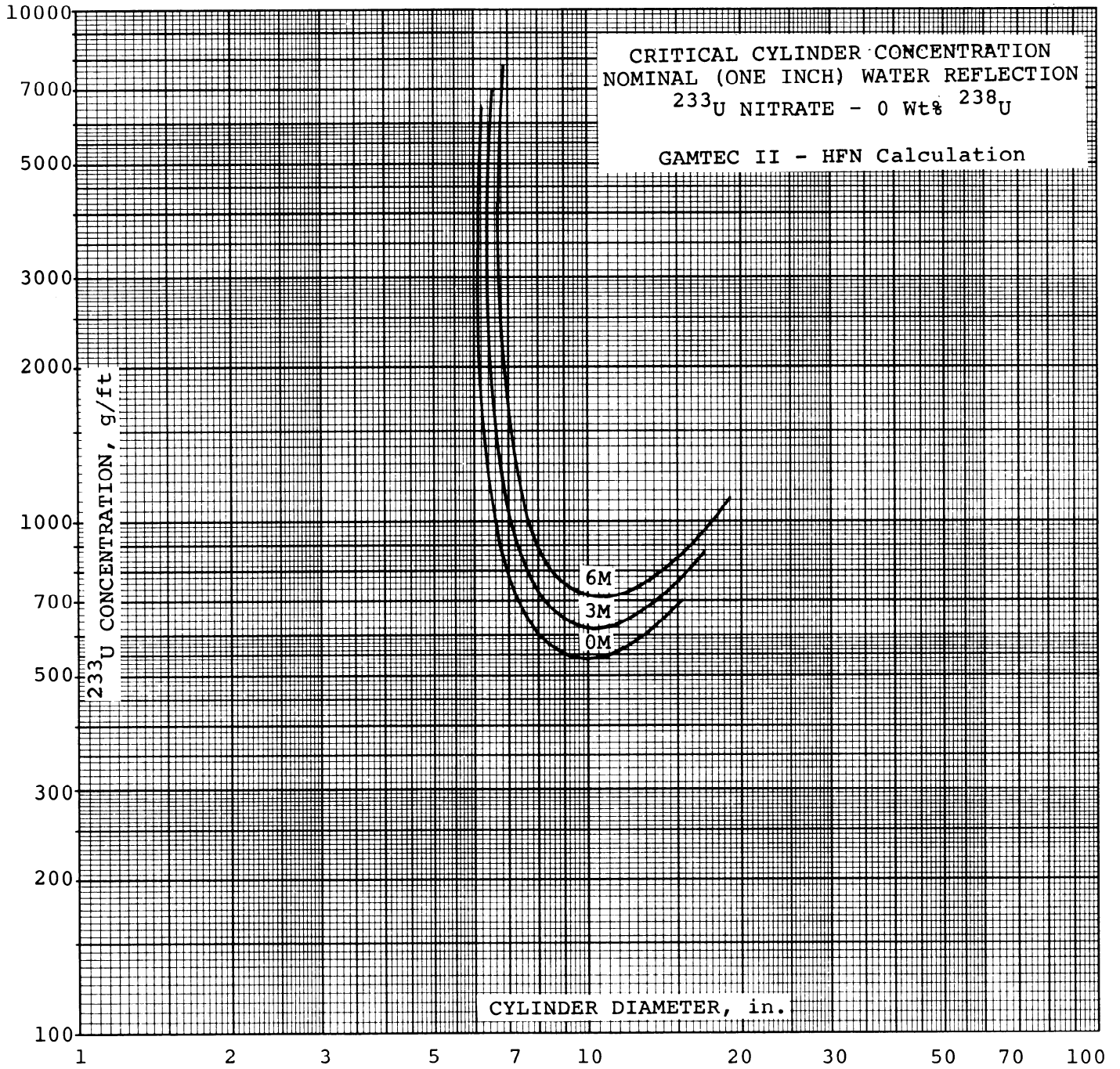

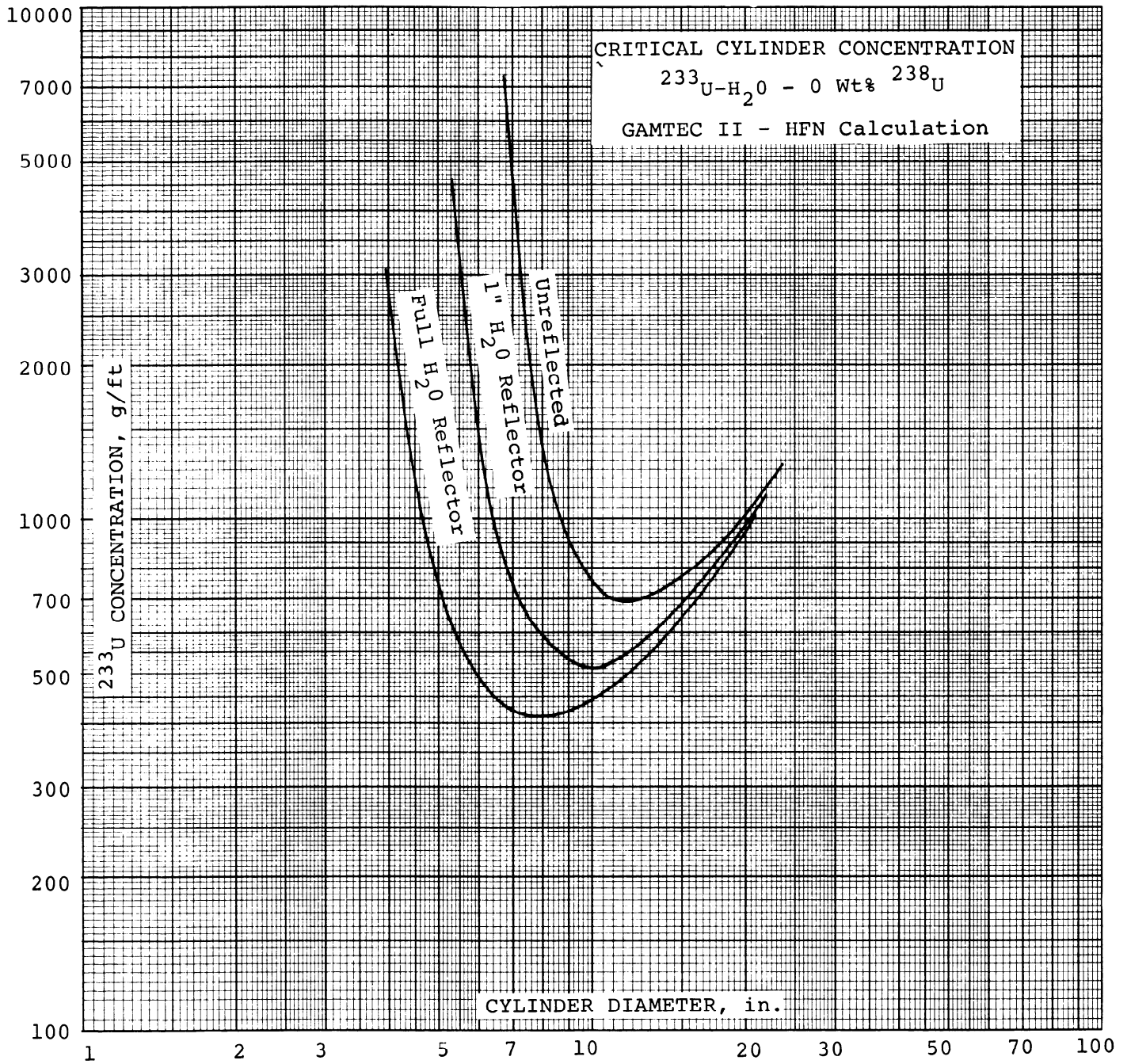

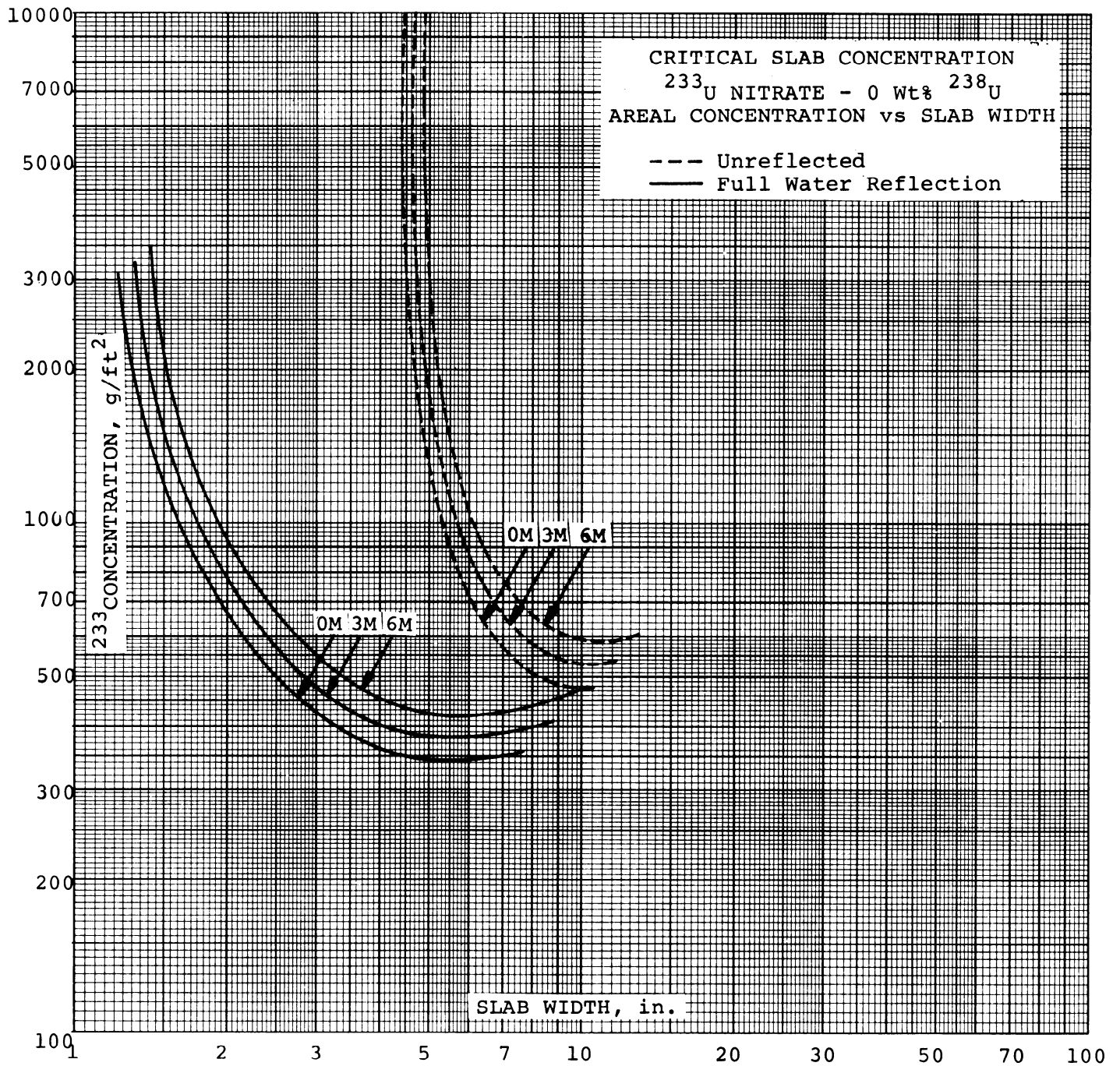

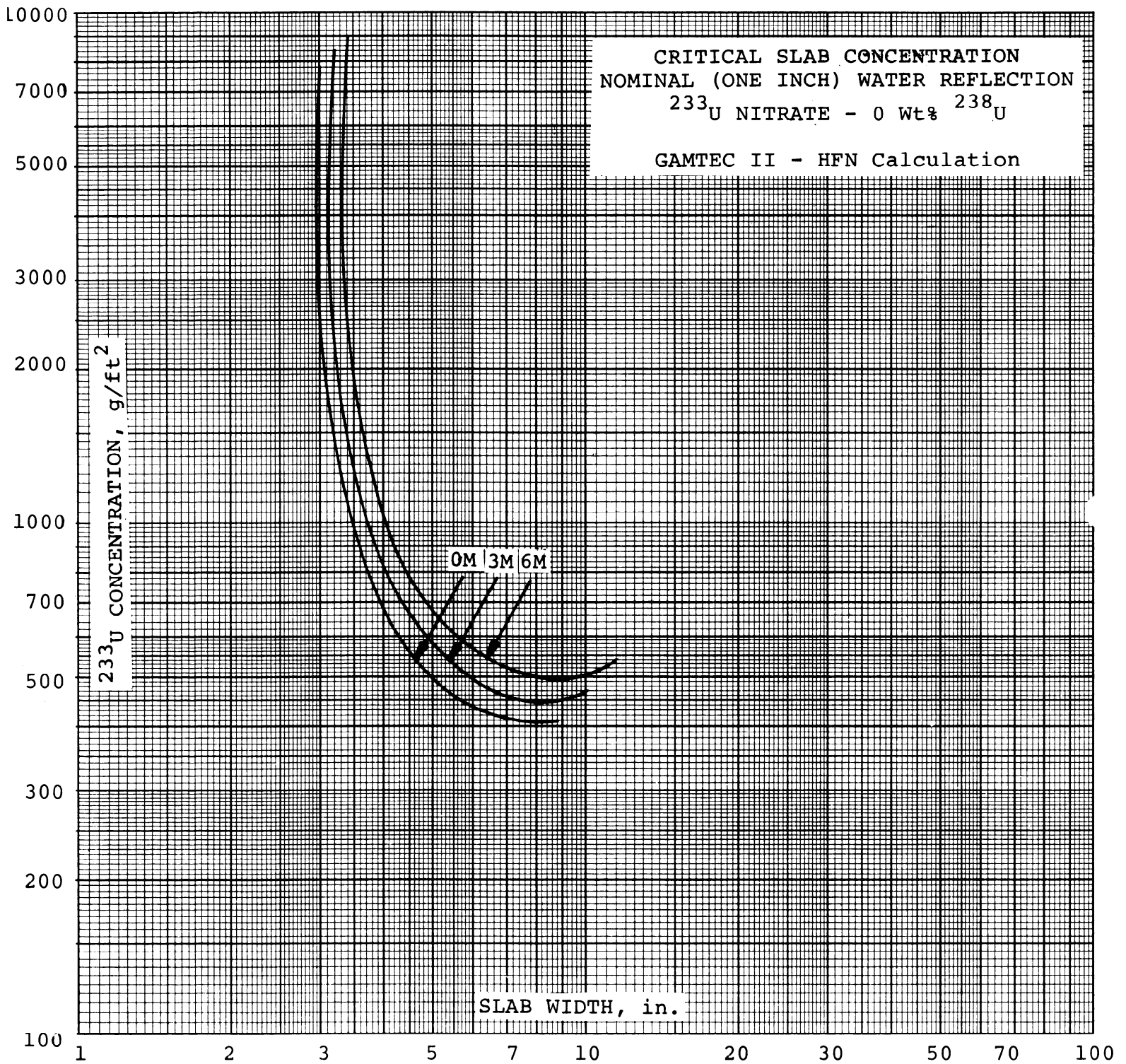

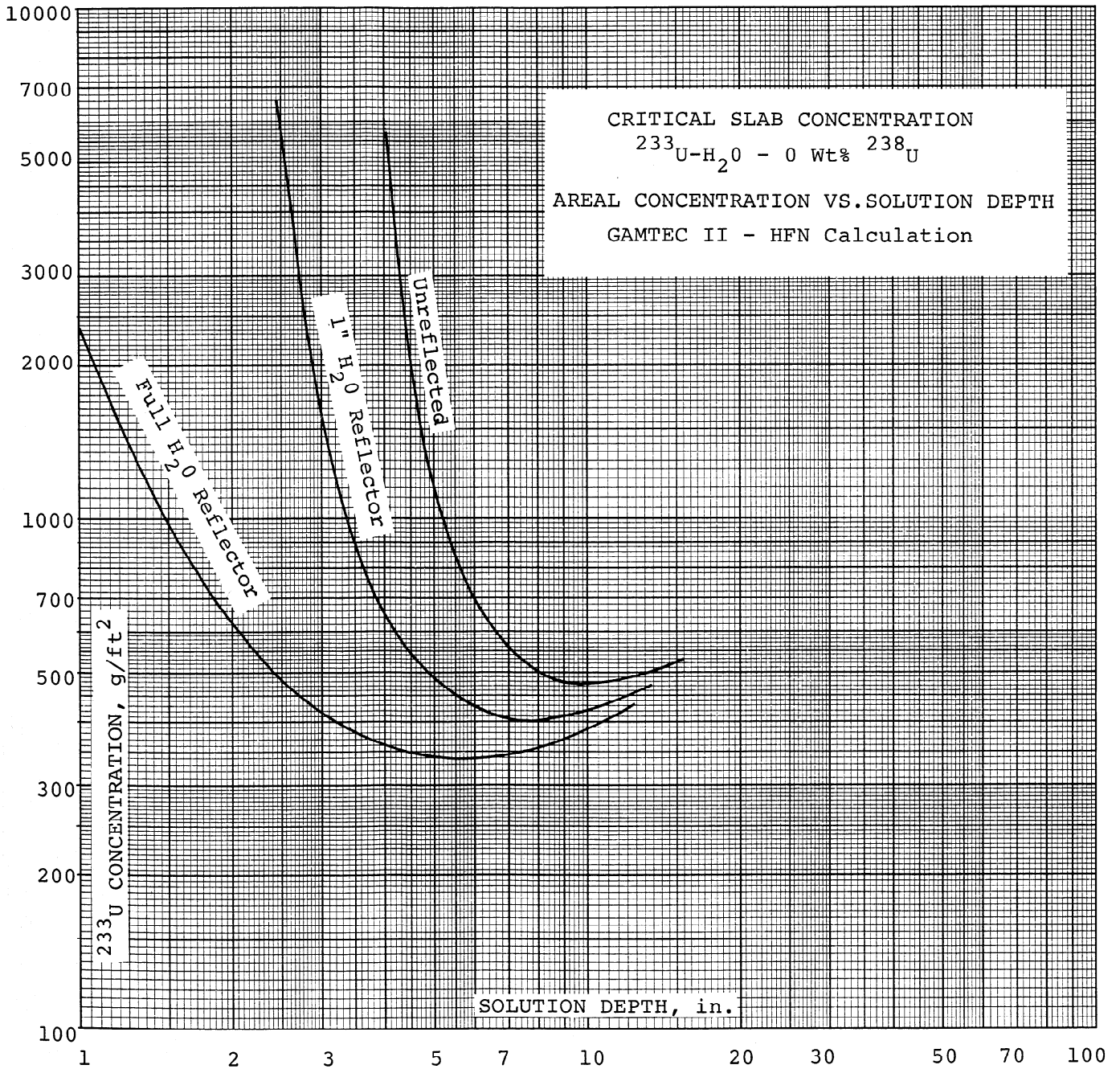

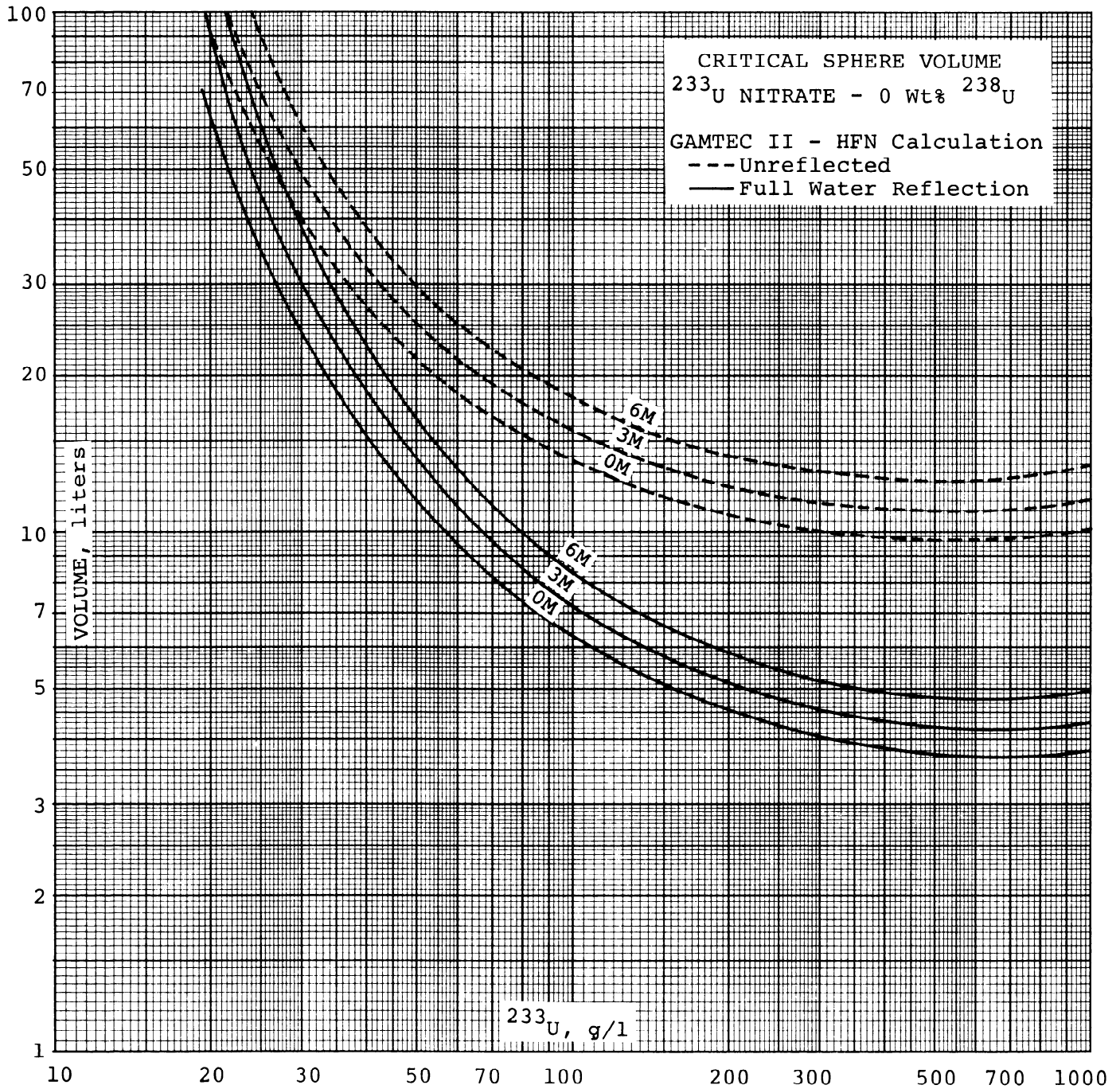

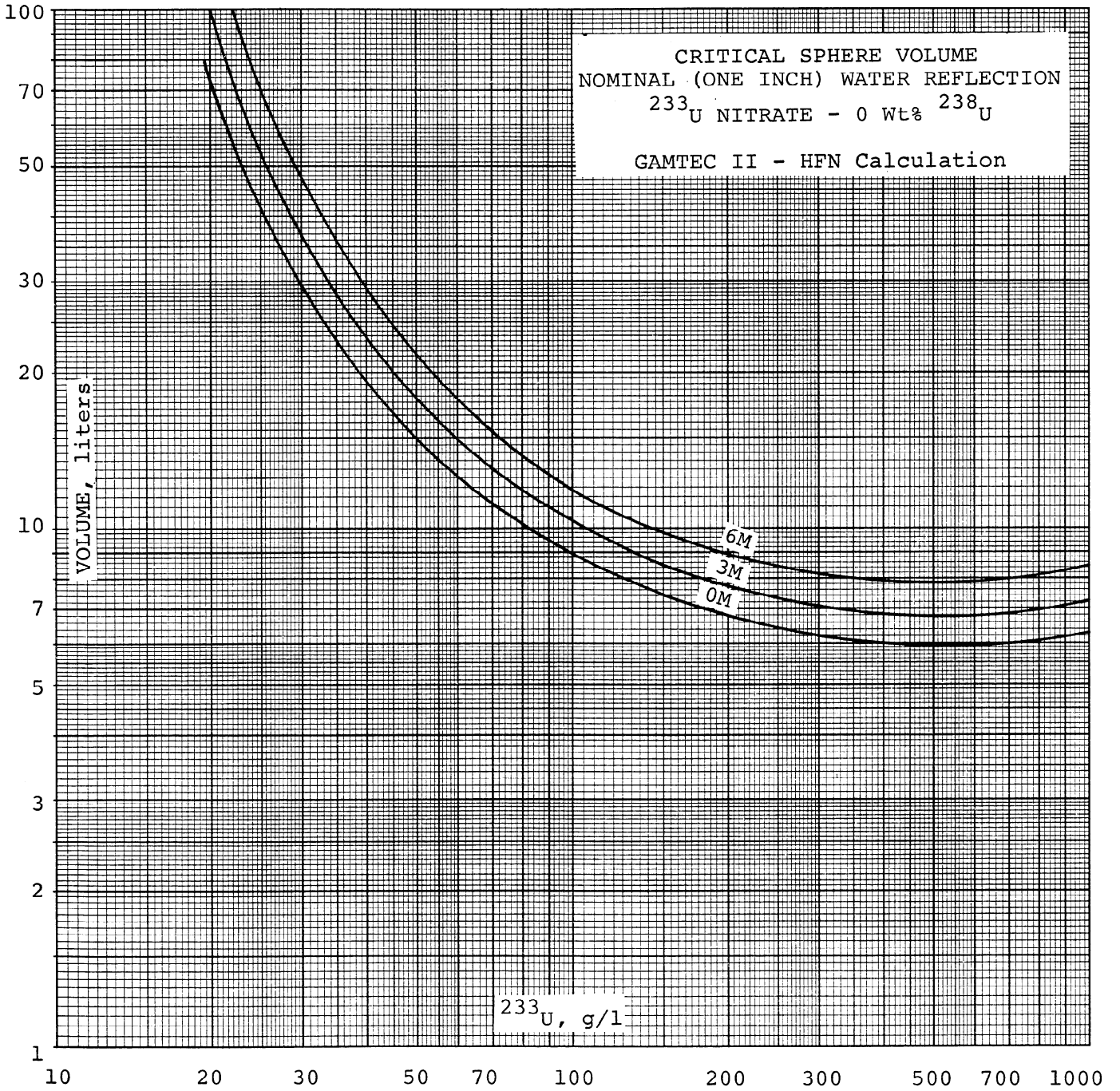

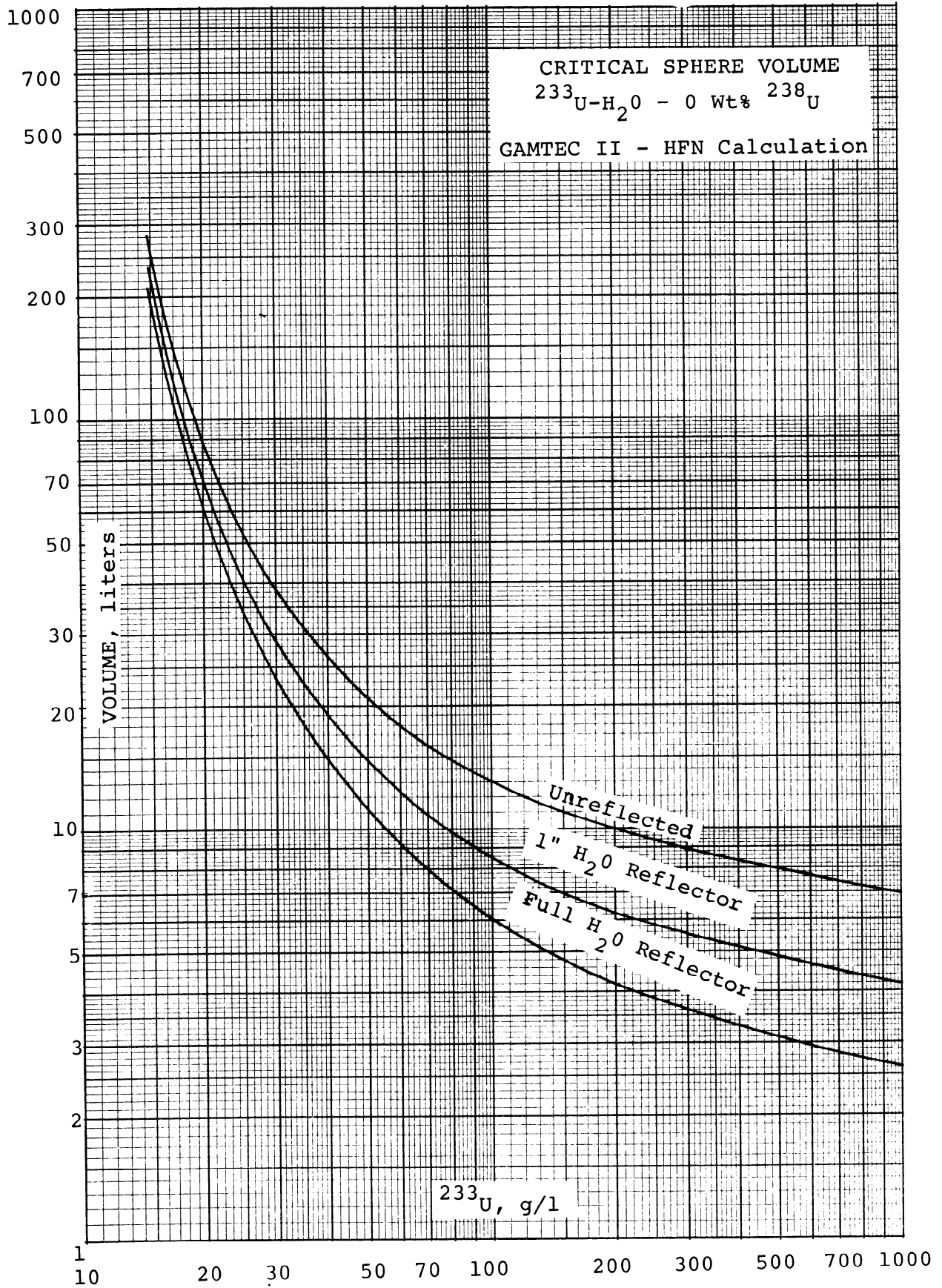

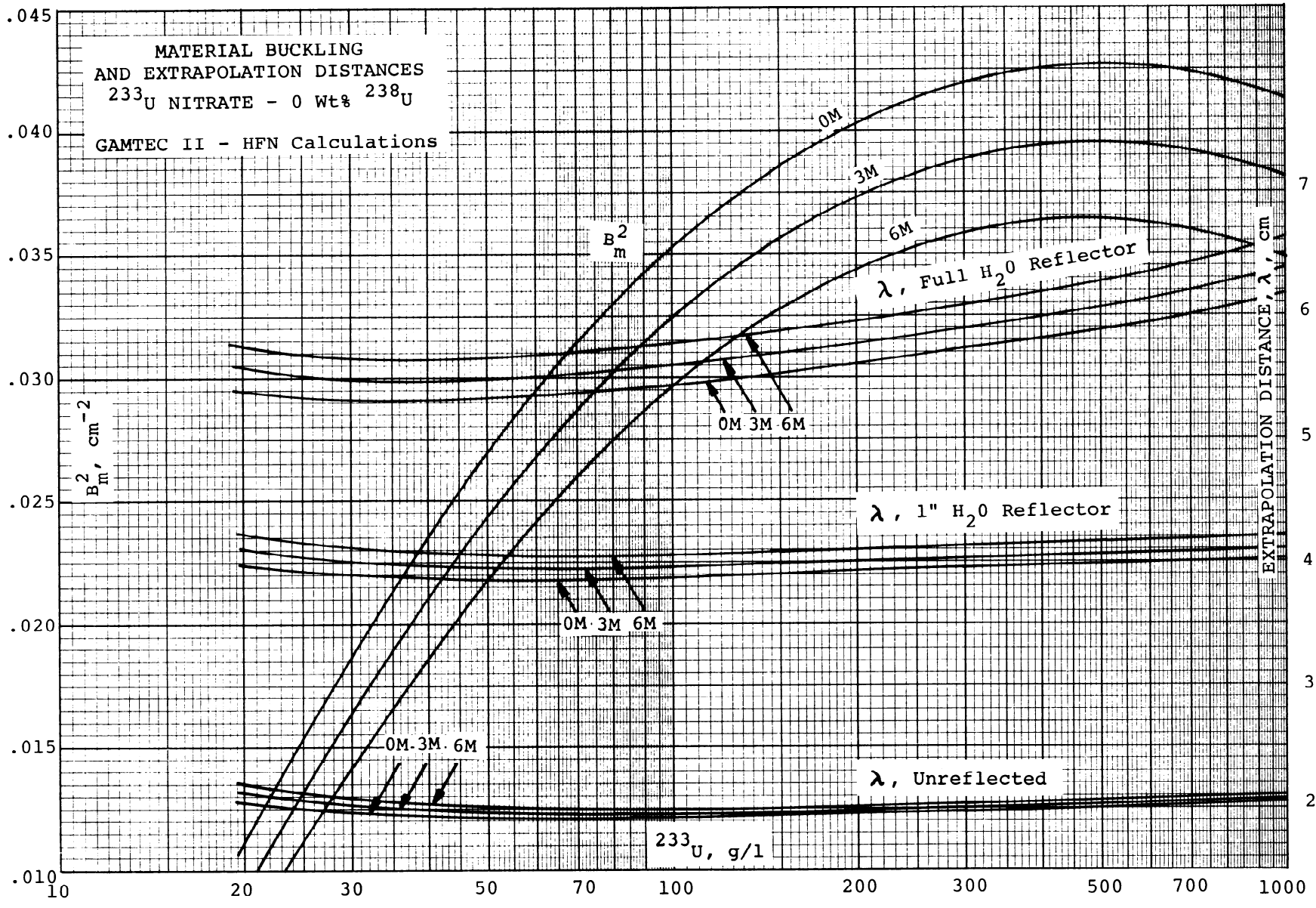

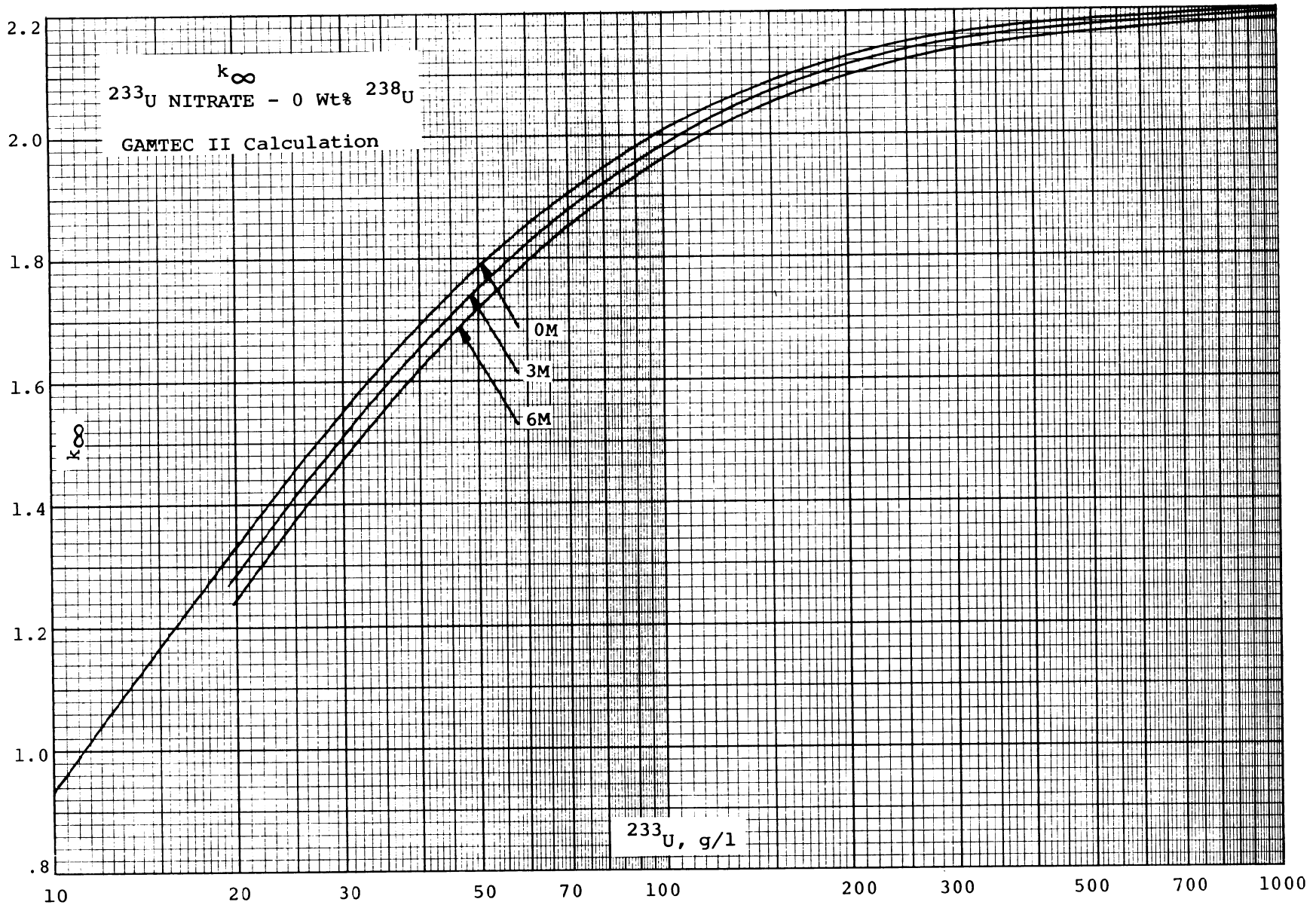

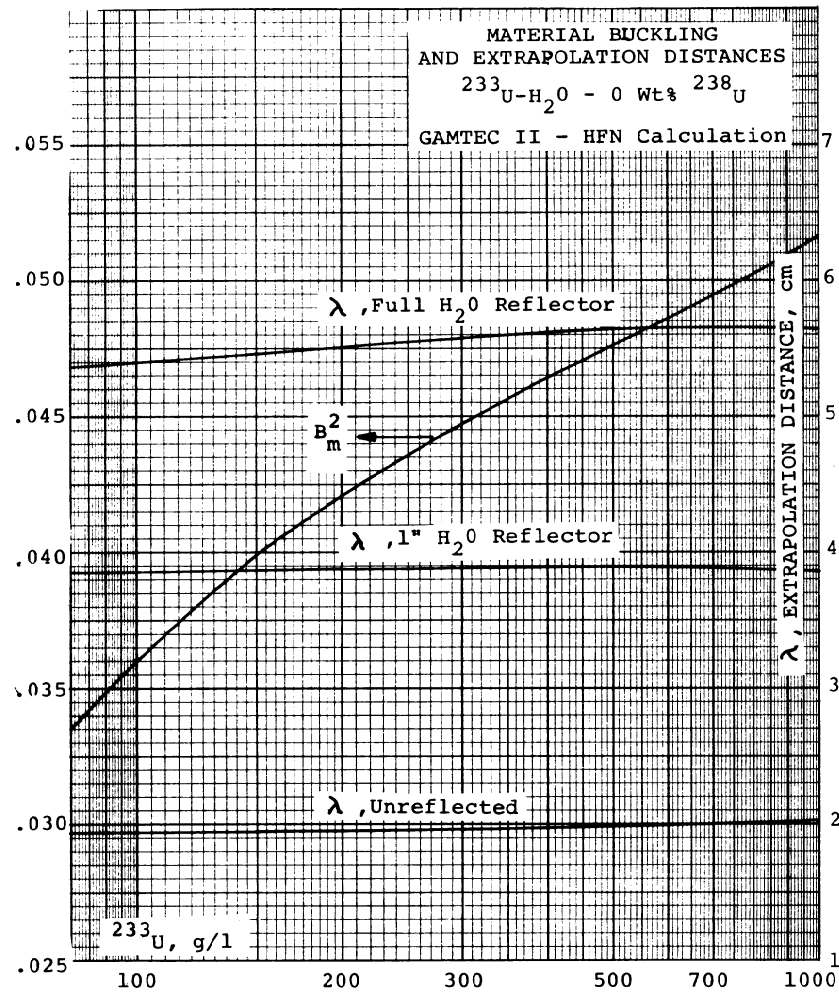
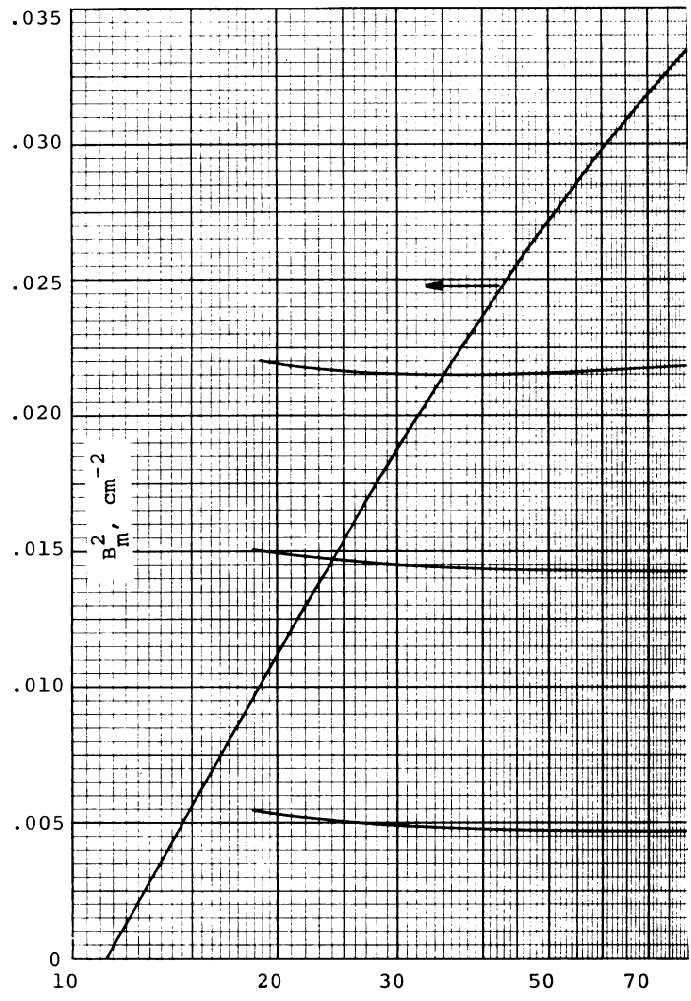

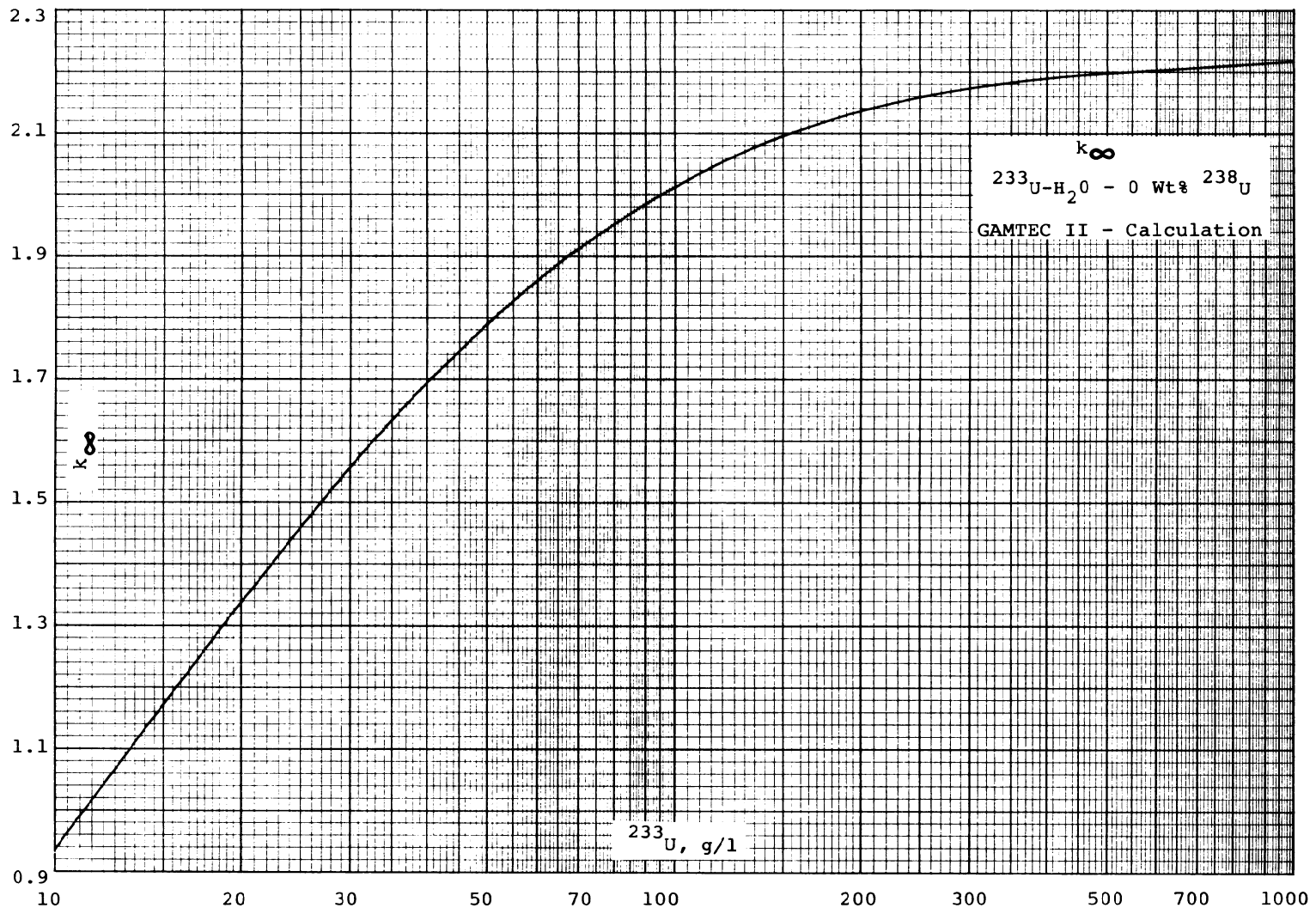

III. HOMOGENEOUS DATA

D. MIXED AND MISCELLANEOUS SYSTEMS

1. Correlation Between Calculation and Experiment
2. H/X versus Fissile* g/l Relationship
3. Critical Sphere Dimensions

All graphs within this and following divisions have the percentage by weight of the major fissile-atom-containing component as the fourth identification number. For example, III.D.3(3)-1 might signify a graph showing data for a $\text{PuO}_2\text{-UO}_2$ mixture containing 3 weight percent PuO_2 with the uranium being either natural or depleted, while III.D.3(3)-2 might show data for material containing 3 weight percent U-233 in thorium.

4. Critical Cylinder Dimensions
5. Critical Slab Dimensions
6. Critical Mass - Sphere
7. Critical Mass per Unit Height - Cylinder
8. Critical Mass per Unit Area - Slab
9. Critical Volume
10. Material Bucklings and Infinite Multiplication Factor

*In this book fissile atoms are those which can sustain a chain reaction in at least one condition. Fissionable atoms are defined as those which can be made to fission but may or may not (e.g., ²³⁸U) be capable of forming a critical mass.

III.D.1 Correlations Between Theory and Experiment

The primary means of producing the critical parameters in this section were the GAMTEC II code for the 18-group cross section sets and the HFN diffusion theory code for the critical parameters (some additional checks were made with the DTF-IV code). At this writing only critical parameters for plutonium-natural uranium mixtures with the plutonium consisting of only ^{239}Pu have been calculated. This limitation was set because correlation of calculation and experiment found that calculated k-effective values were consistently low when large fractions of ^{240}Pu , ^{241}Pu , and ^{242}Pu were involved (see pp. III.A.1-3 to -5.) if the calculation assumed that the ^{239}Pu represented the ^{239}Pu and ^{241}Pu and the ^{240}Pu represented the ^{240}Pu and the ^{242}Pu . However, recent experiments with plutonium-uranium nitrate solutions (1) have provided a good correlational basis for mixture calculations and two-isotope calculations do not appear to be as low as the plutonium-only data indicated (possibly because of compensating errors).

The uranium and plutonium analysis is shown in Table I for both the actual composition (in weight percent) and those used for the calculations. Only the single plutonium composition was used for the sphere calculations because the amount of the 238, 241, and 242 plutonium isotopes was not considered significant.

(1)R. C. Lloyd, et. al., "Critical Parameters of Plutonium-Uranium Nitrate Solutions," Transactions of the American Nuclear Society, 15, 803, 1972.

TABLE I

<u>All Experiments</u>	<u>Actual</u>	<u>Calculations Used</u>	
^{234}U	0.01	0	0
^{235}U	0.66	0.66	0.66
^{236}U	0.01	0	0
^{238}U	99.32	99.34	99.34
 <u>Sphere Experiments</u>			
^{238}Pu	0.01	0	---
^{239}Pu	95.09	95.09	---
^{240}Pu	4.66	4.68	---
^{241}Pu	0.22	0.22	---
^{242}Pu	0.01	0.01	---
 <u>Cylinder Experiments</u>		<u>(2-Iso)</u>	<u>(5-Iso)</u>
^{238}Pu	0.07	0	0.07
^{239}Pu	73.00	76.22	73.00
^{240}Pu	22.80	23.78	22.80
^{241}Pu	3.22	0	3.22
^{242}Pu	0.91	0	0.91

The computer codes used included HFN, DTF-IV, and KENO (all with GAMTEC II generated cross section decks) and HAMMER. The data is shown in Table II. Additional details may be found in the reference. The sphere was fully reflected by water and the cylinder was fully reflected on the radius and the base.

Previous experience has shown the Δk effect of the gadolinium to be less than calculated. Therefore, the calculated k-effective for the spheres would be expected to be slightly higher if no gadolinium were present. The total calculated gadolinium effect is 2.2, 2.3, and 0.3 percent k-effective, therefore, the adjustment would be small.

The differences in k-effective between the two isotope and five-isotope calculations are .0154, .0152, .0150, .0150, and .0150.

This compared to values greater than 0.03 that might be expected at 25 percent $^{240}\text{Pu} + ^{242}\text{Pu}$ based on the correlation in section III.A.1. The two-isotope calculations are also low by less than one percent k-effective compared to a predicted value of nearly two percent in III.A.1. These smaller differences may be due to the presence of large amounts of ^{238}U .

Based on these correlations it now appears feasible to calculate critical parameters for mixed solutions with up to 25 percent $^{240}\text{Pu} + ^{242}\text{Pu}$ with a one percent or less correction factor in k-effective.

W. E. Matheison
R. D. Carter
July 1, 1973

TABLE II

	<u>Sphere</u>			<u>Cylinder</u>				
Wall Thick., cm	0.112	0.122	0.122	0.079	0.079	0.079	0.079	0.079
Base Thick., cm	-----	-----	-----	0.9525	0.9525	0.9525	0.9525	0.9525
Radius, cm	17.869	19.304	19.314	30.514	30.514	30.514	30.514	30.514
Critical Height, cm	-----	-----	-----	50.27	54.66	61.04	70.49	84.86
U, g/l	157.1	75.7	264.9	390.2	394.5	399.0	403.3	407.1
Pu, g/l	70.93	35.05	45.6	30.63	29.00	27.32	25.71	24.28
Gd, g/l	0.051	0.025	0.005	-----	-----	-----	-----	-----
HNO ₃ , M	3.12	1.49	2.1	0.45	0.44	0.44	0.37	0.36

Two Isotopes For Pu and Two For U

HFN-GAMTEC II	-----	-----	-----	0.9942	0.9922	0.9918	0.9922	0.9919
---------------	-------	-------	-------	--------	--------	--------	--------	--------

Five Isotopes For Pu and Two For U

HFN-GAMTEC II	1.0071	1.0081	1.0062	1.0096	1.0074	1.0068	1.0072	1.0069
DTF-GAMTEC II	-----	1.0216	-----	-----	-----	-----	-----	-----
HAMMER	-----	1.029	1.024	-----	-----	-----	-----	-----
KENO-GAMTEC II	1.017	1.007	0.992	1.003	1.003	1.002	1.014	1.006
	±.008	±.008	±.008	±.007	±.008	±.007	±.005	±.004
(neutron history)	9400	9400	9400	9600	10,000	10,000	13,000	14,000

III.D.2 H/(U+Pu) Versus g(U+Pu)/l Relationships

The critical parameters in this section were calculated from the general relationship shown on page II.C.3-1 and the values in the table on page II.C.3-2. No denitration effect was assumed for the nitrate solutions. The relationships are shown graphically on pages III.D.2-2 and III.D.2-3.

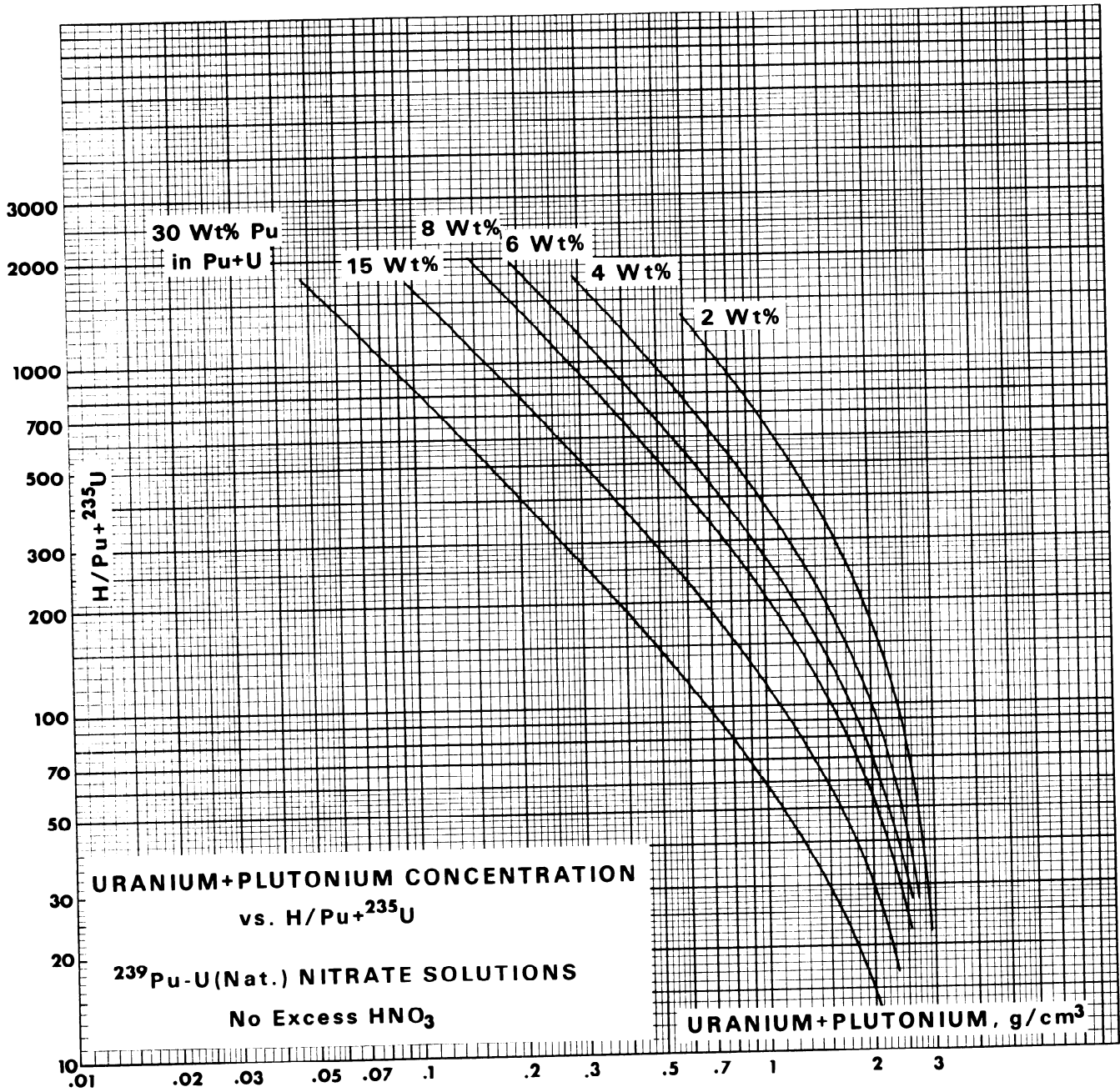

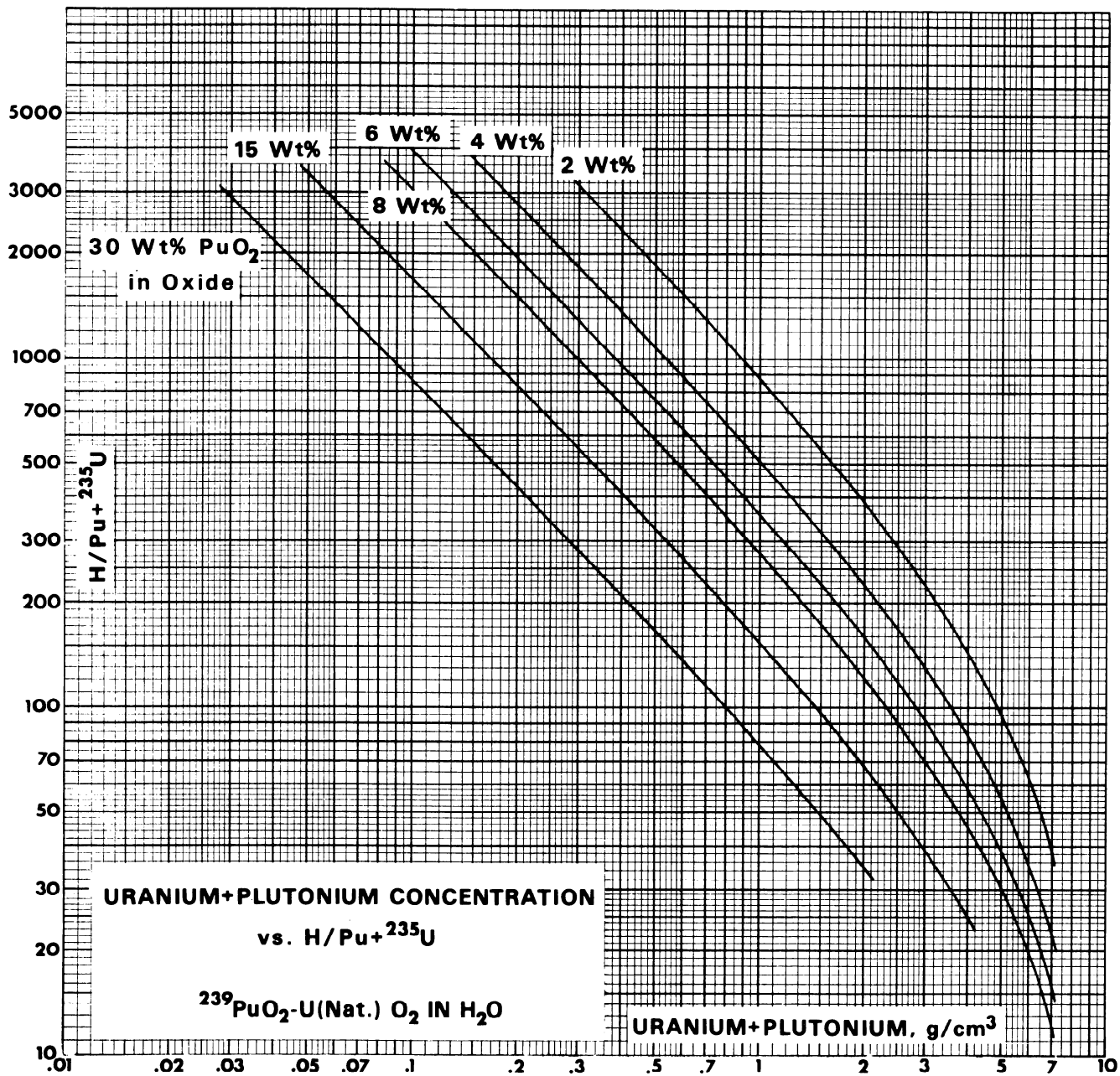

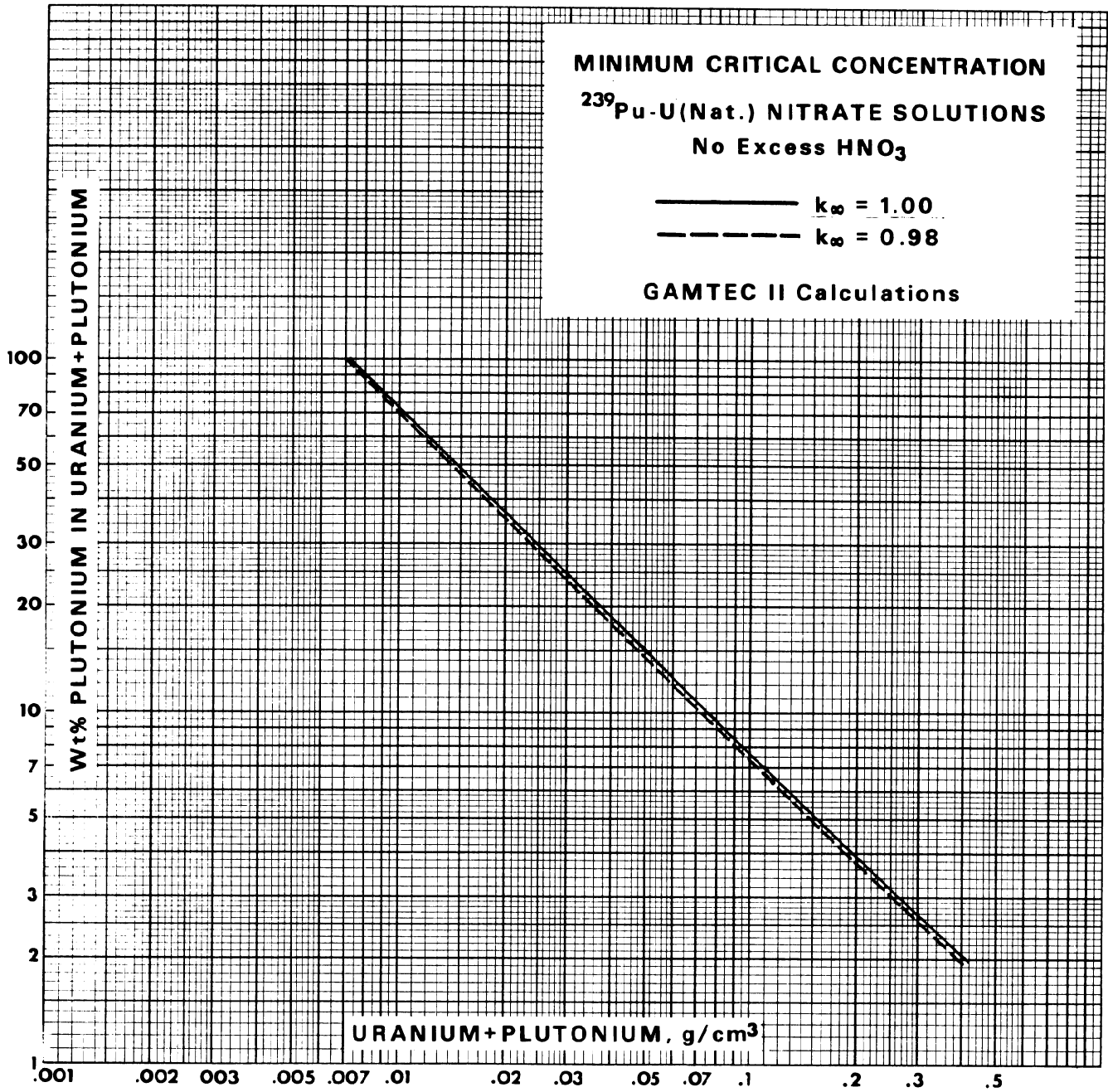

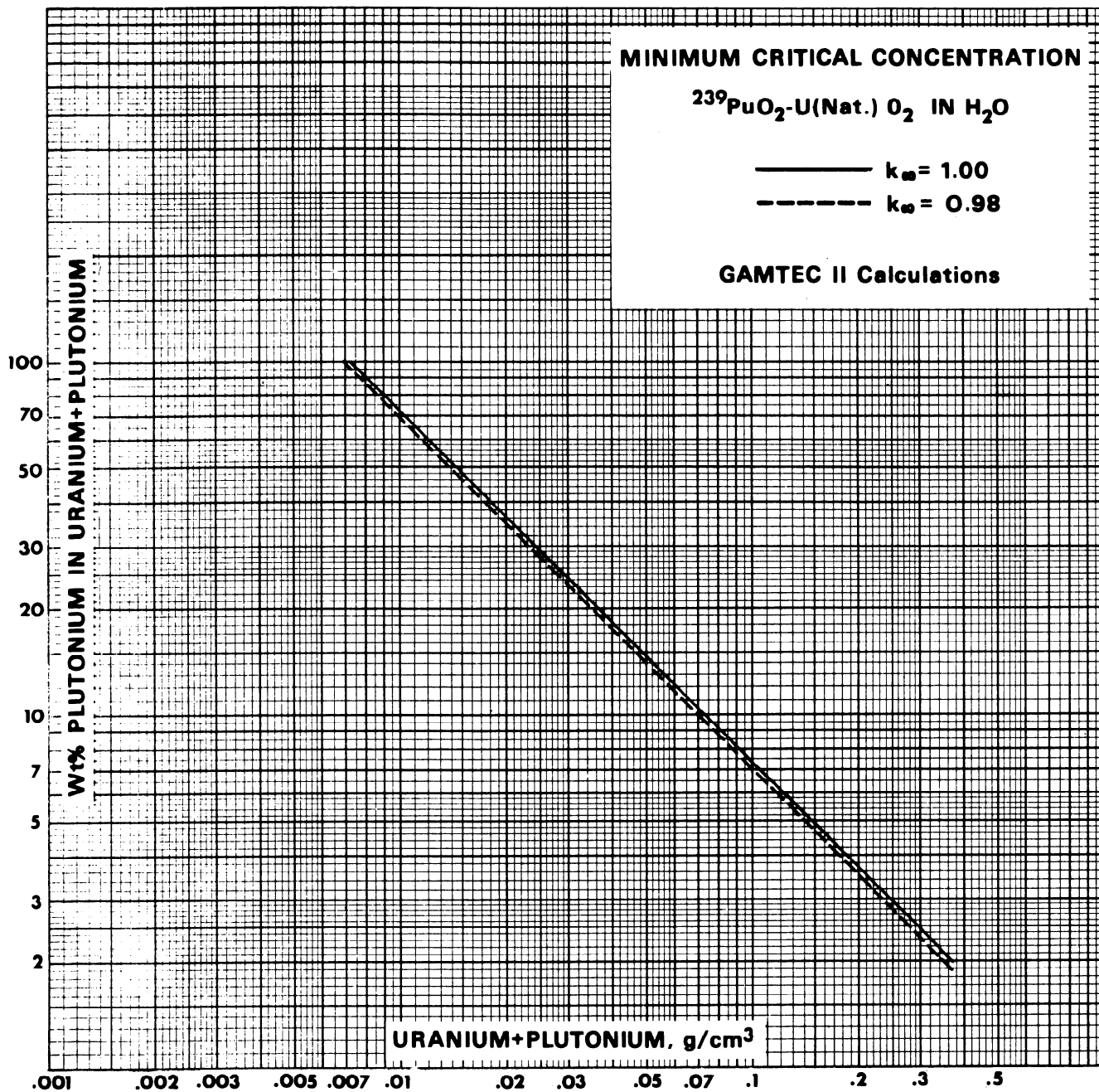

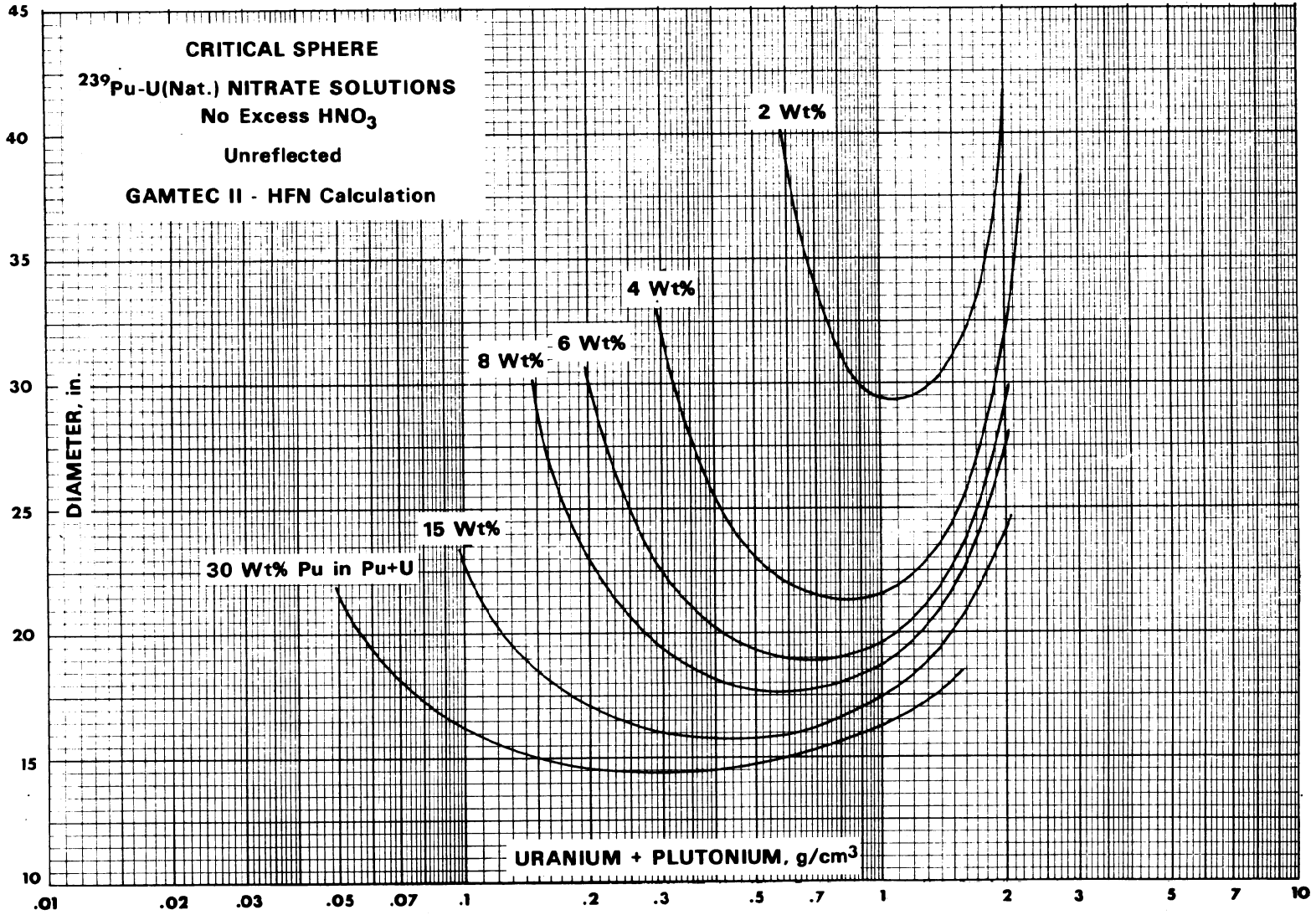

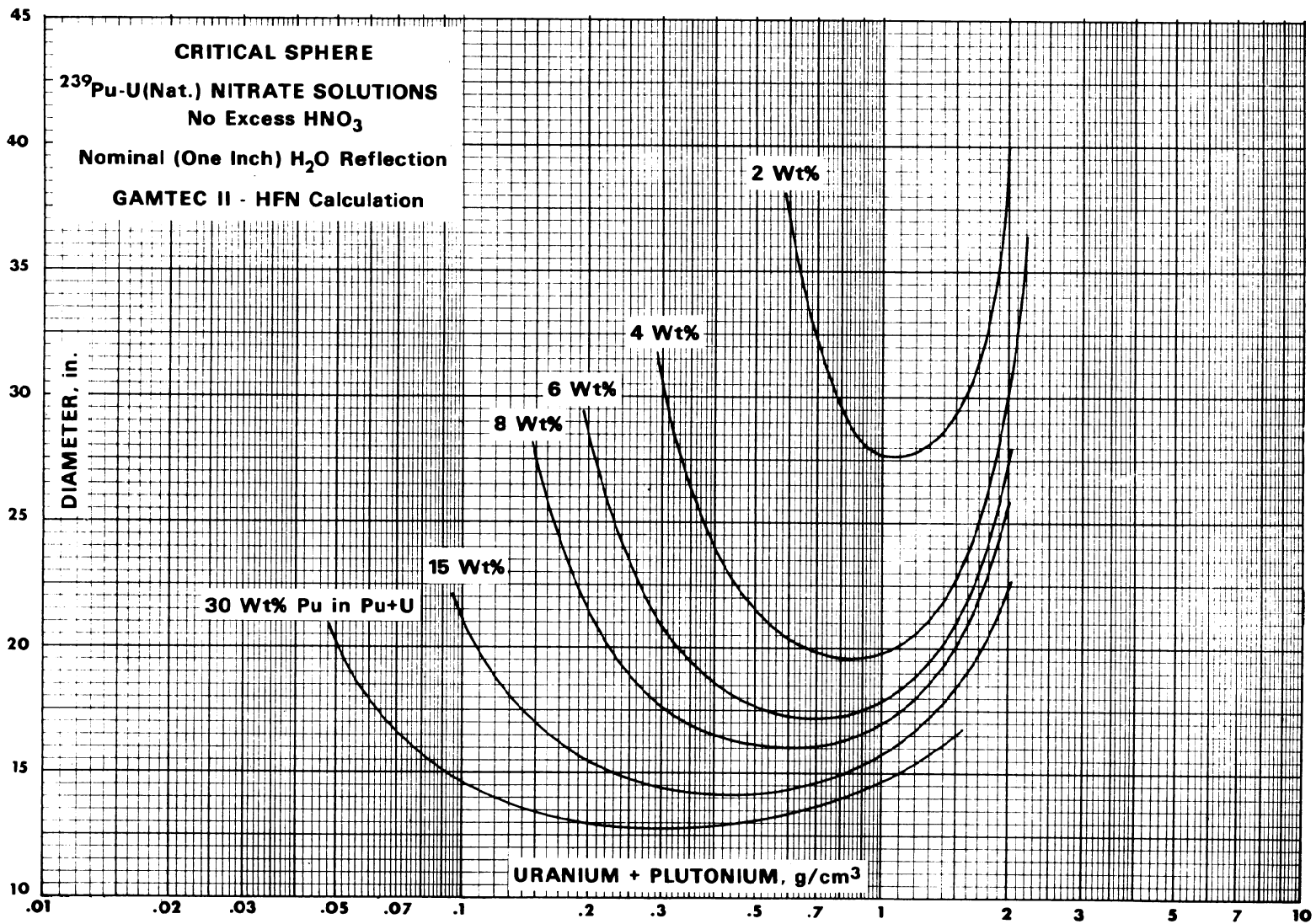

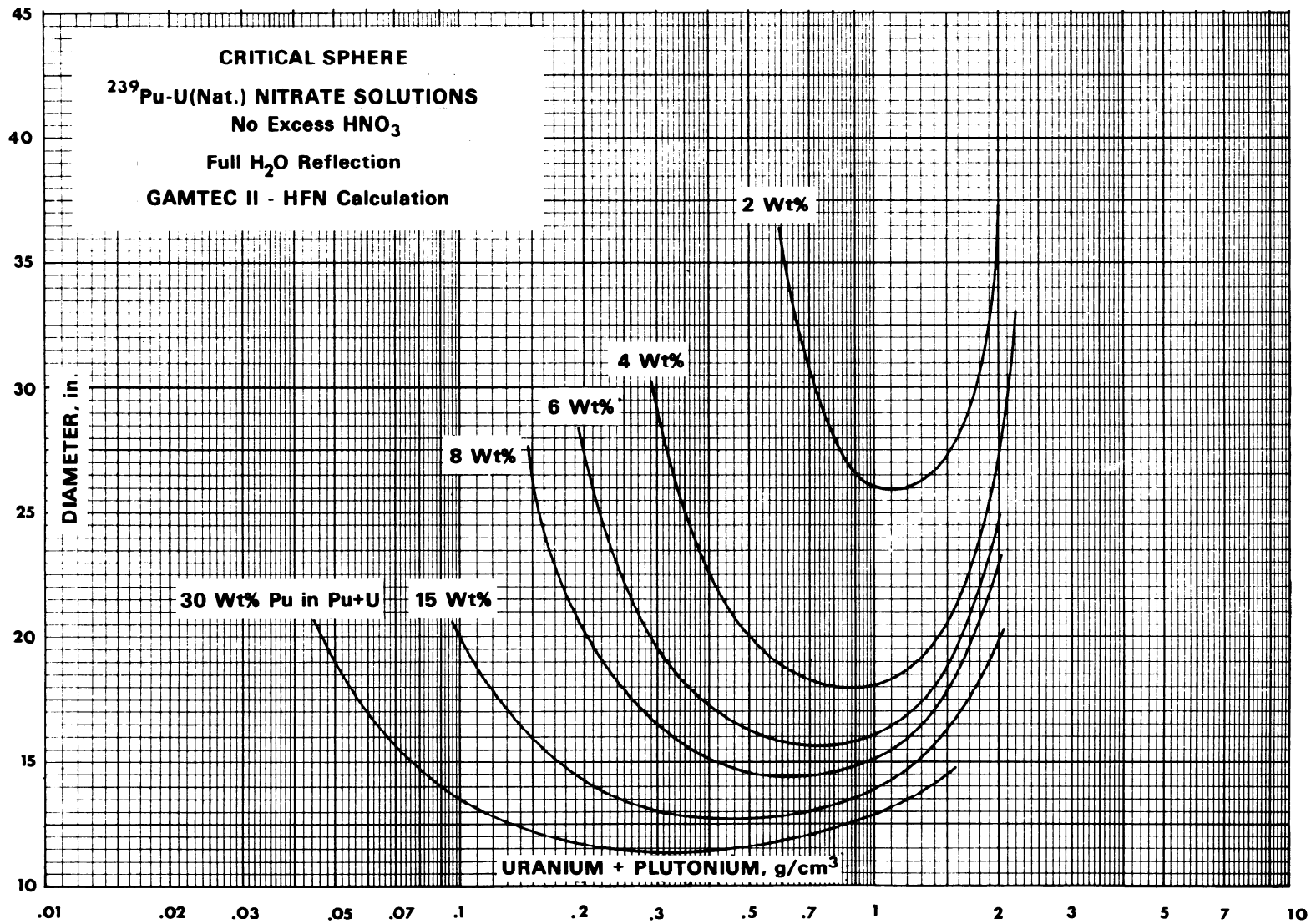

III.D.3-3

ARRH-600

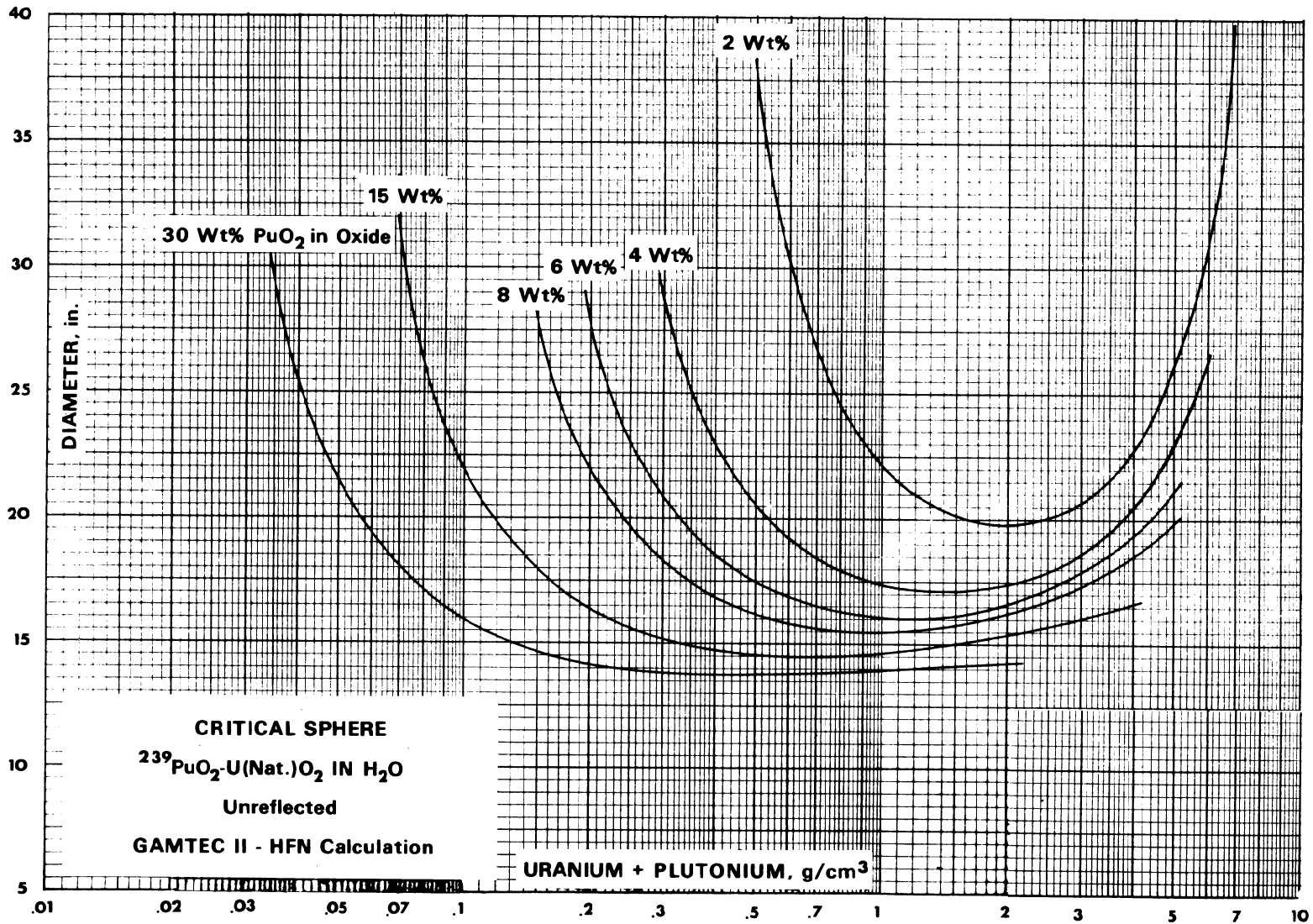

III.D.3-4

ARH-600

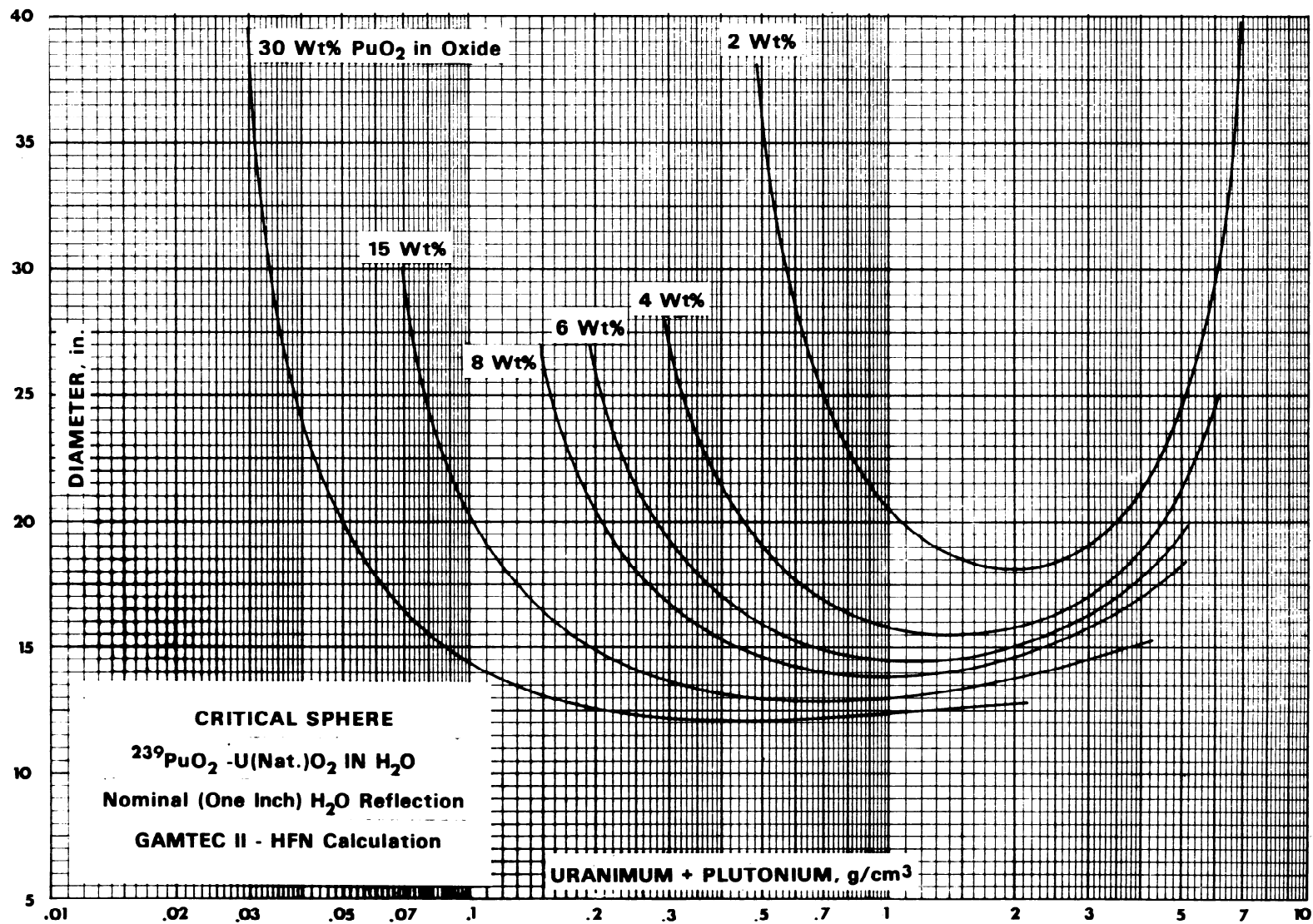

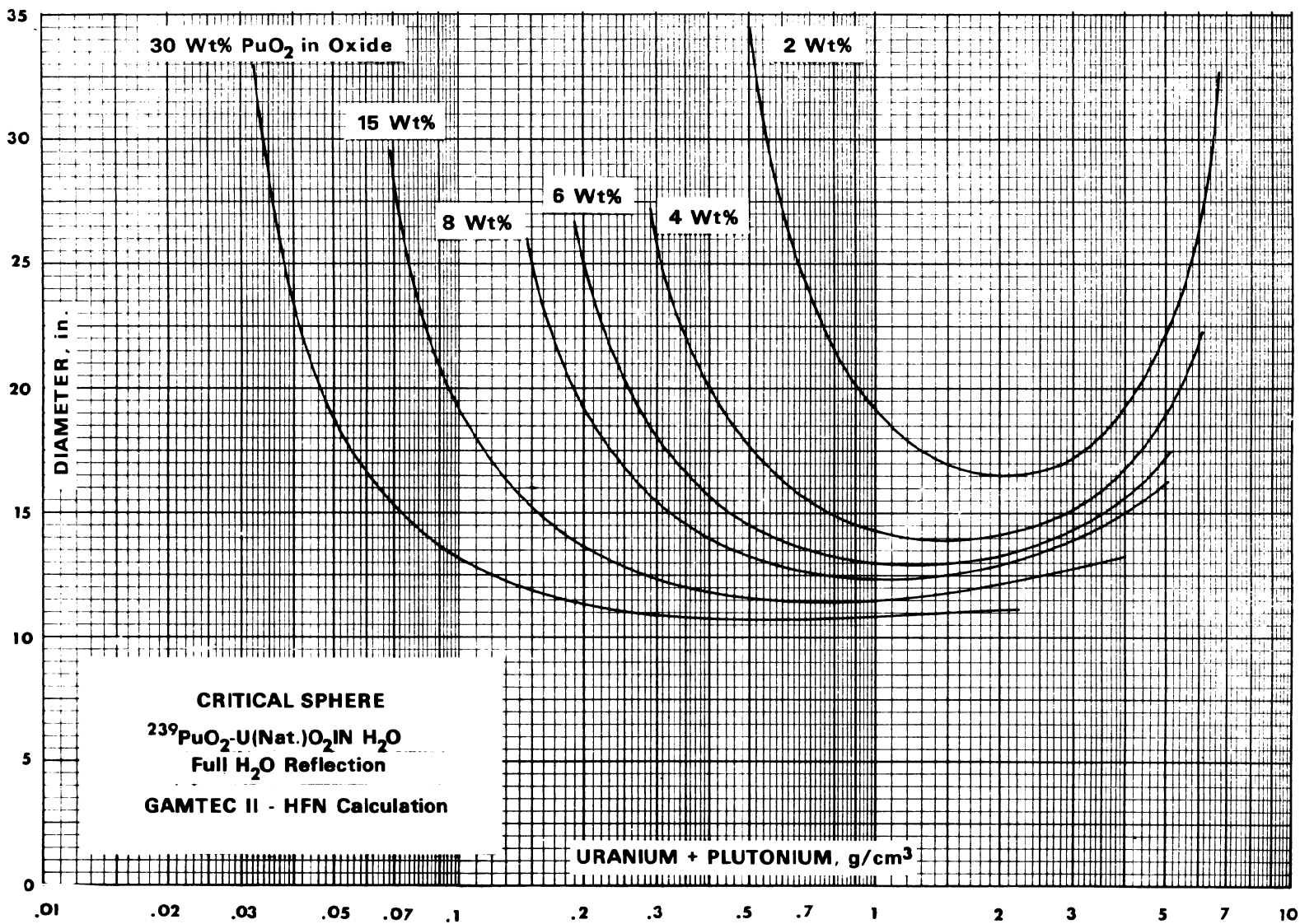

III.D.3-6

ARRH-600

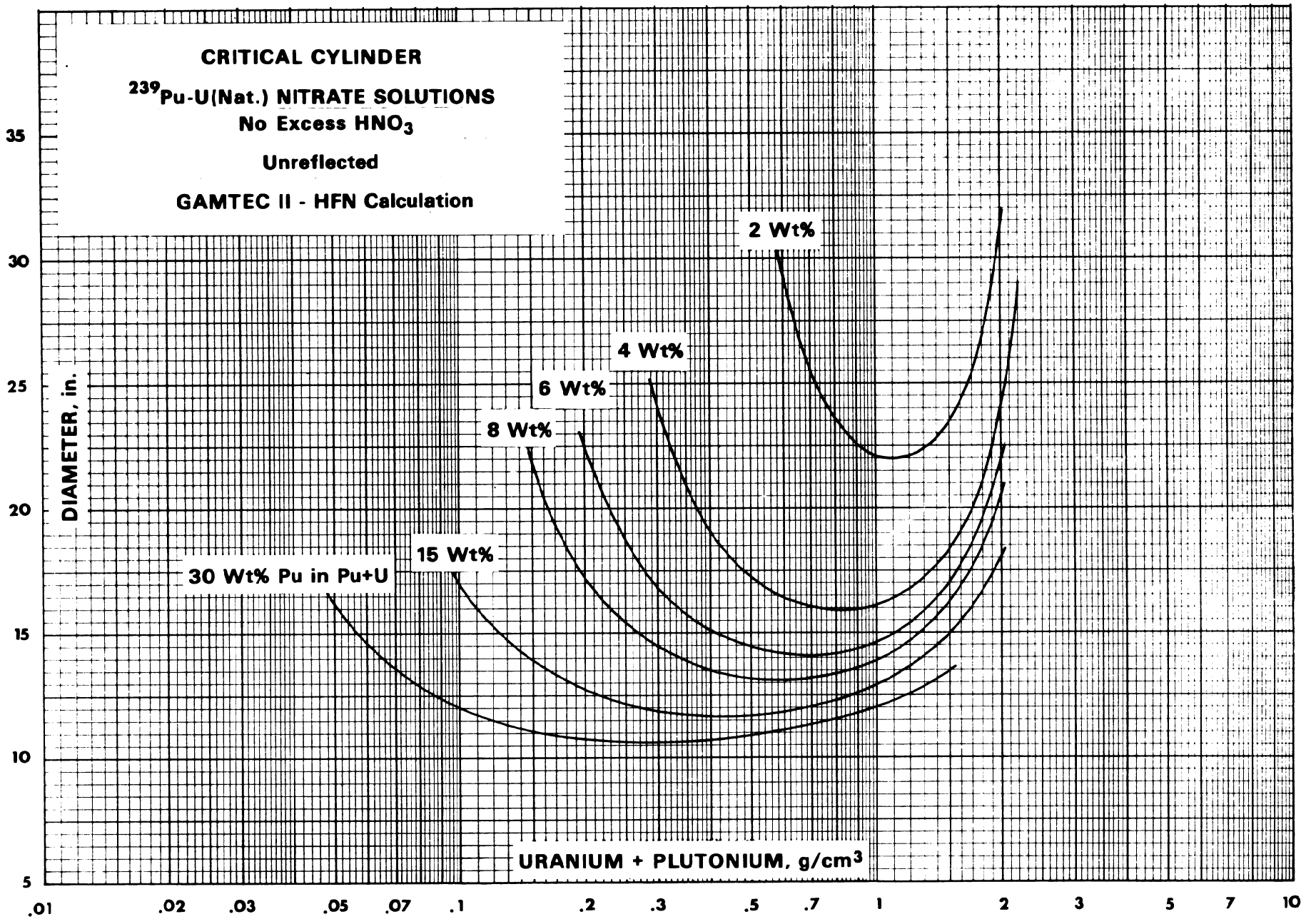

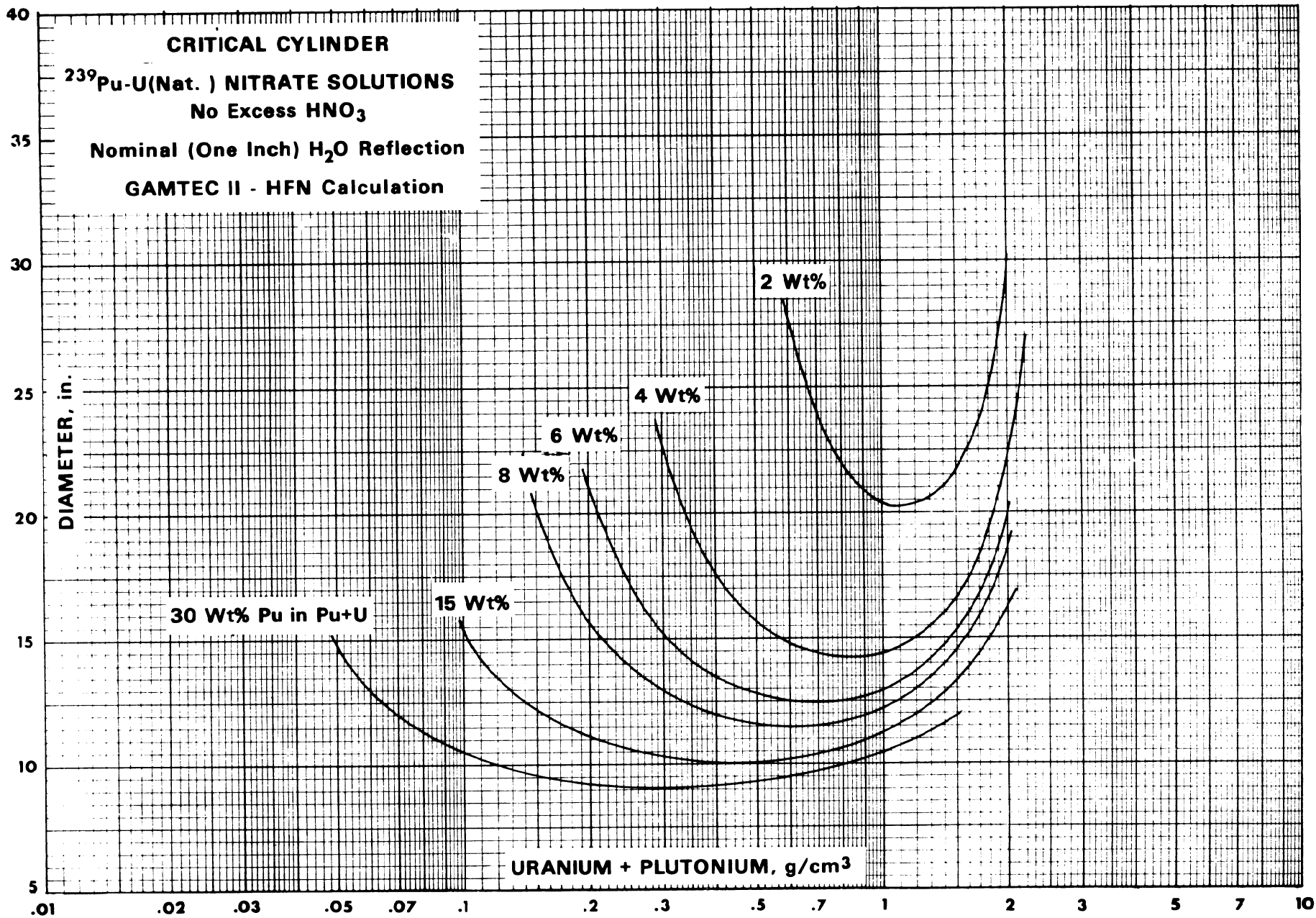

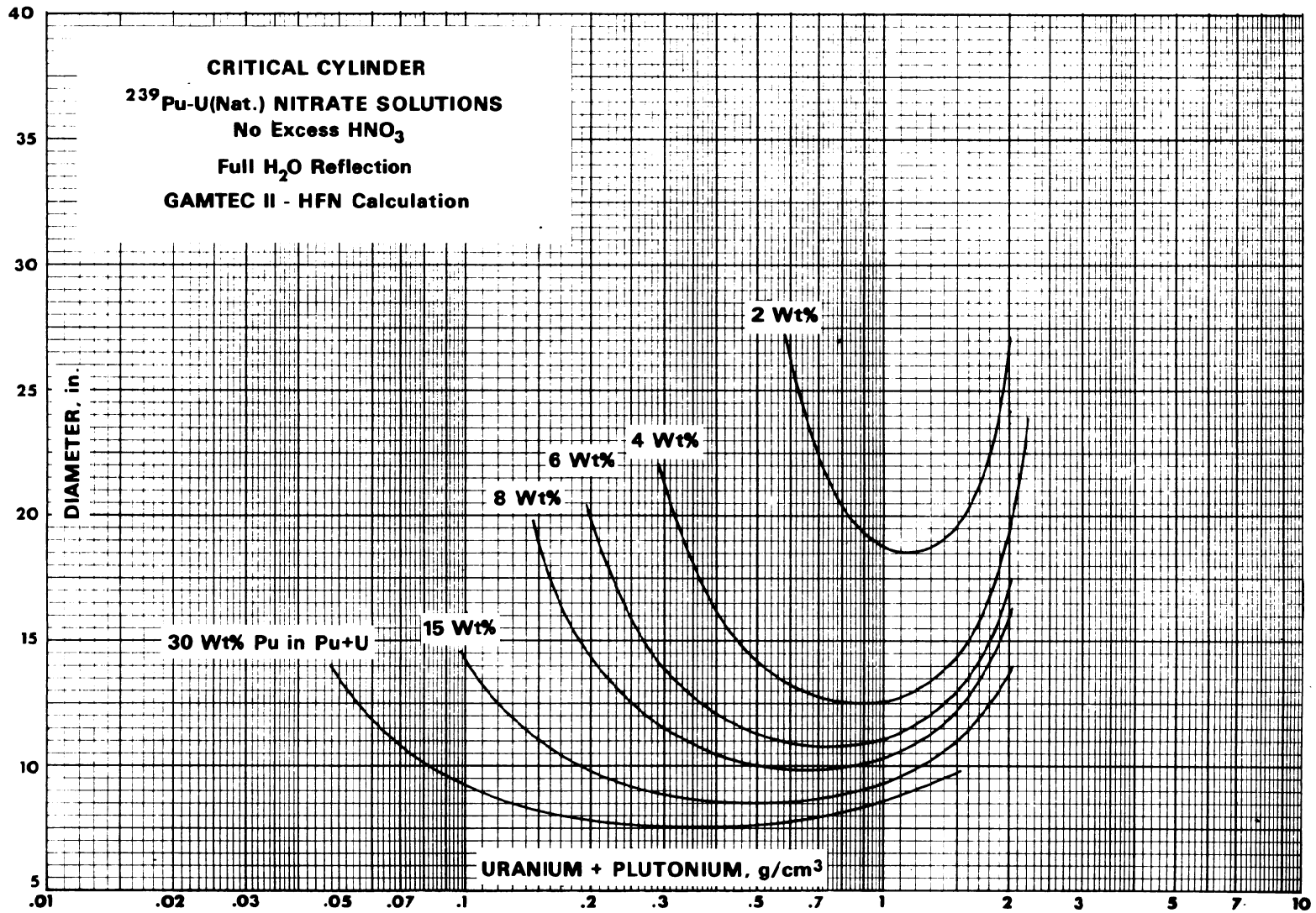

III.D.4-3

ARR-600

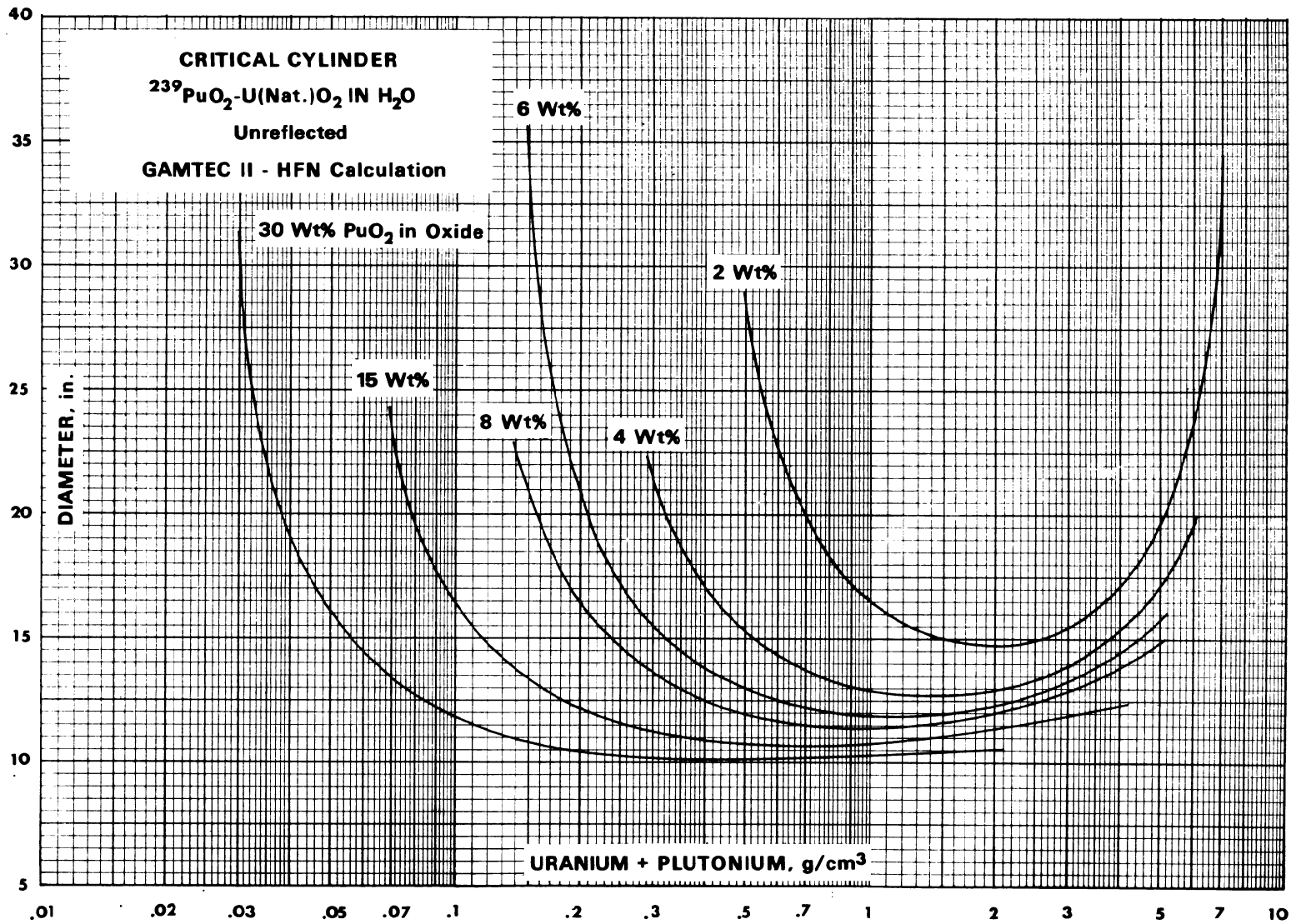

III.D.4-4

ARRH-600

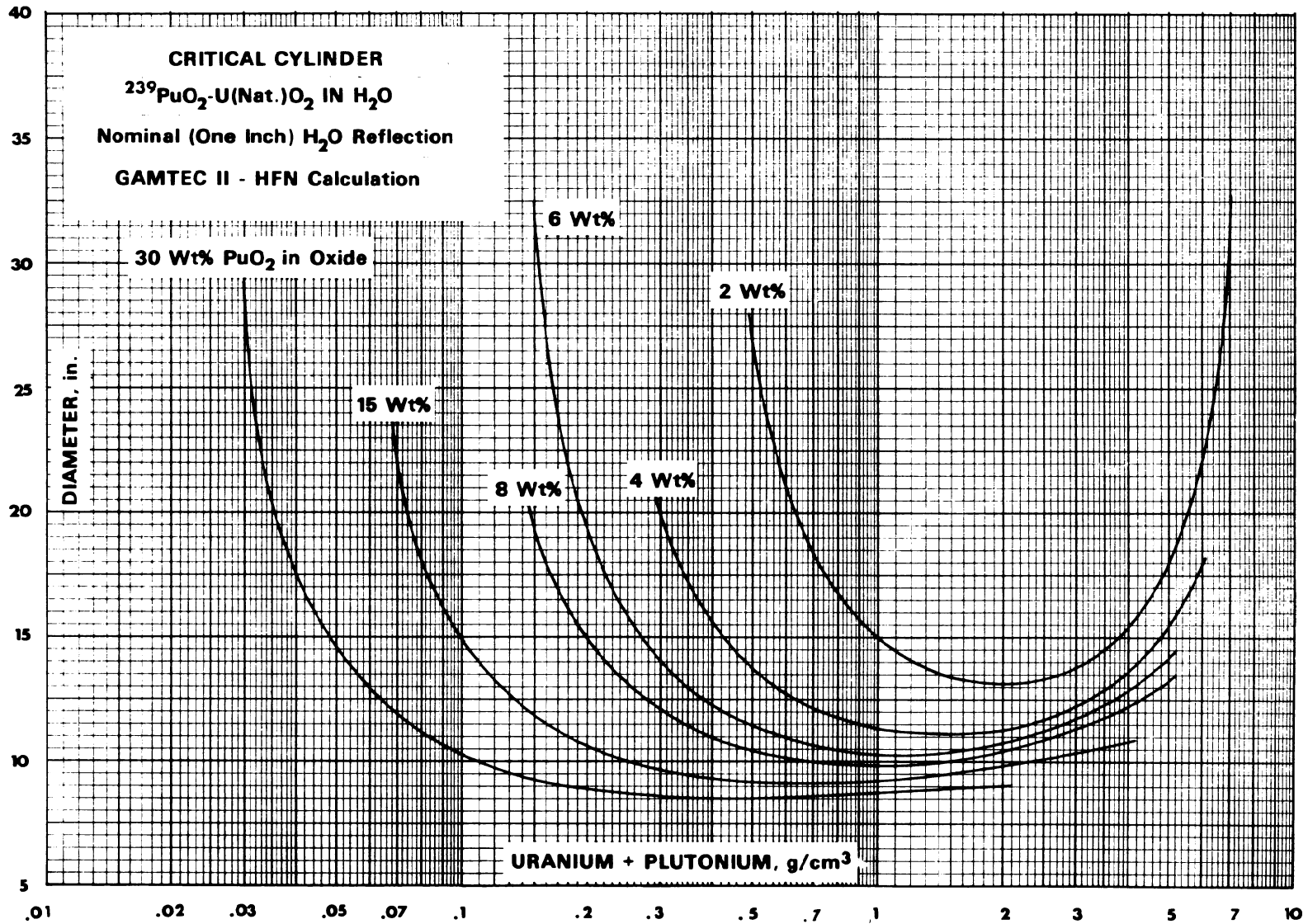

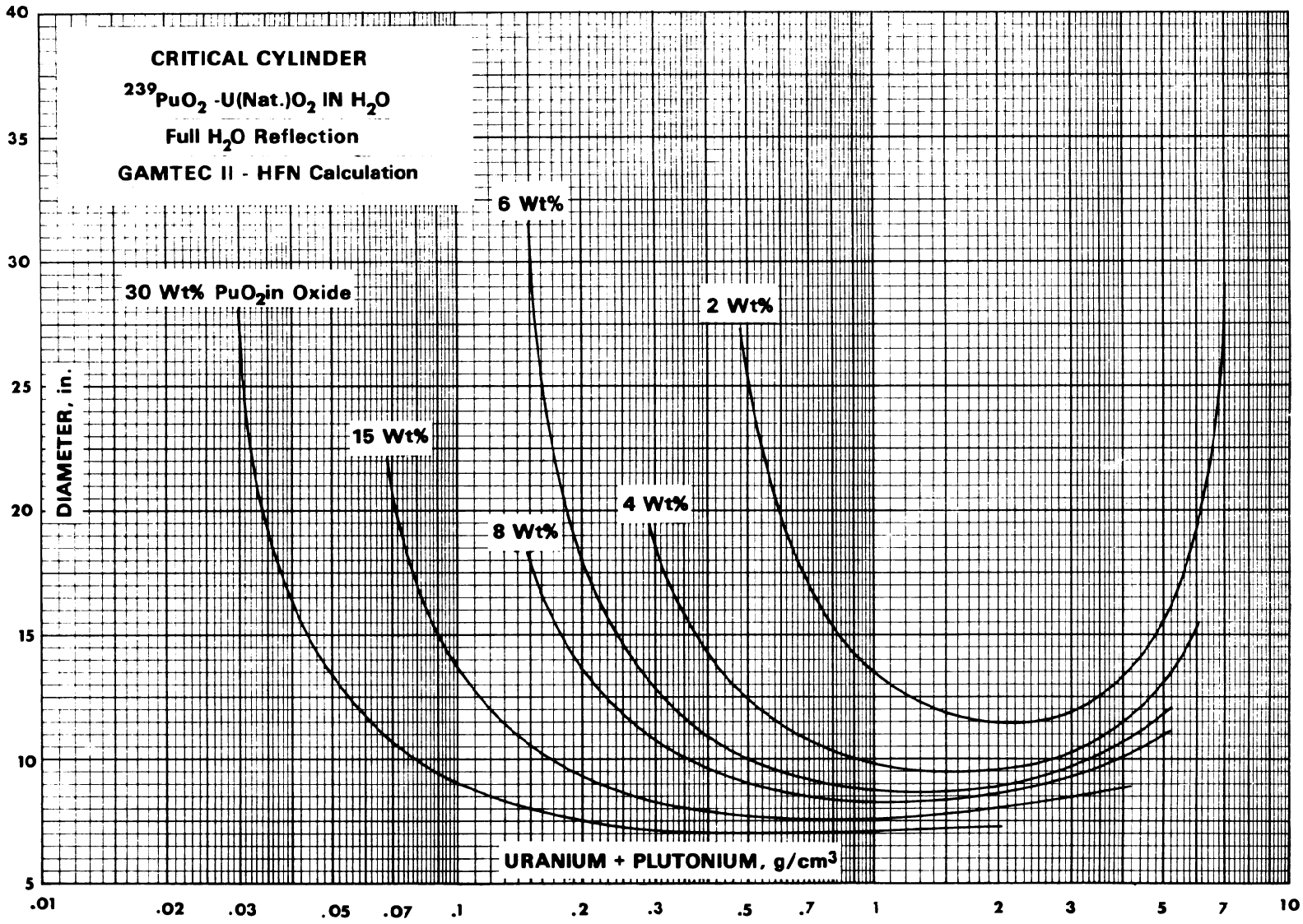

III.D.4-6

ARRH-600

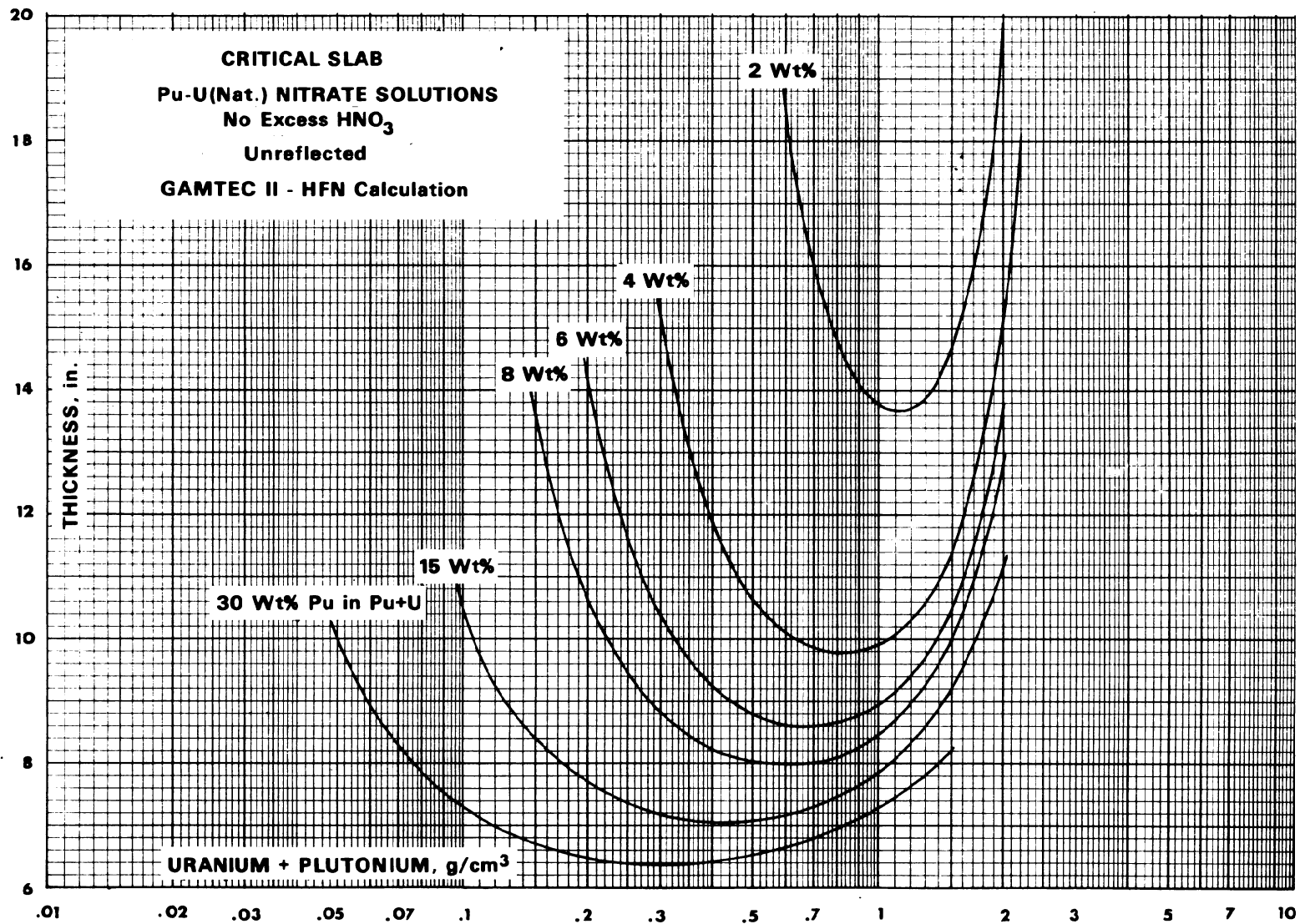

III.D.5-1

ARR-600

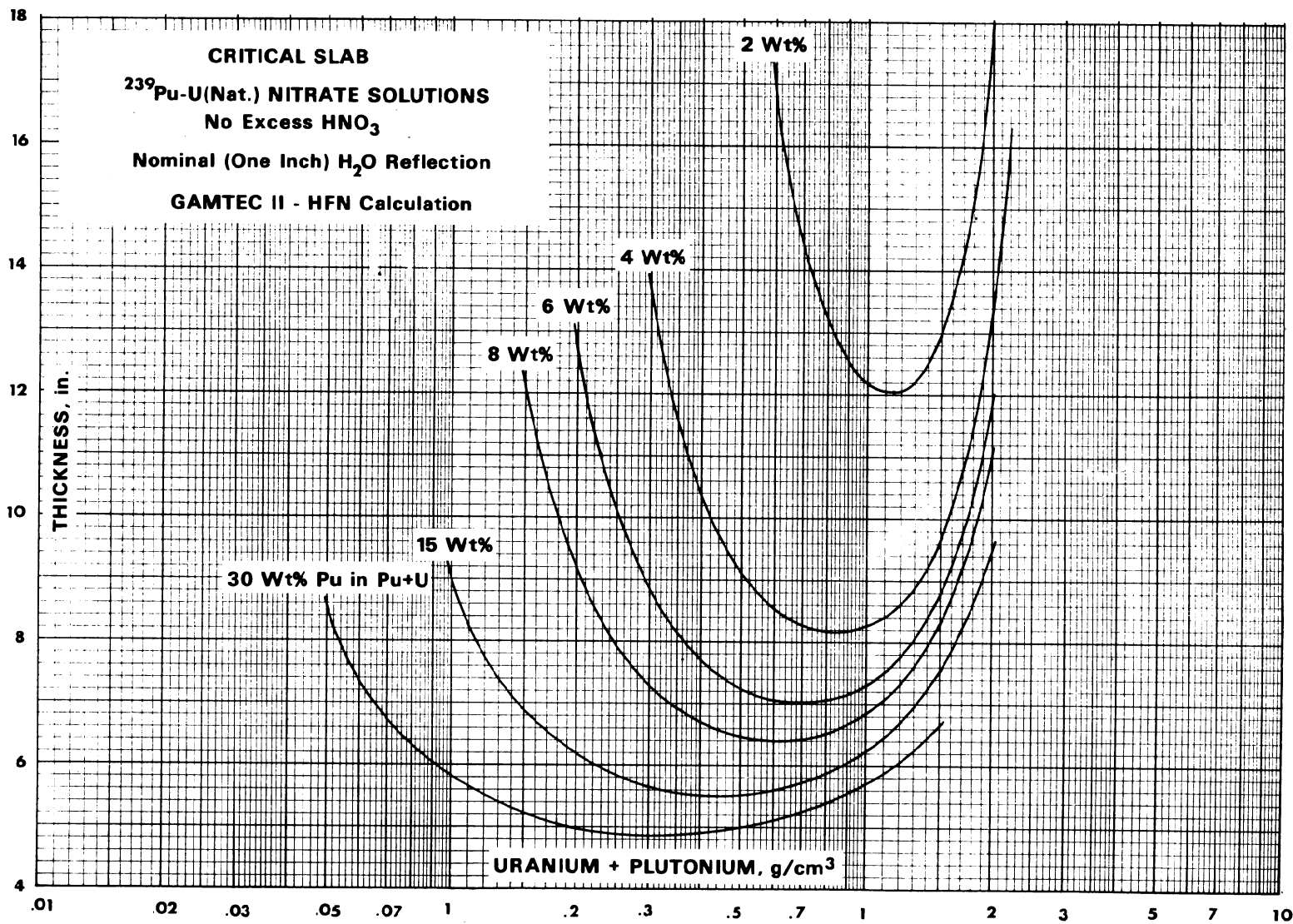

III.D.5-2

ARRH-600

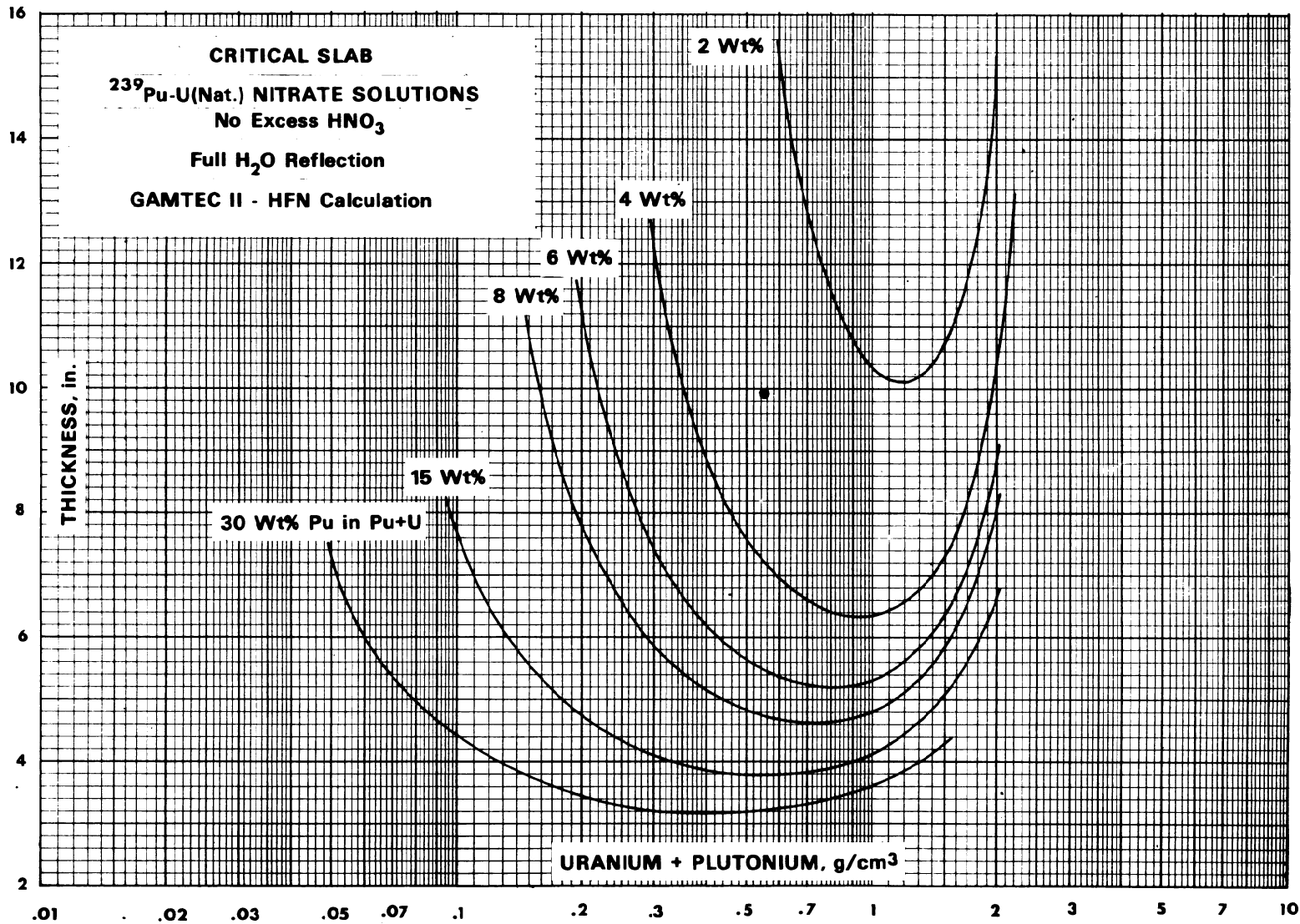

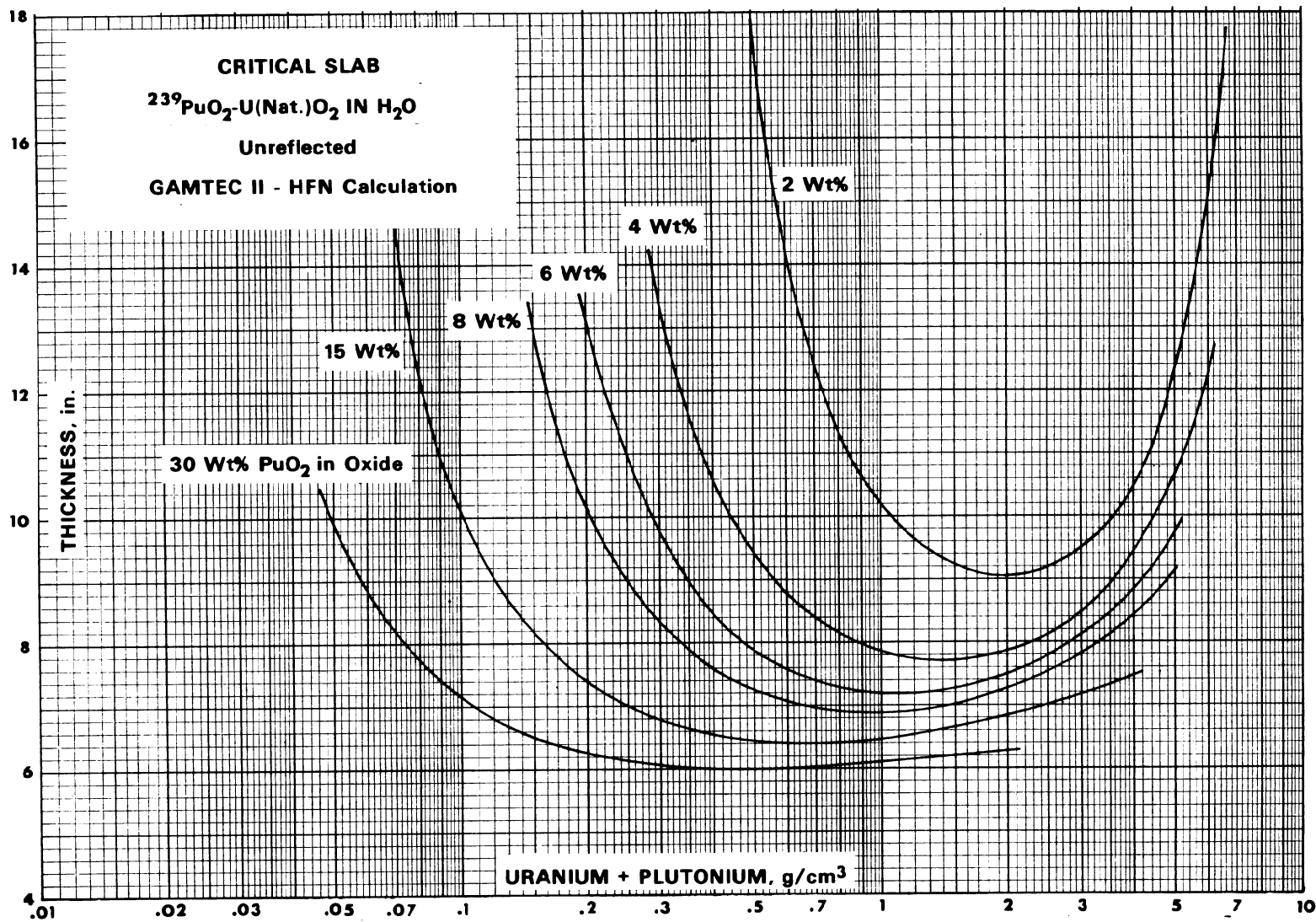

III.D.5-4

ARRH-600

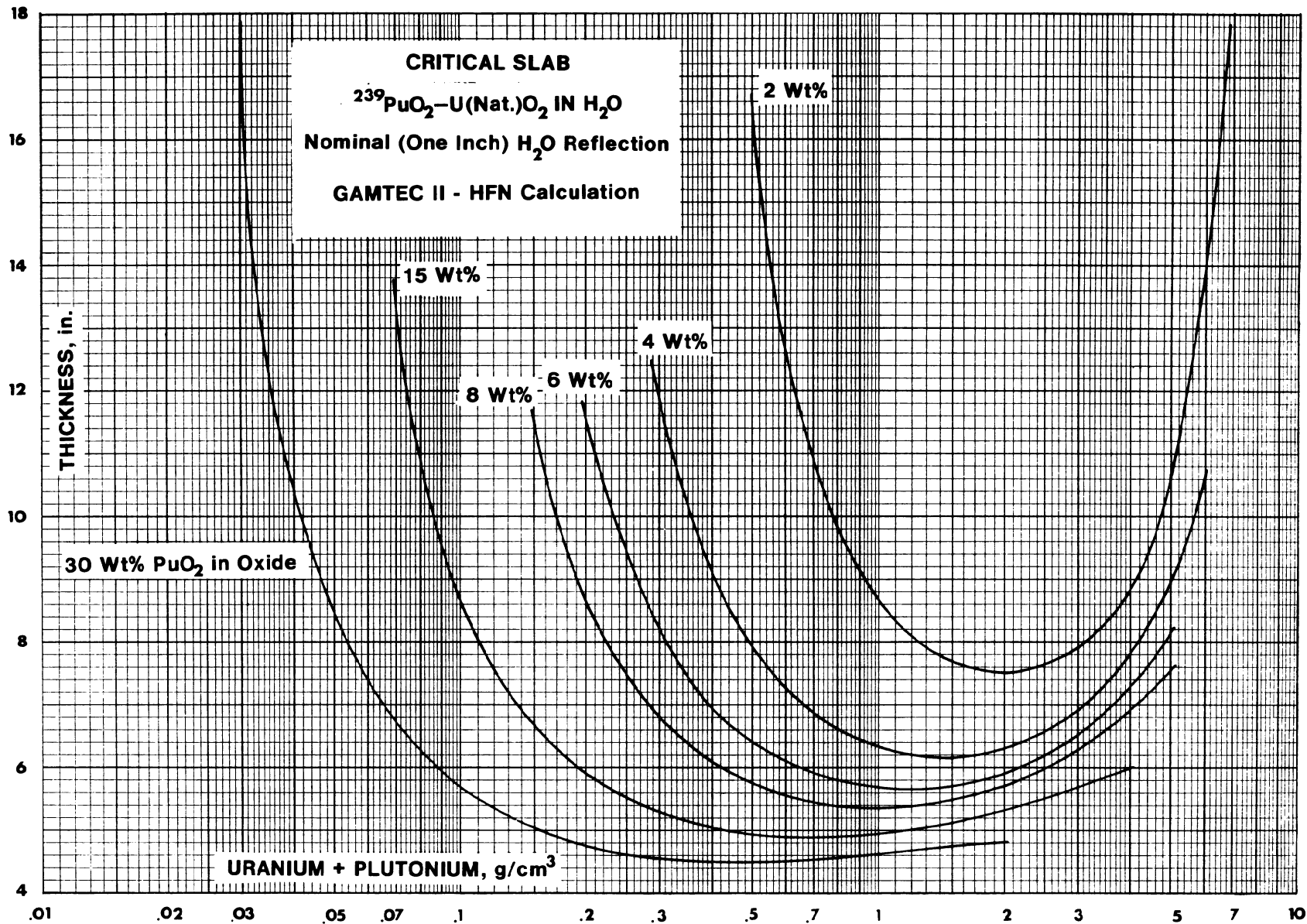

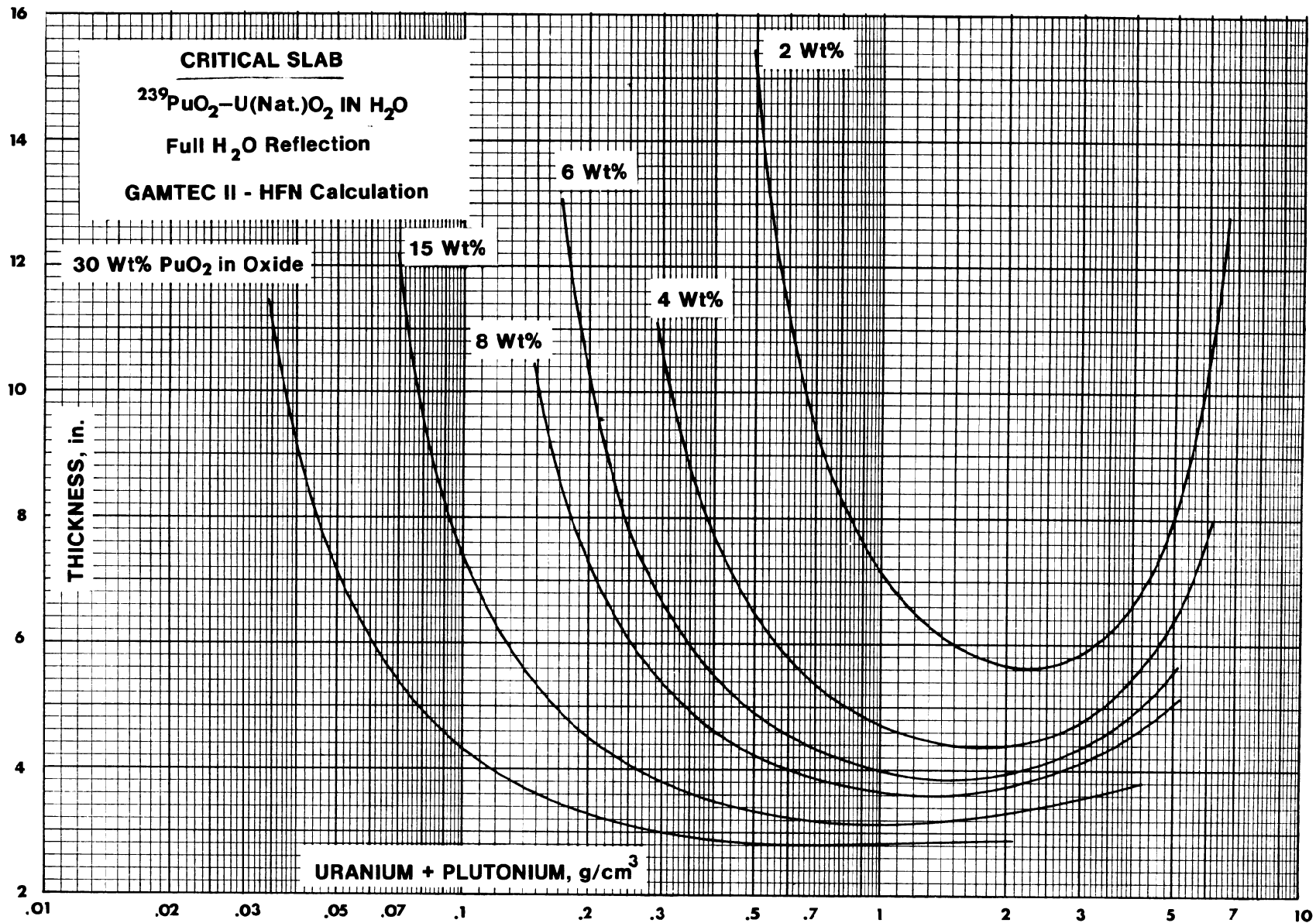

III.D.5-6

ARRH-600

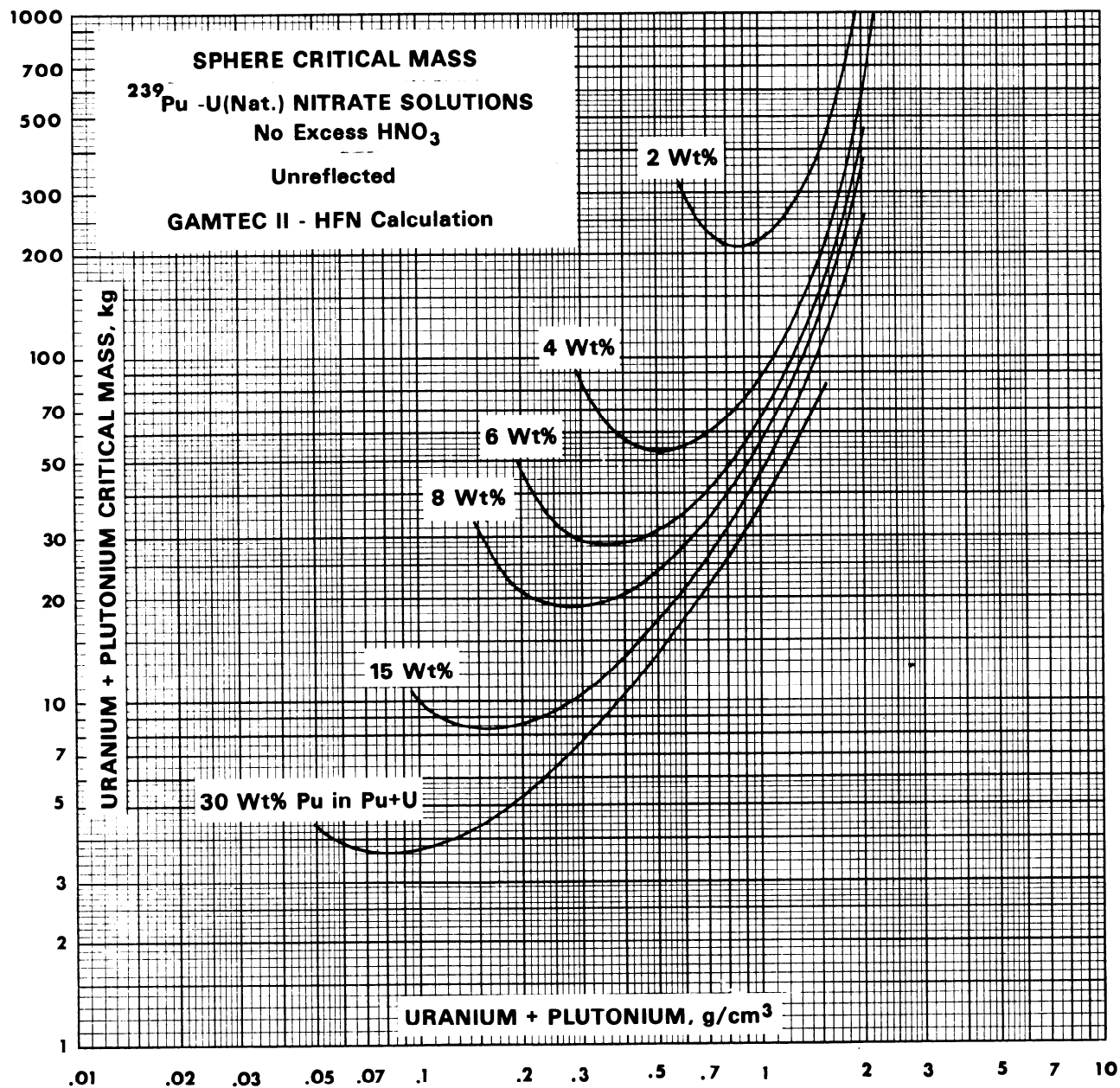

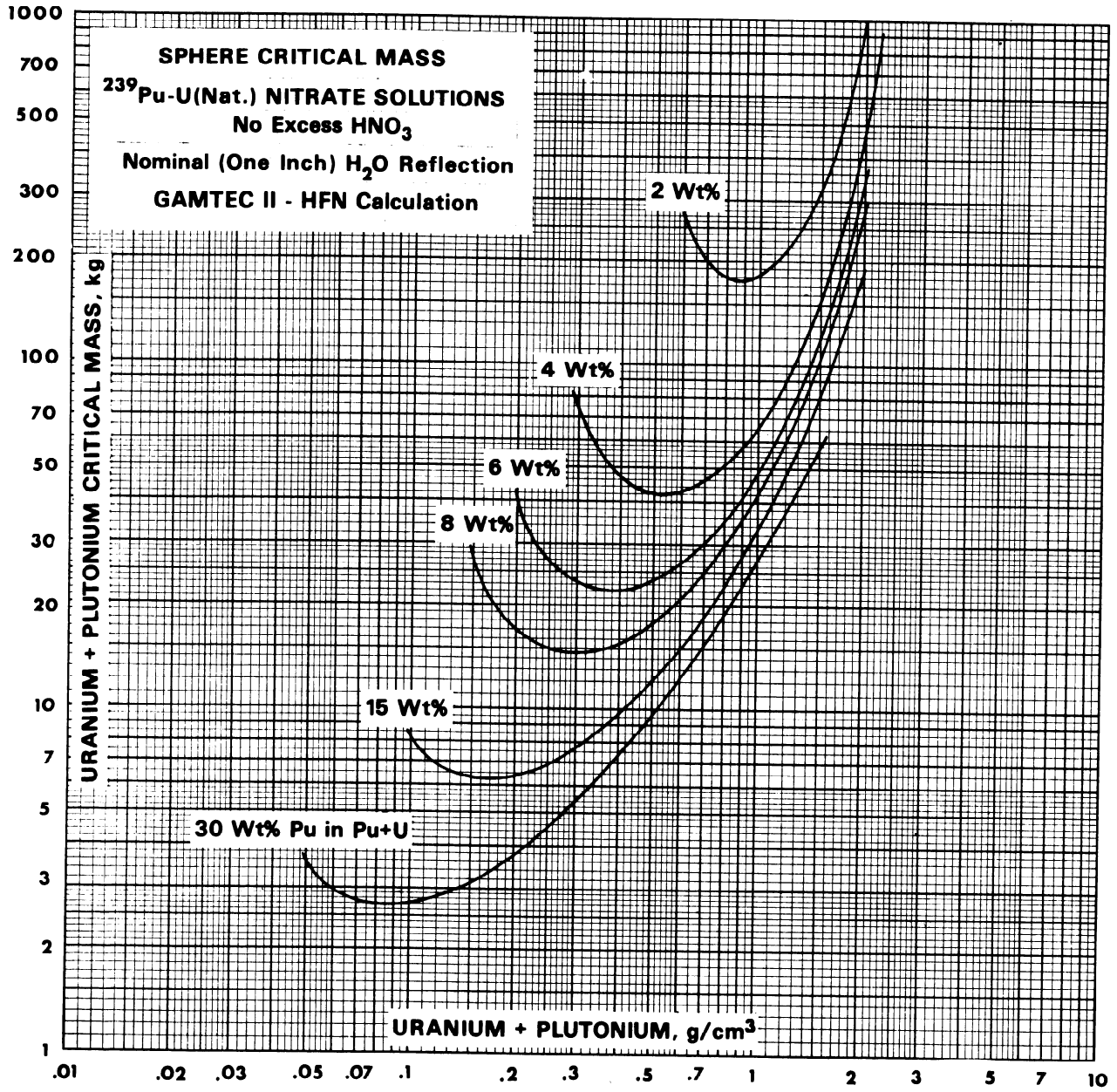

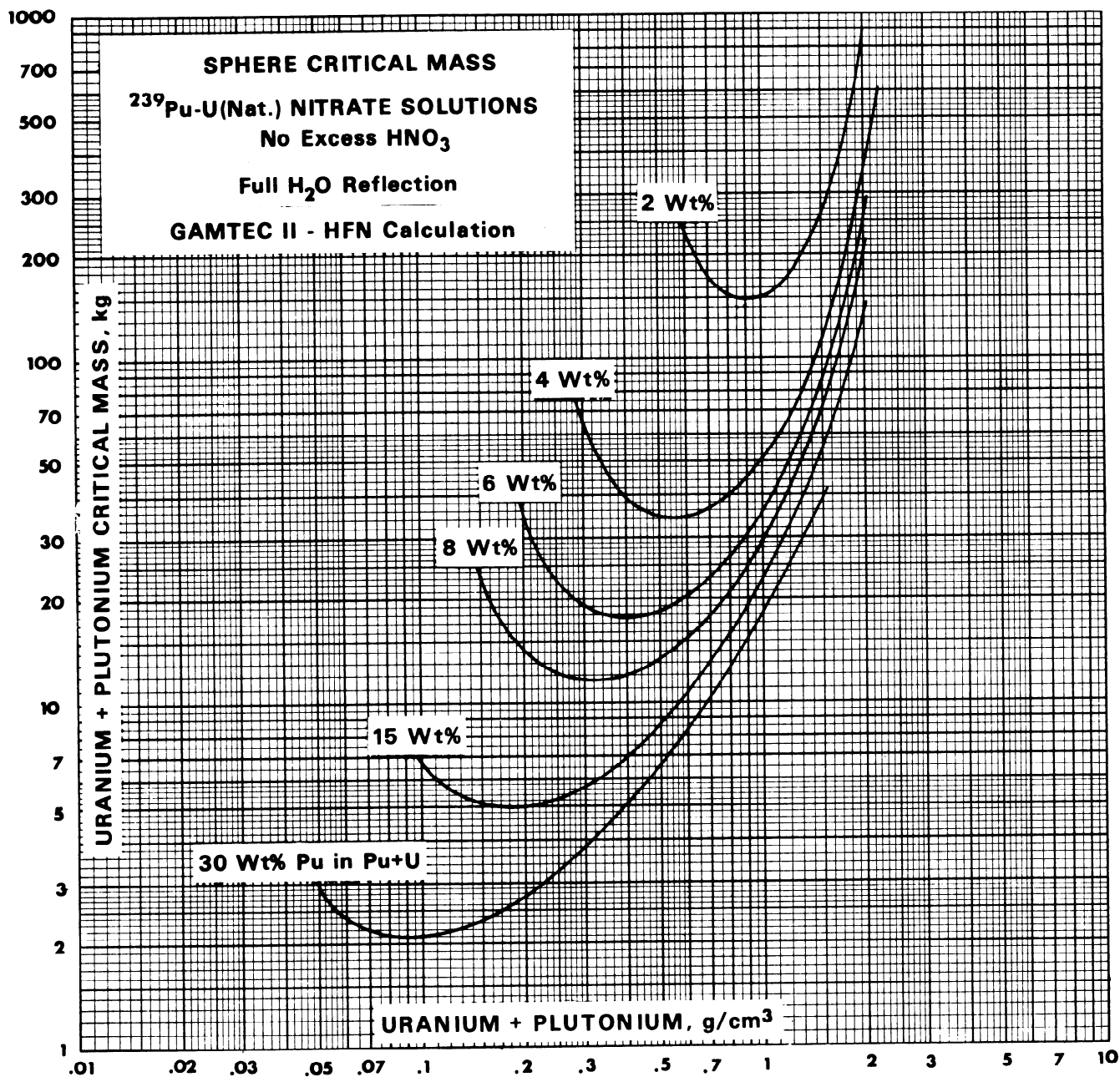

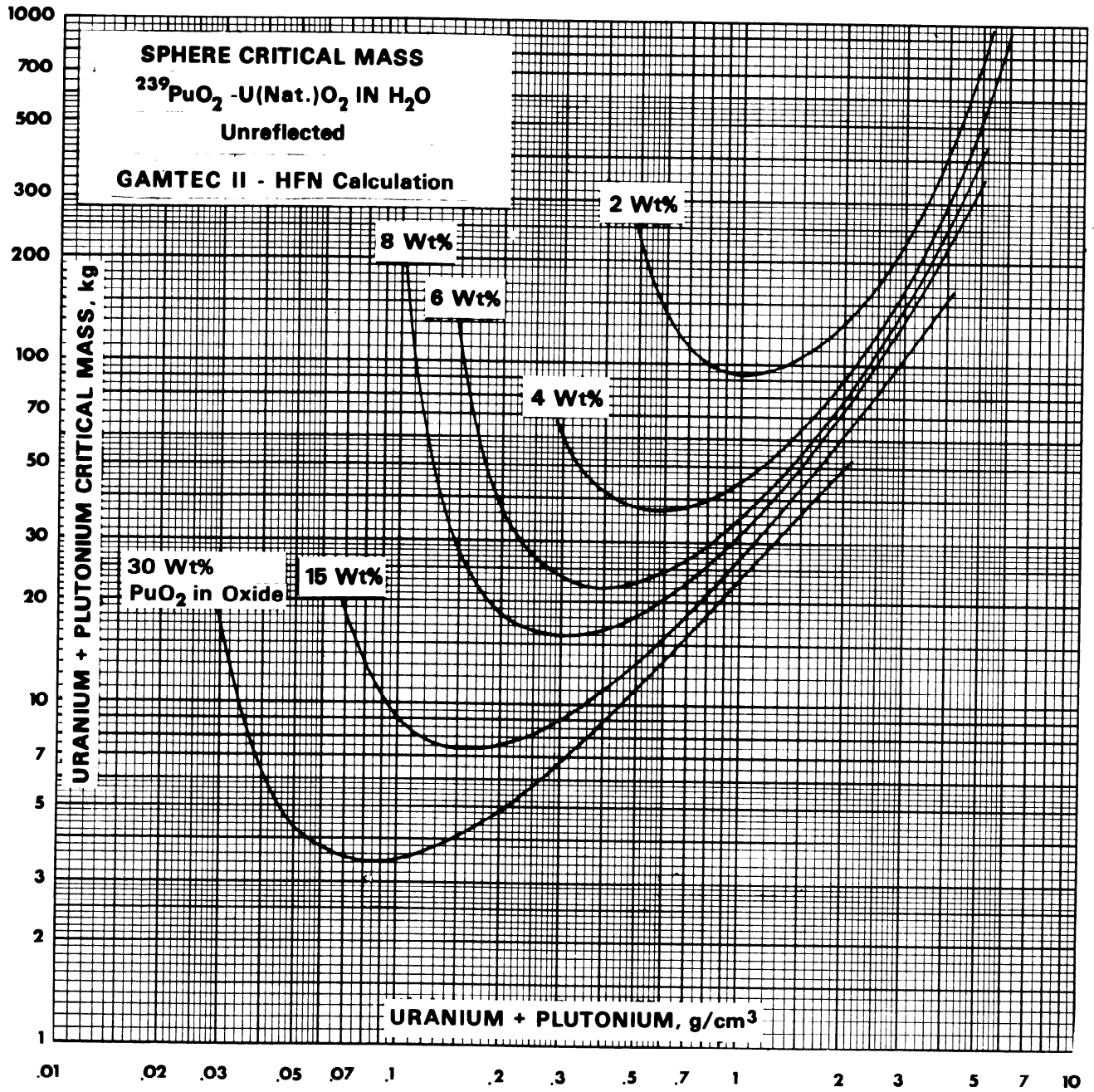

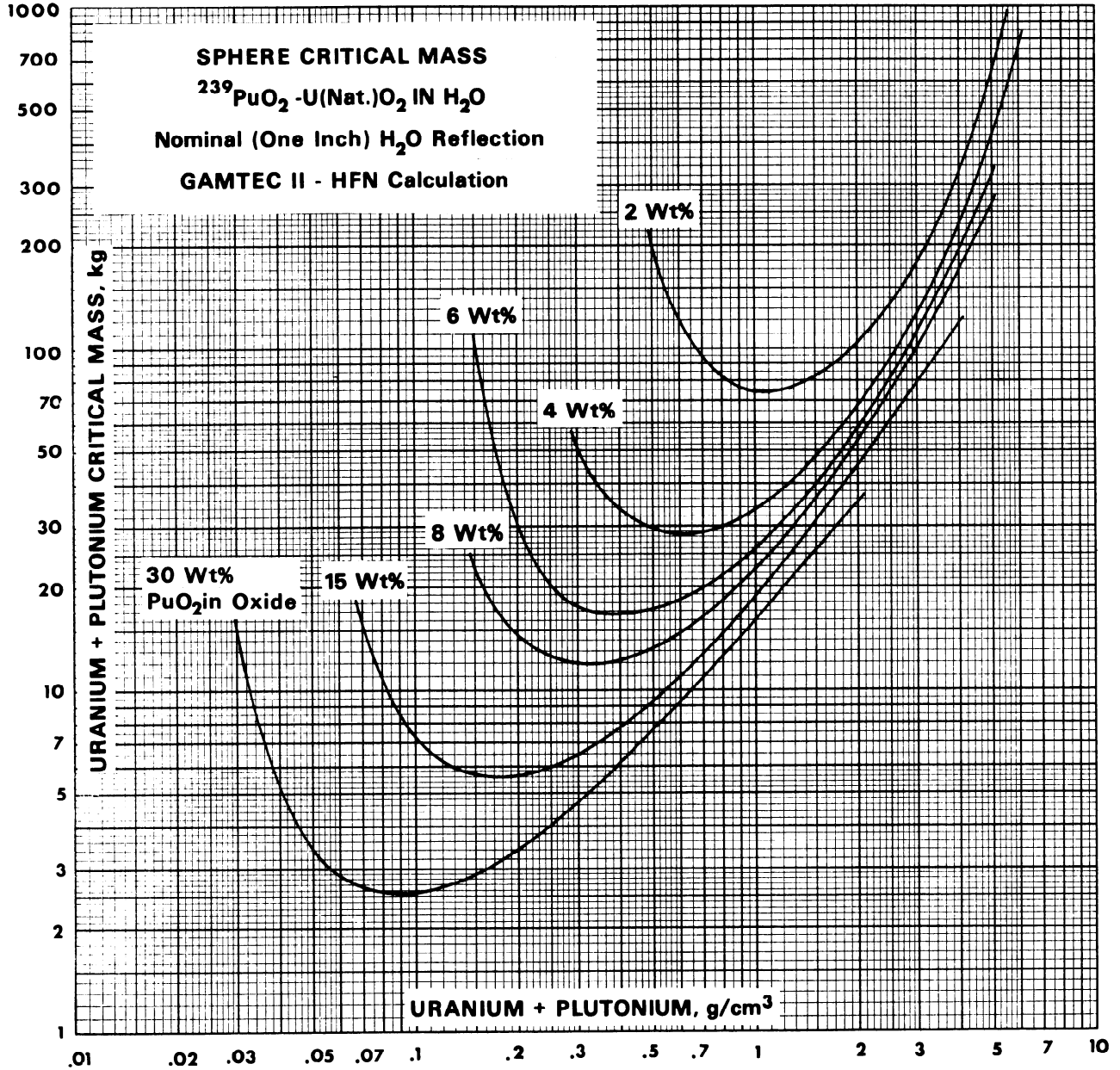

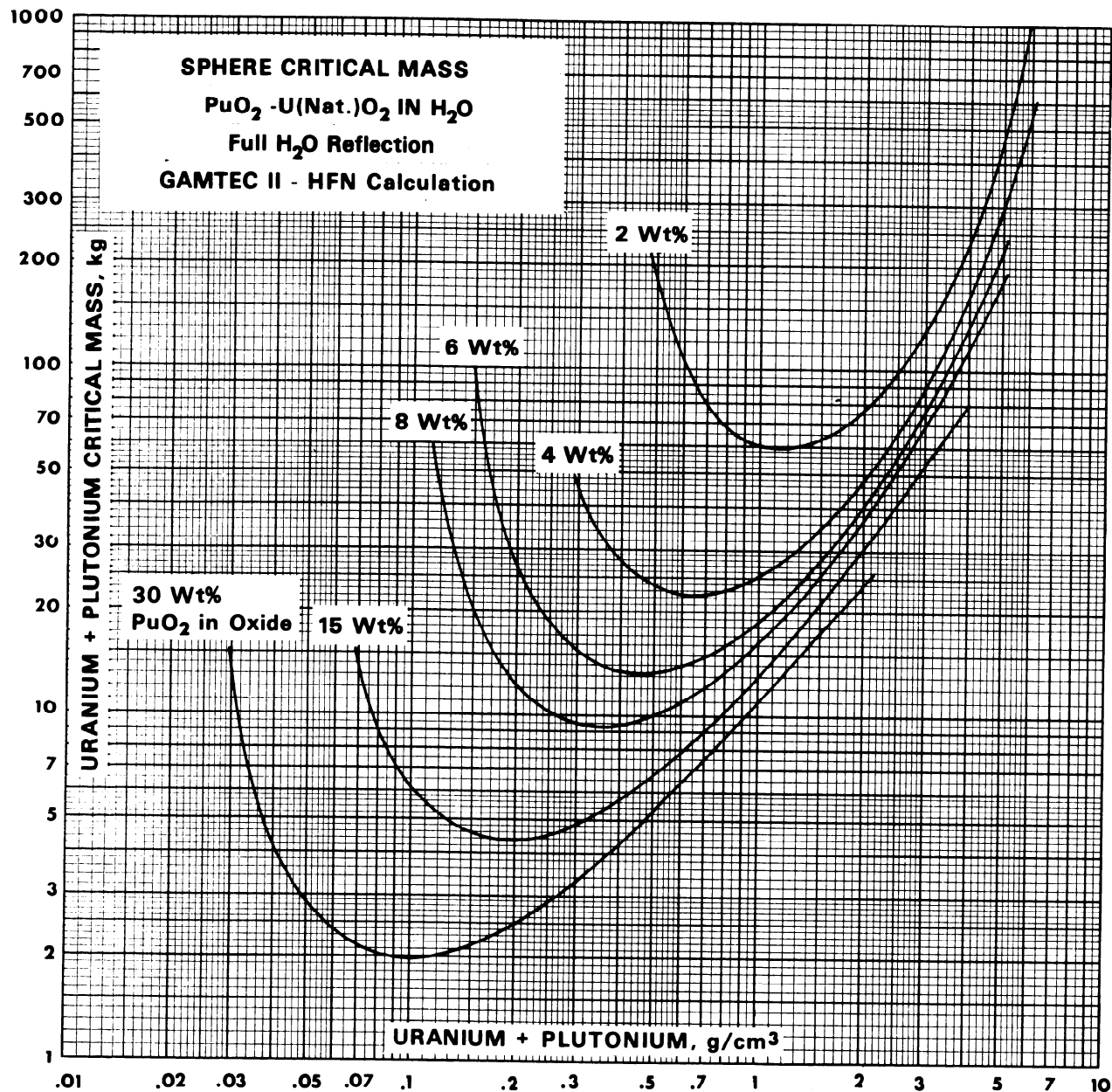

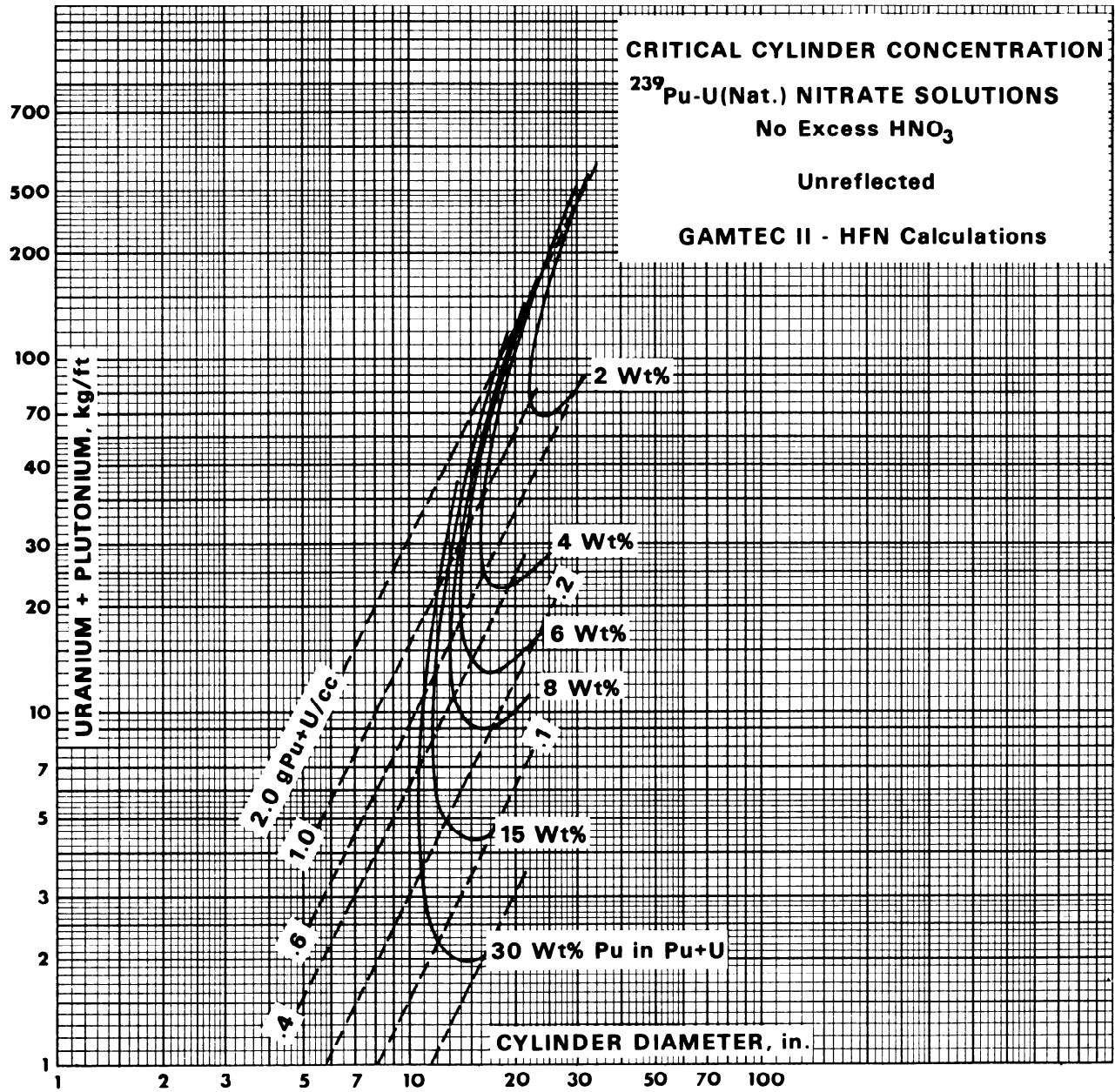

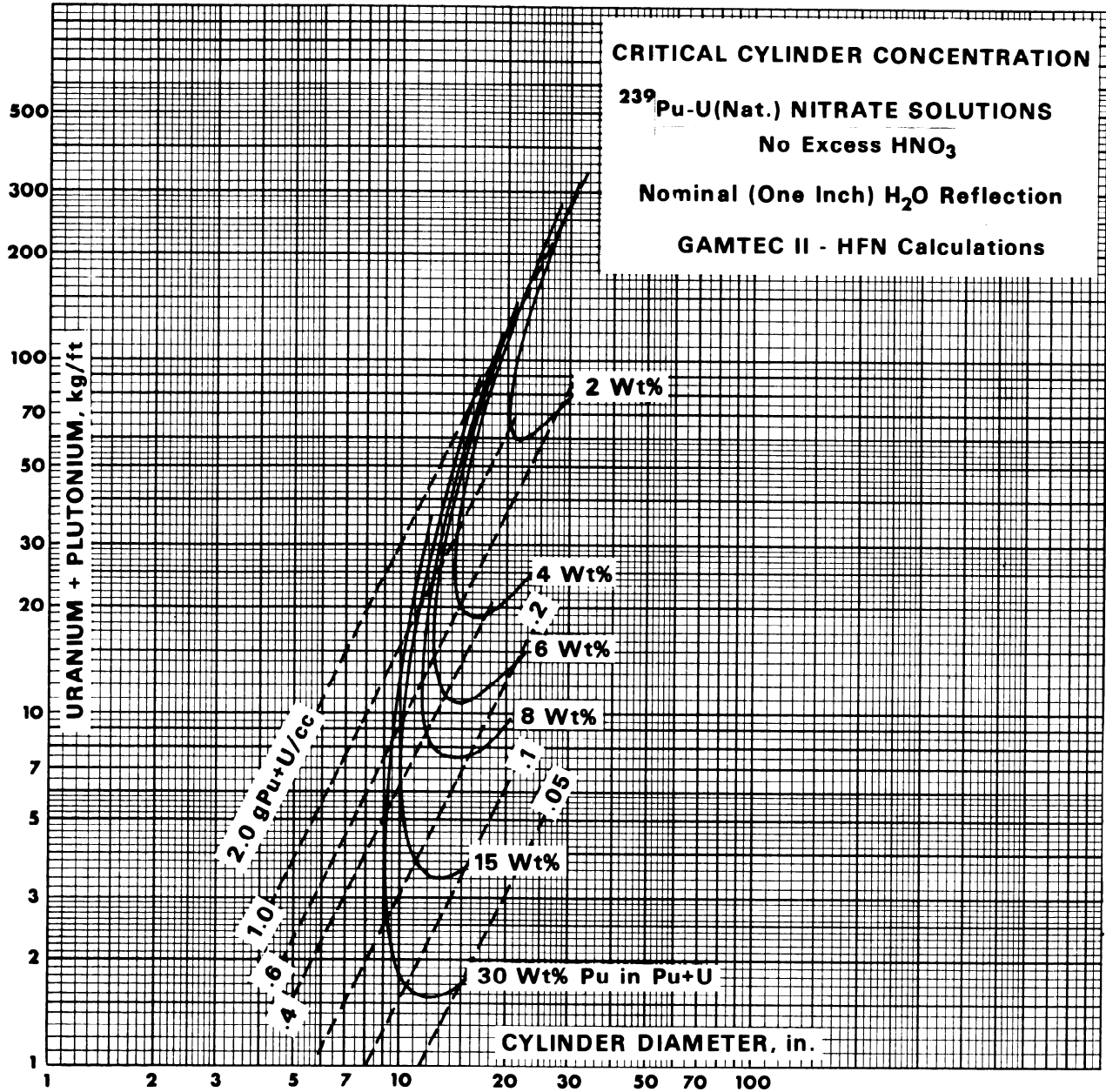

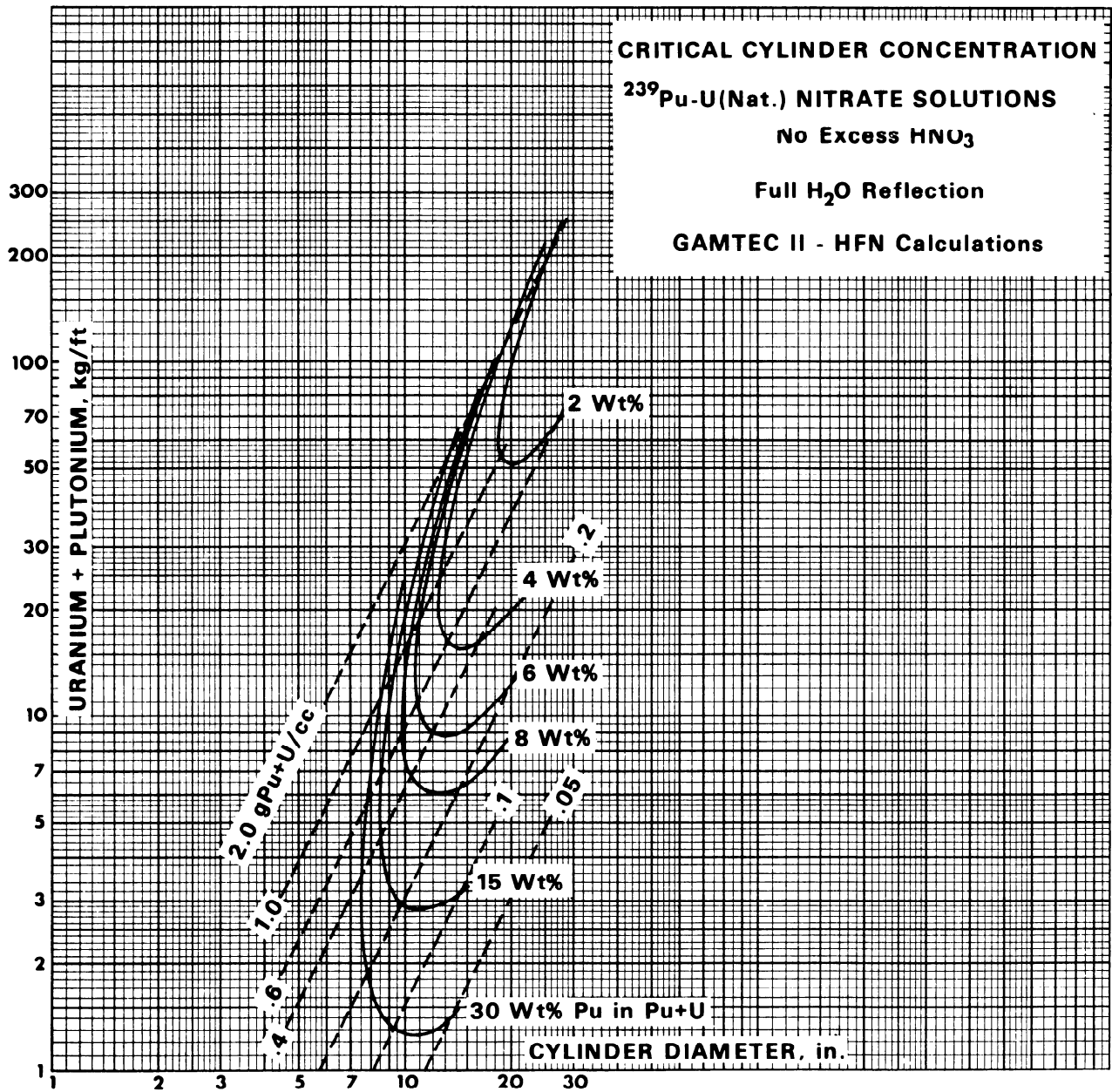

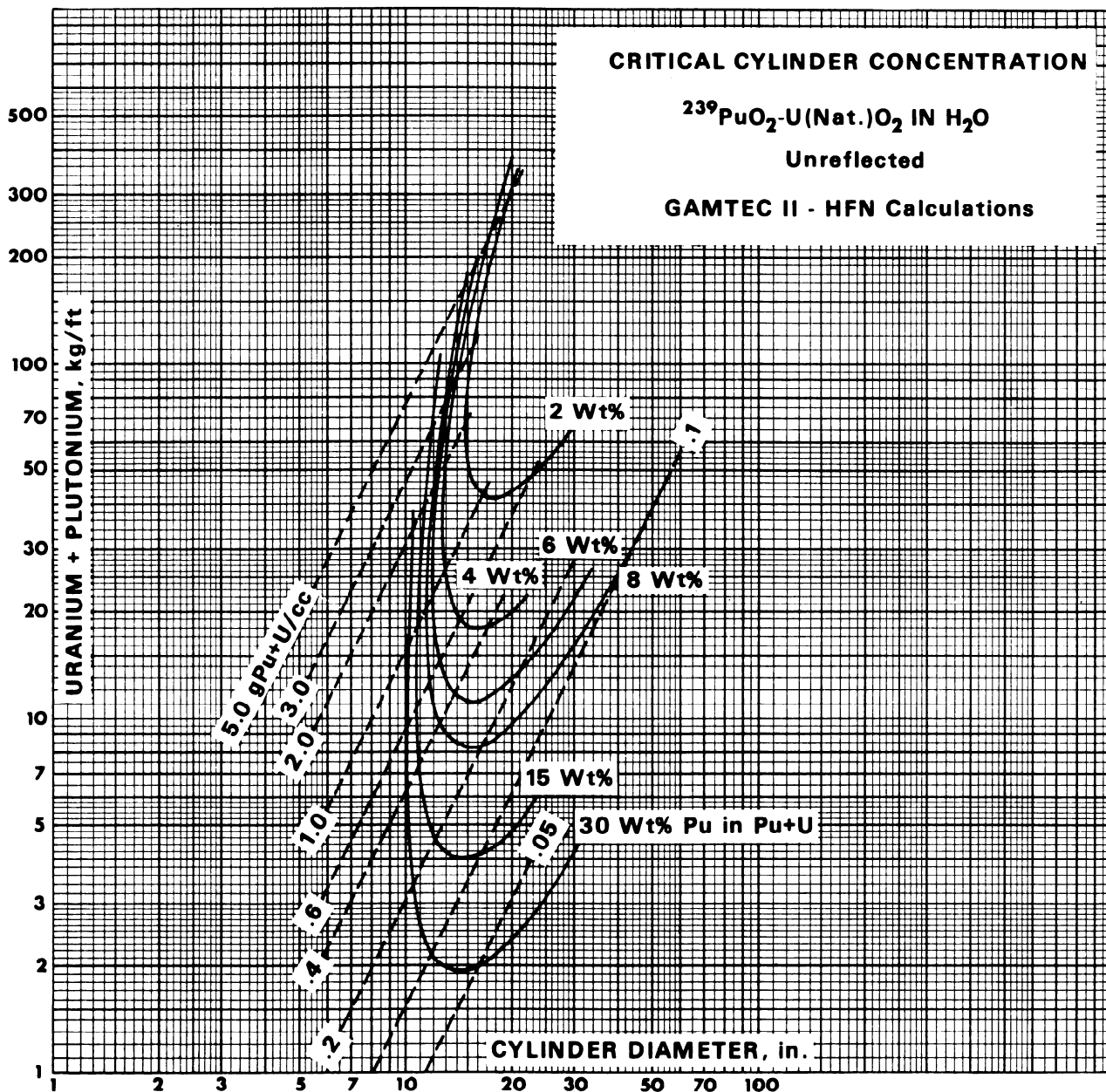

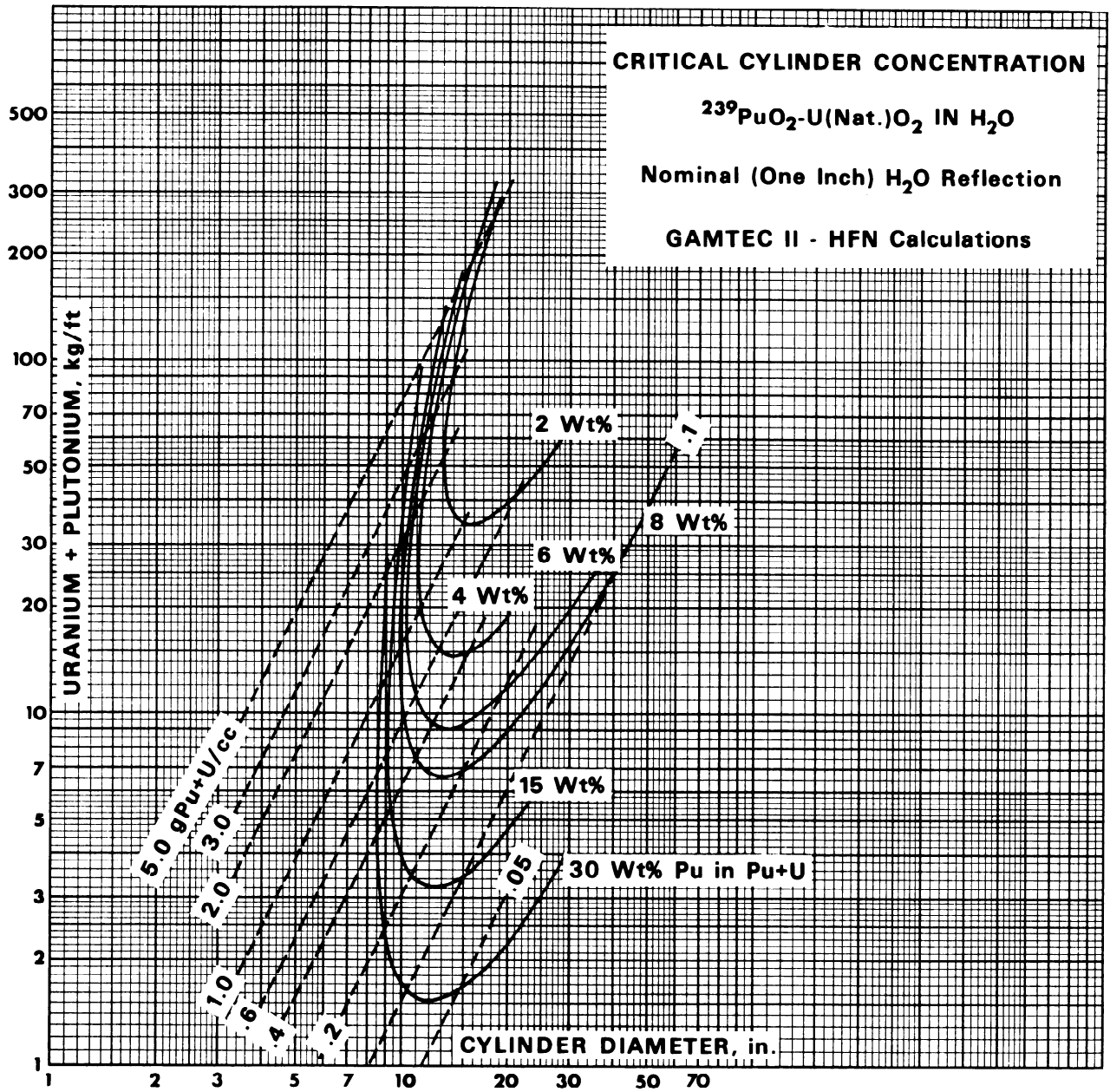

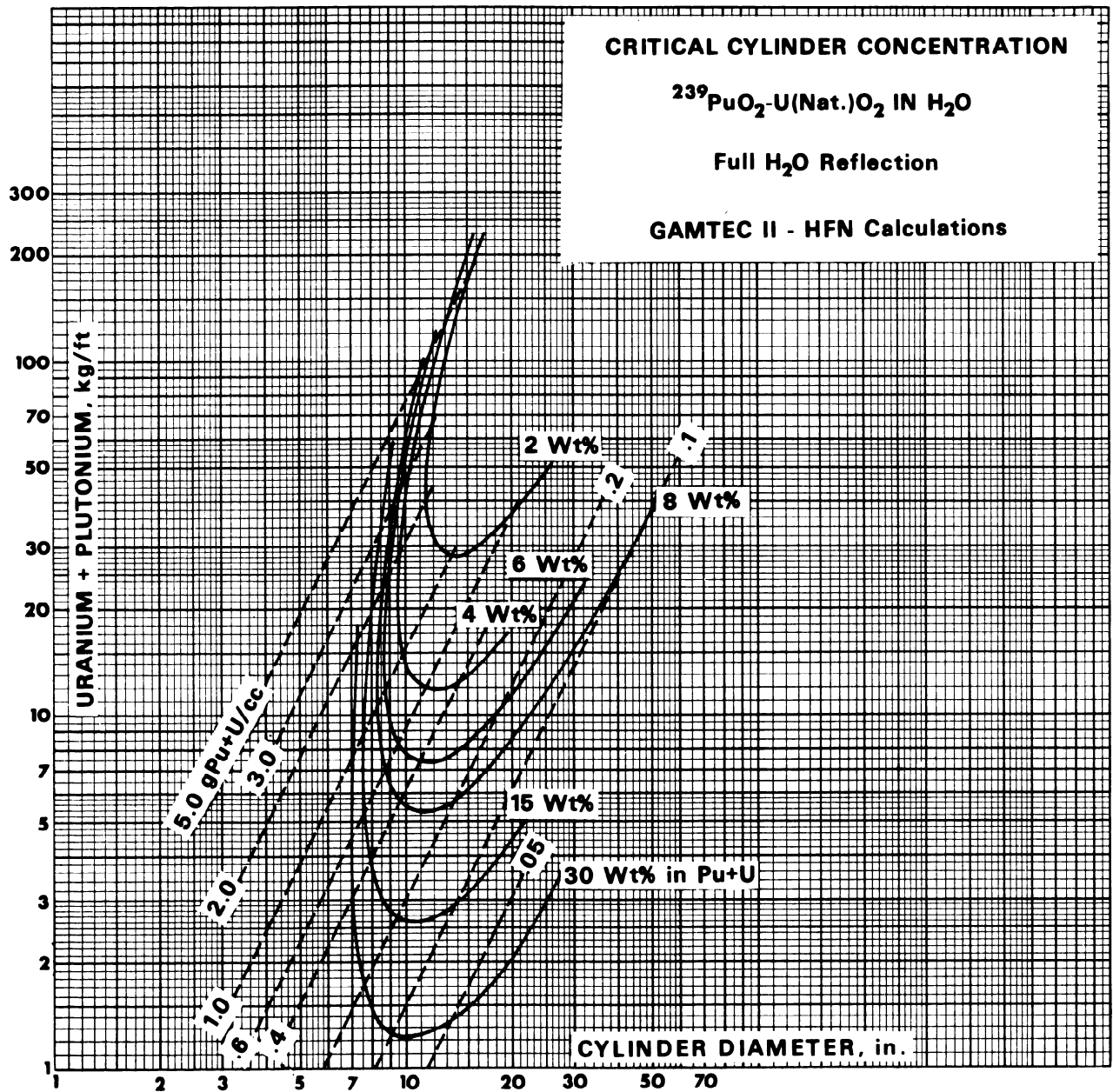

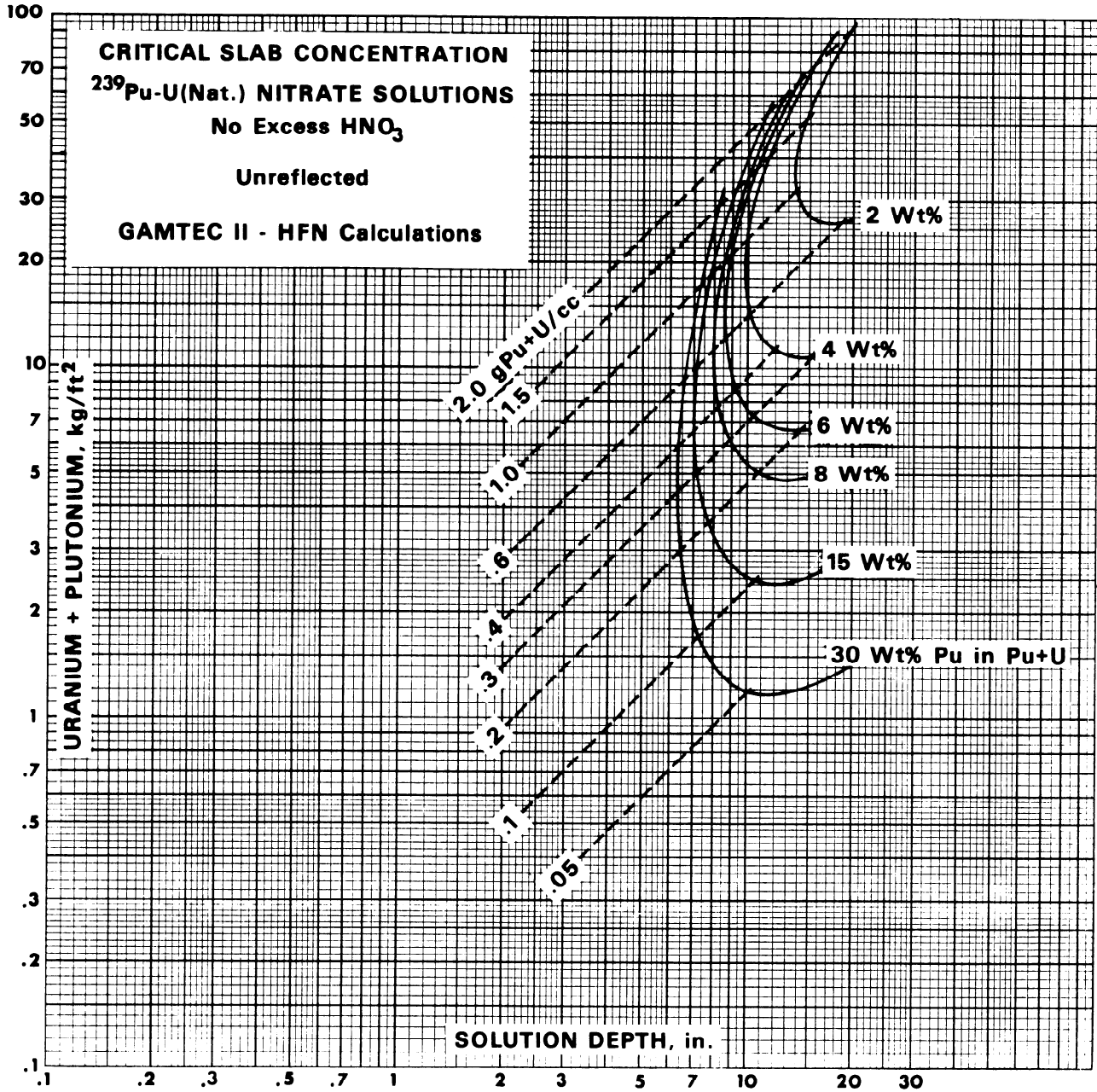

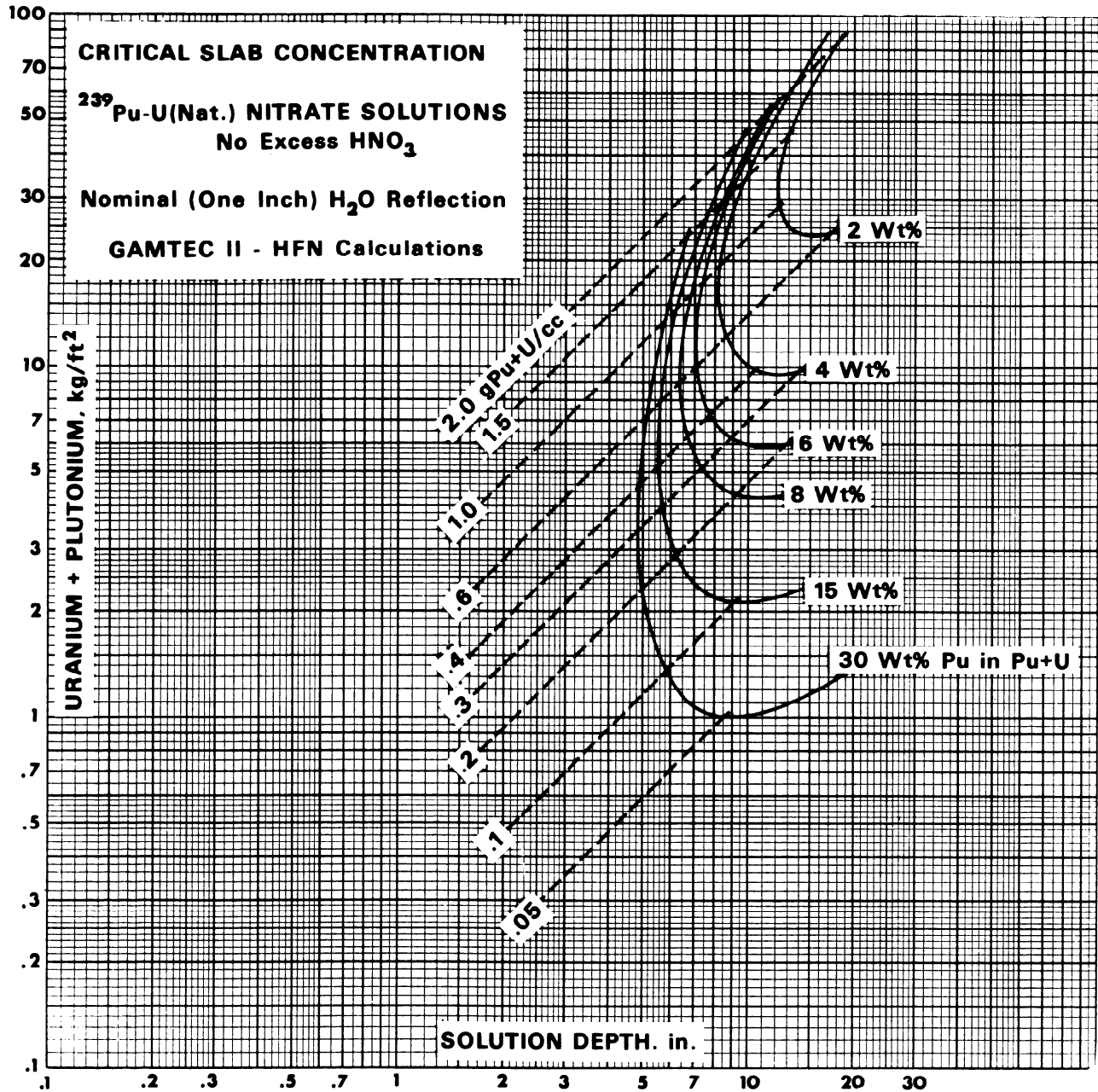

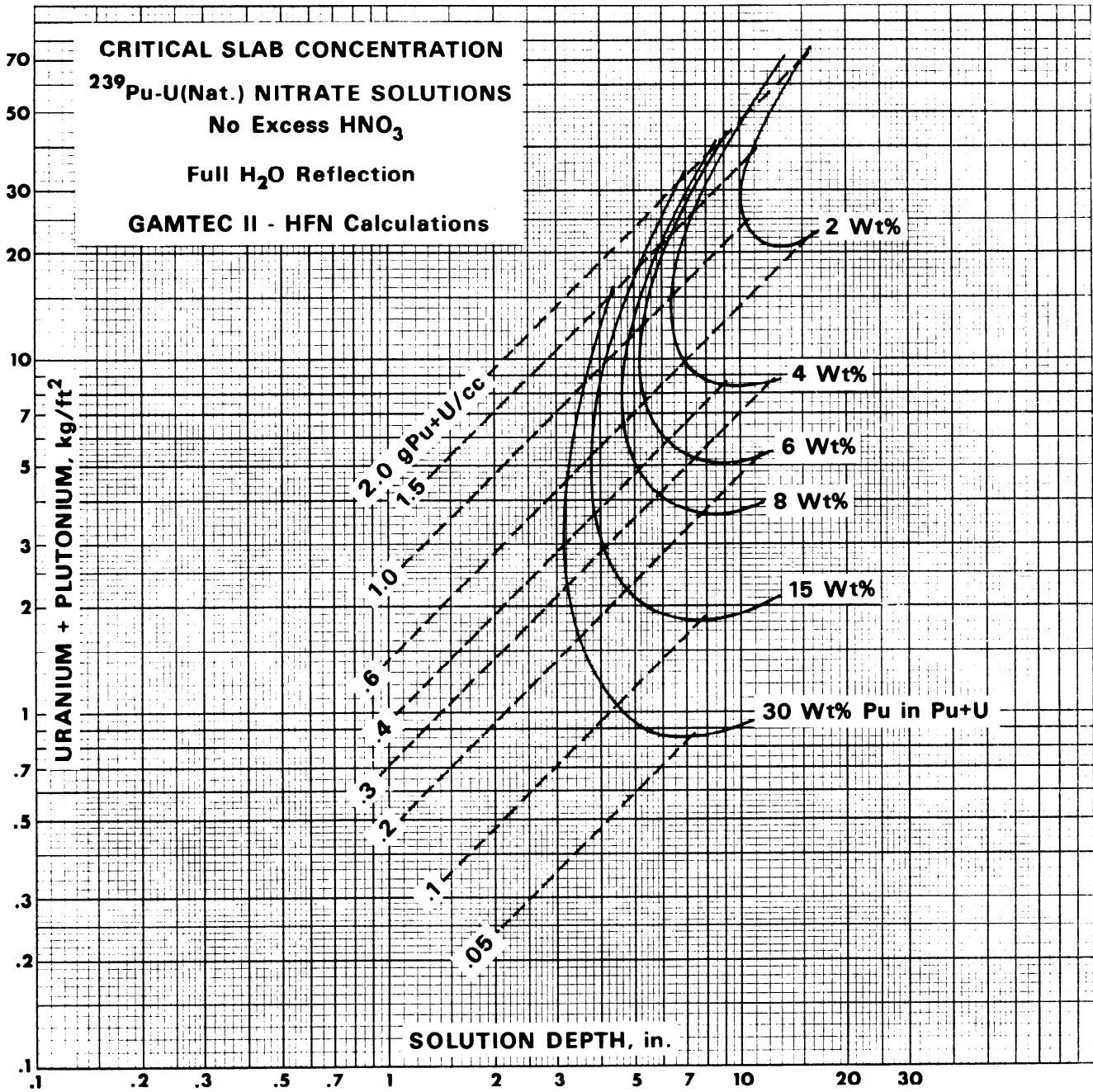

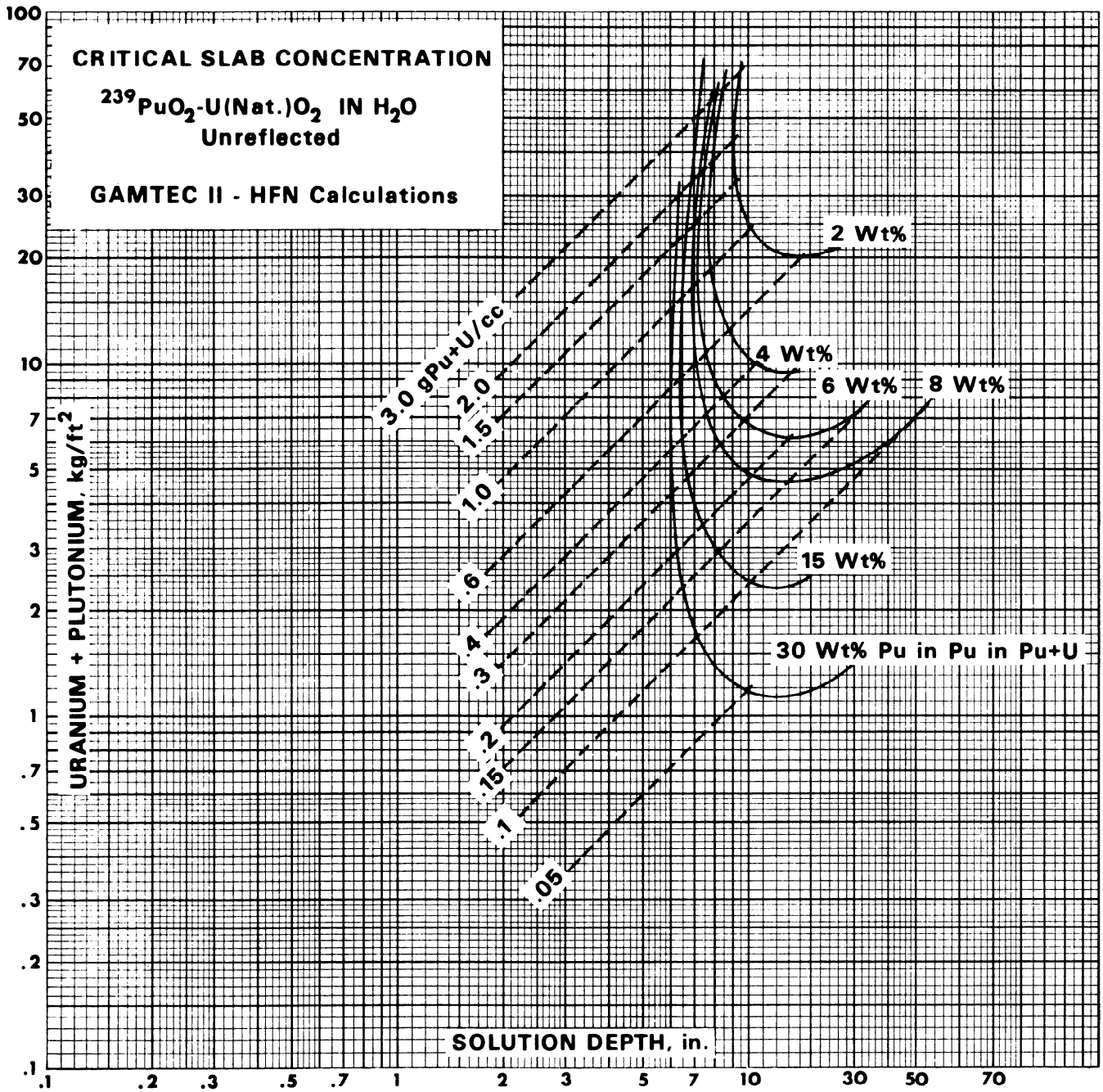

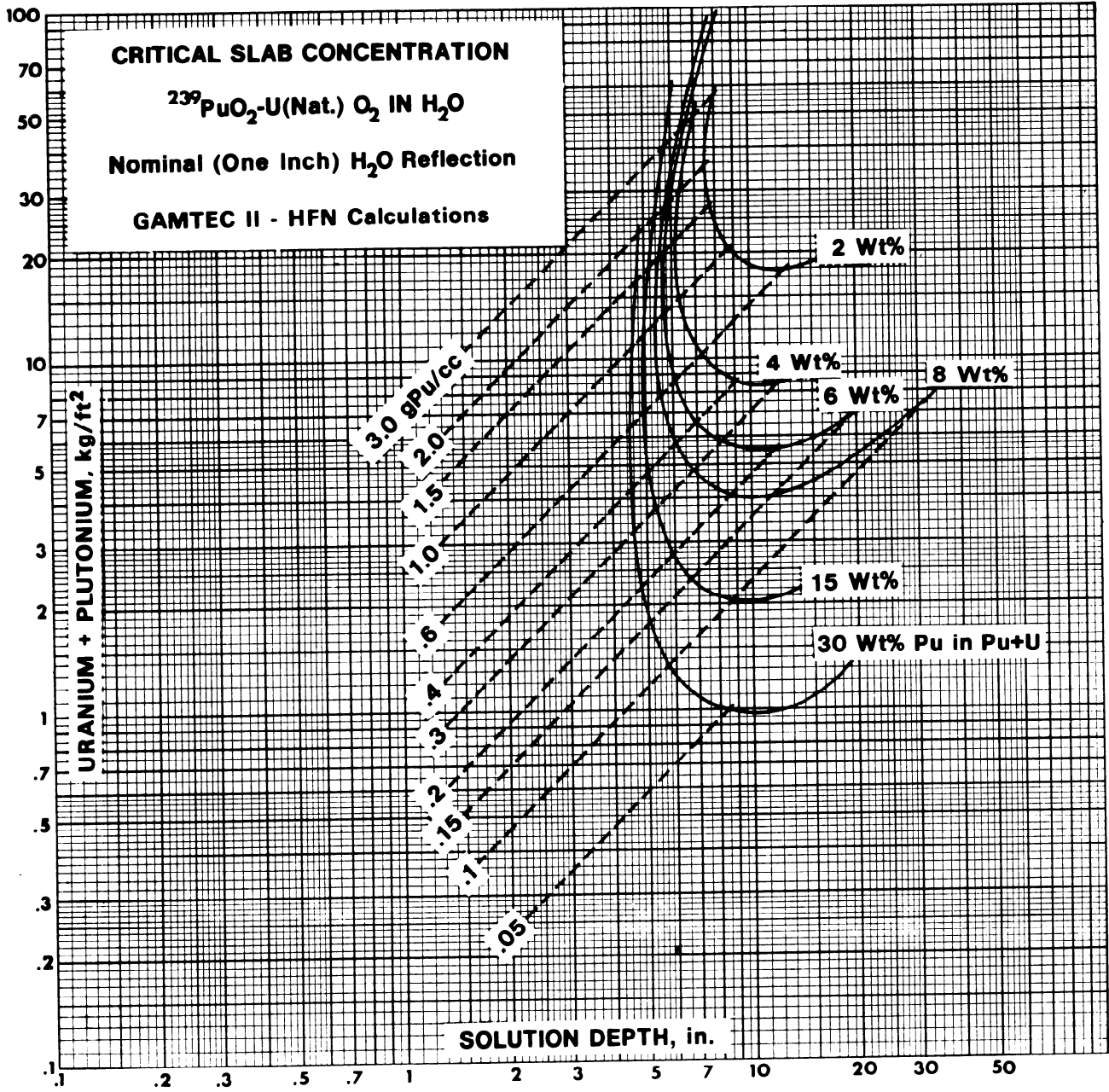

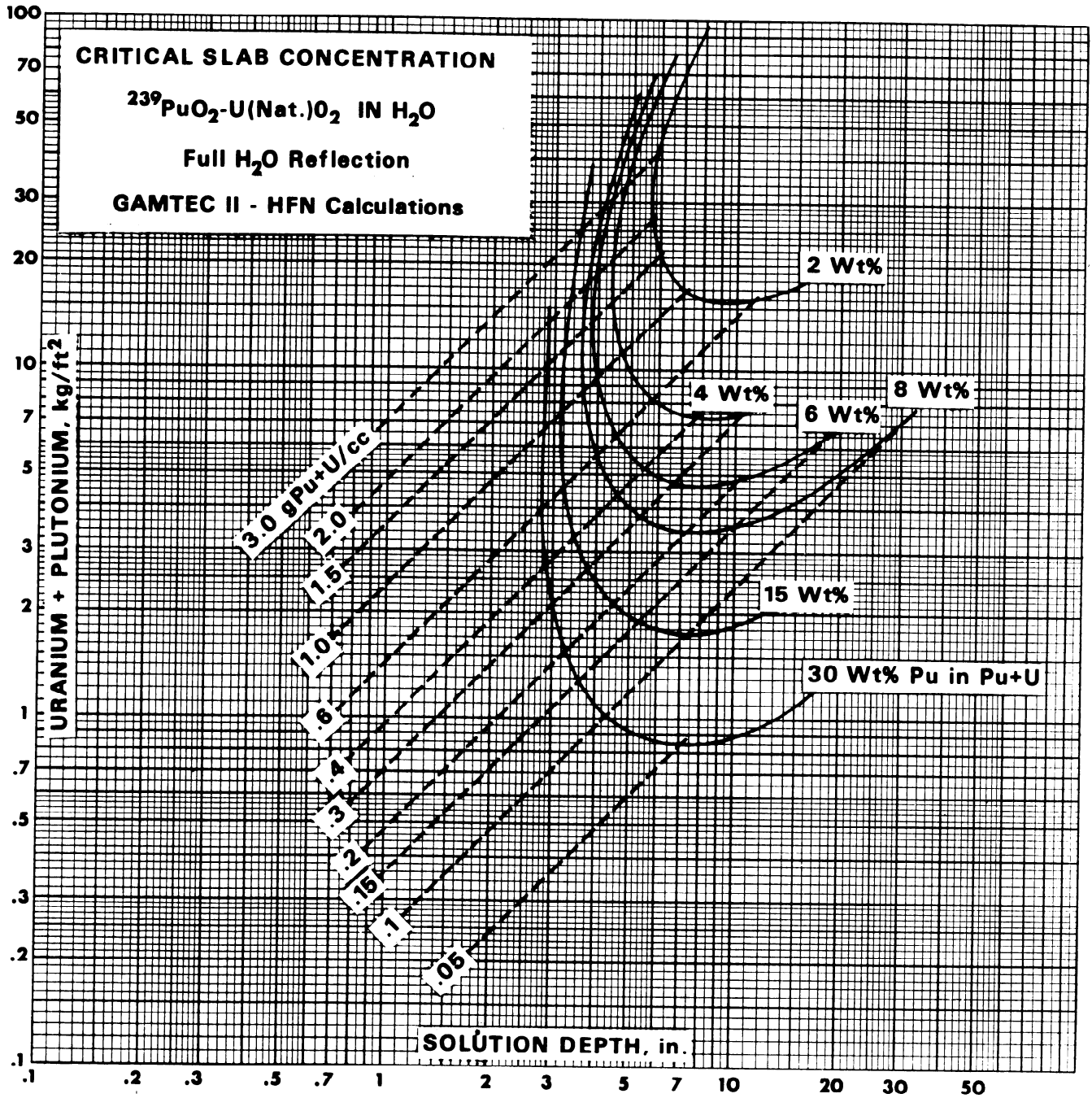

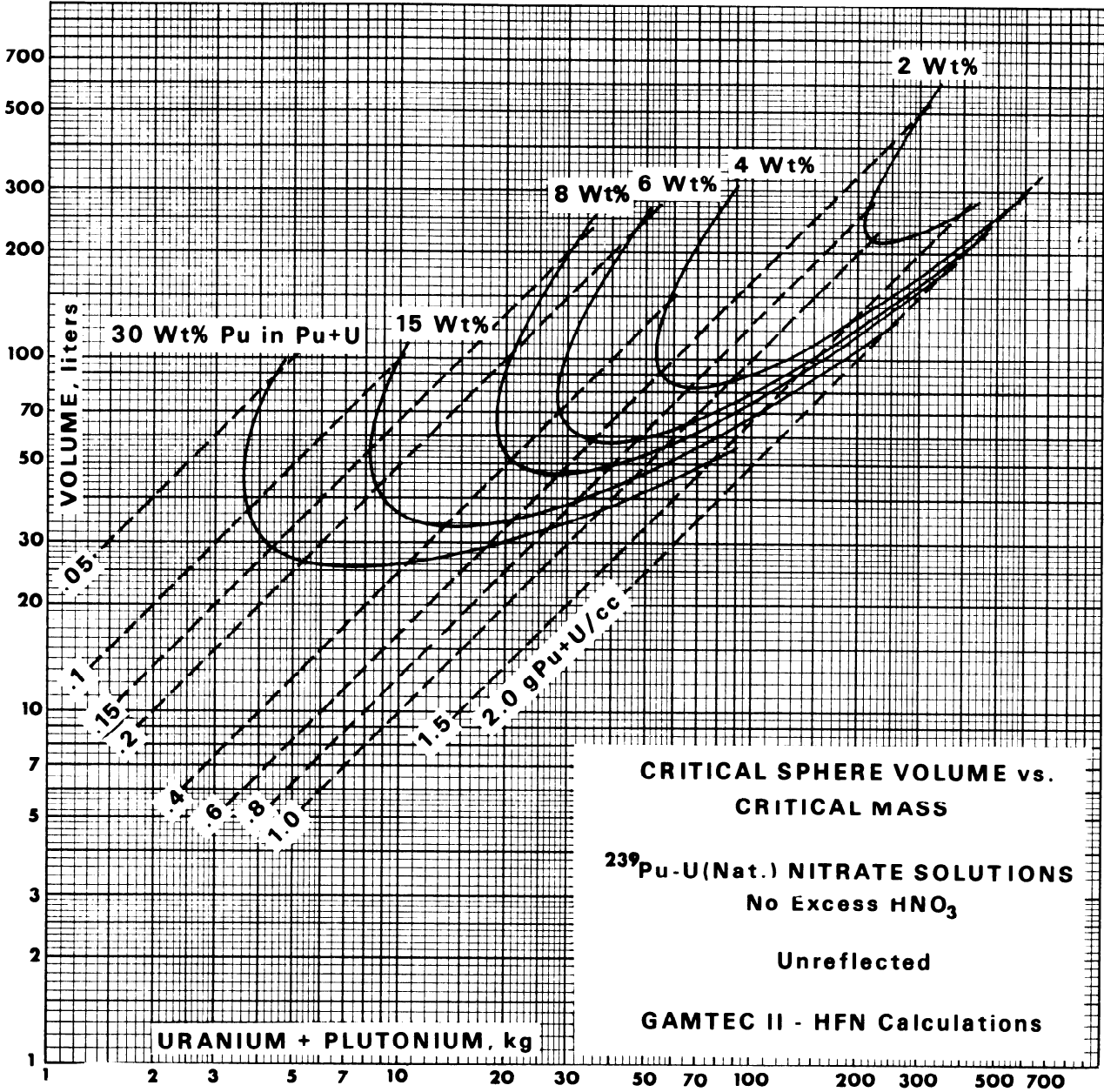

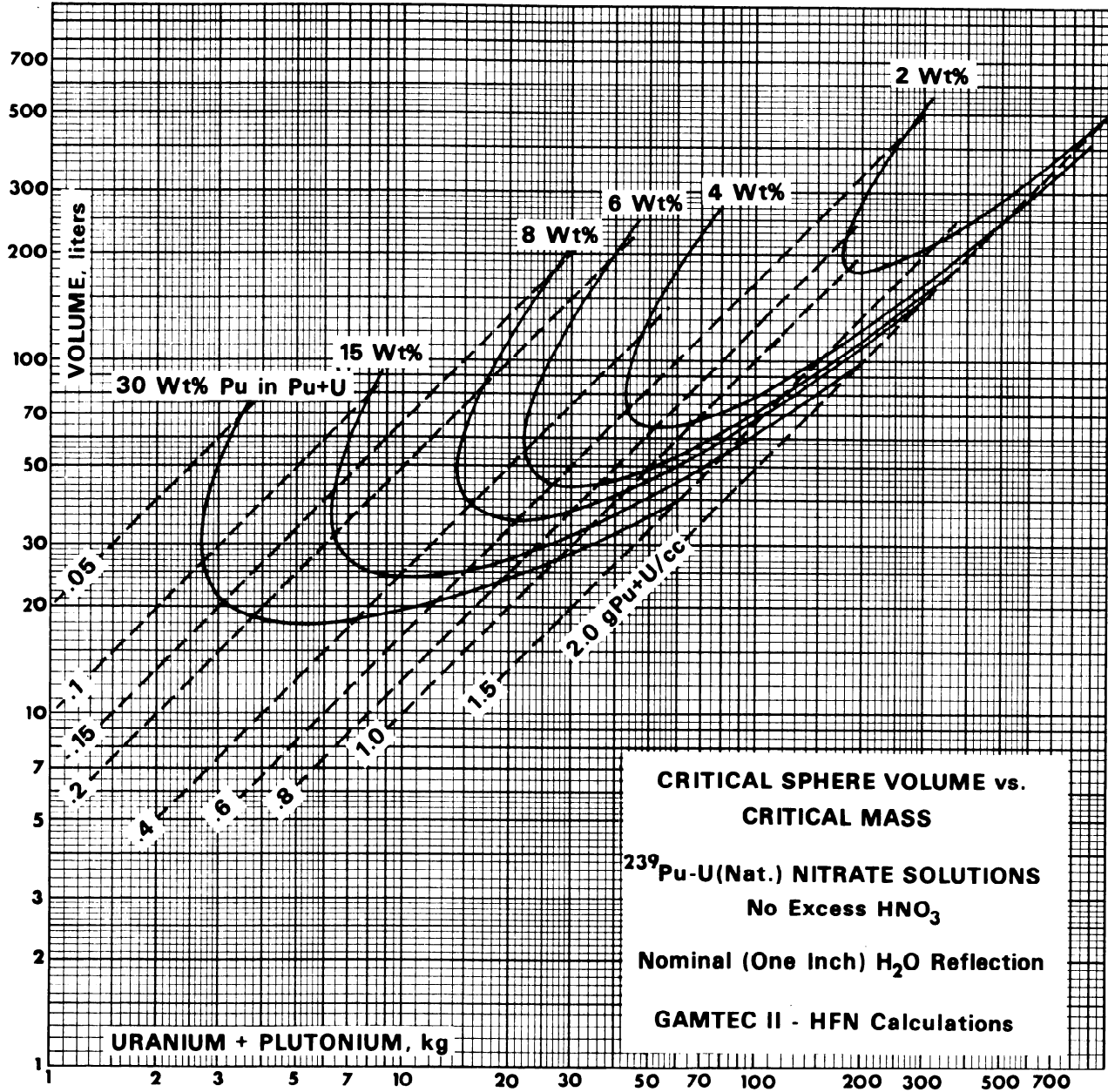

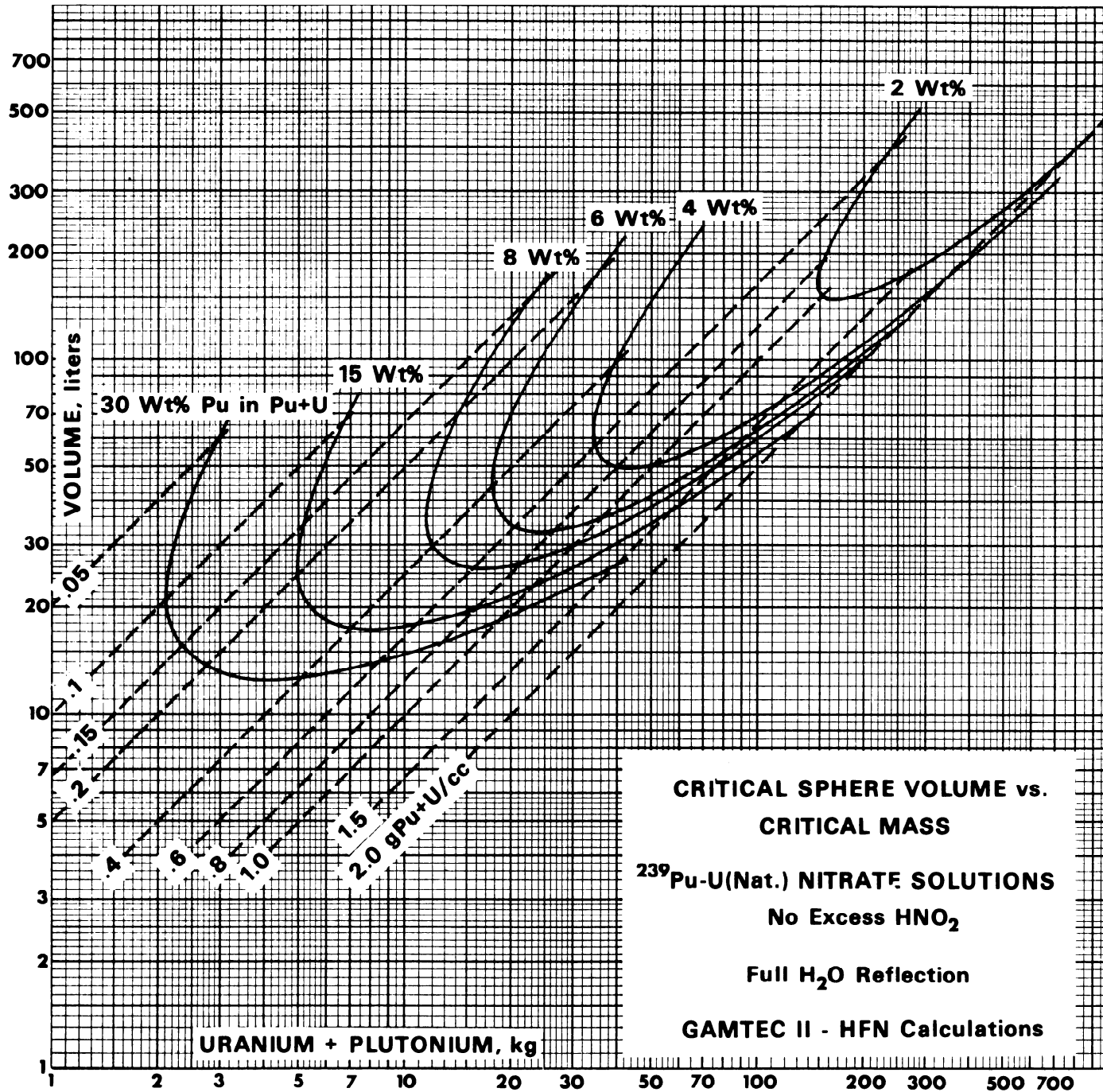

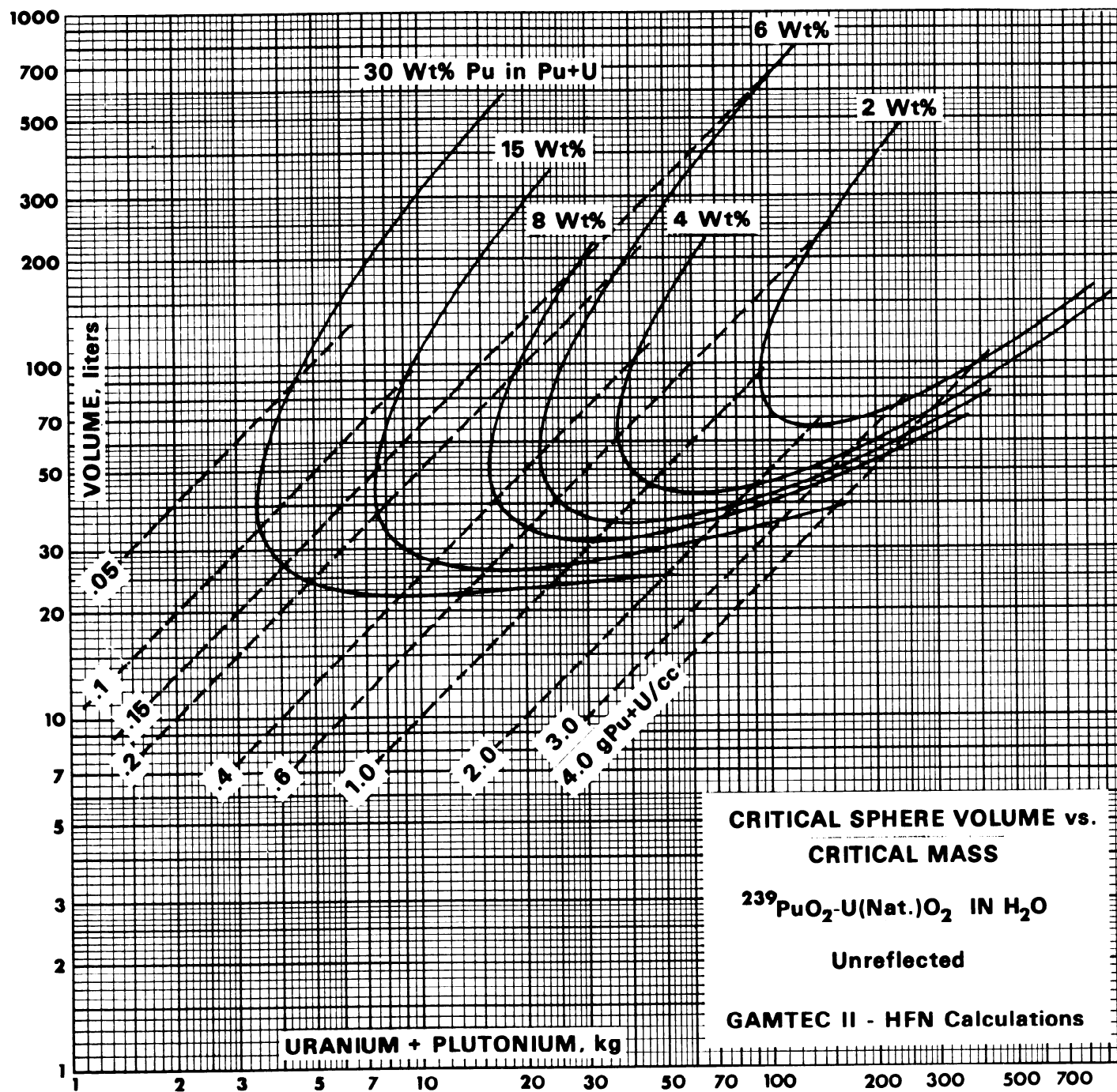

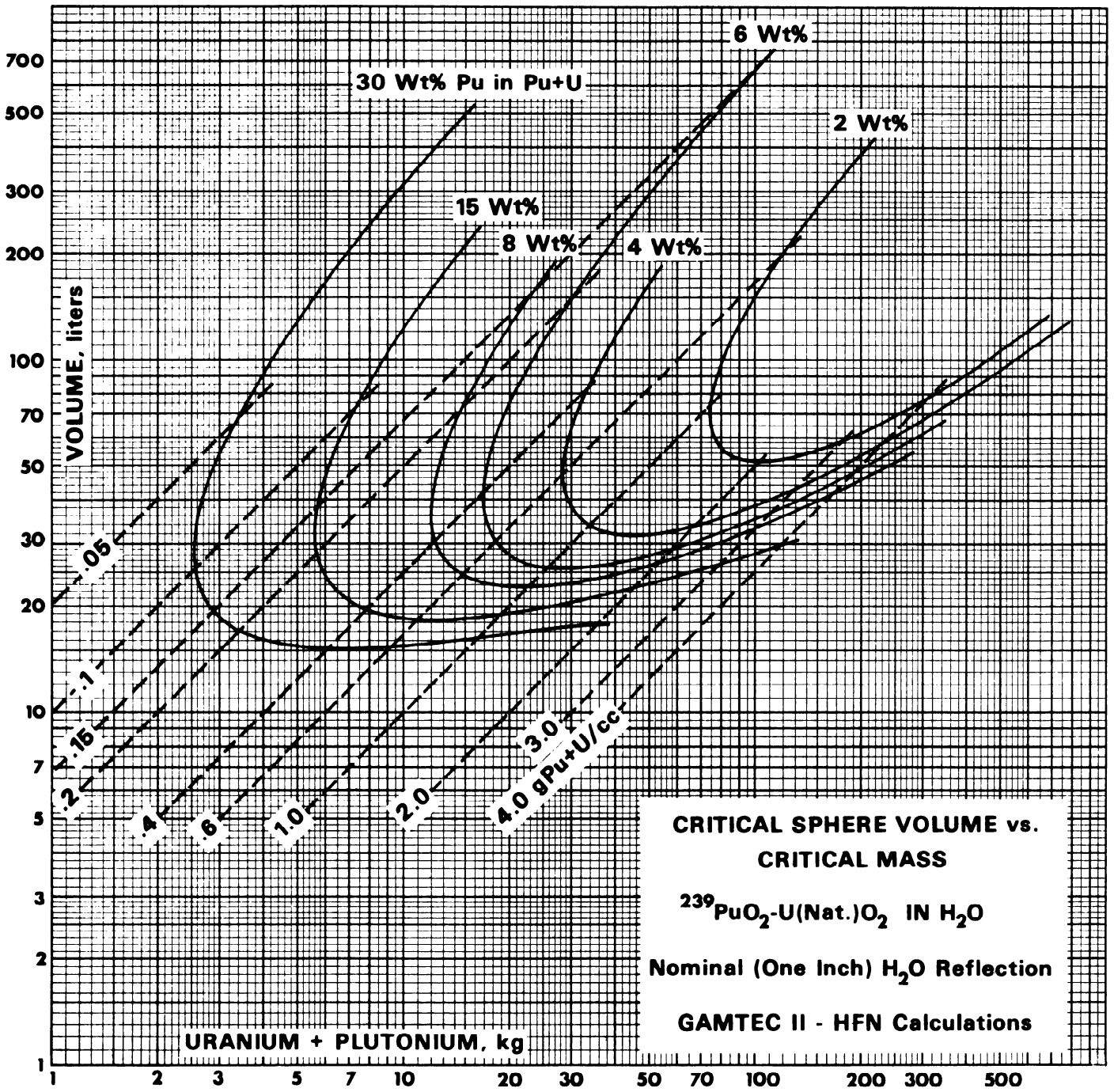

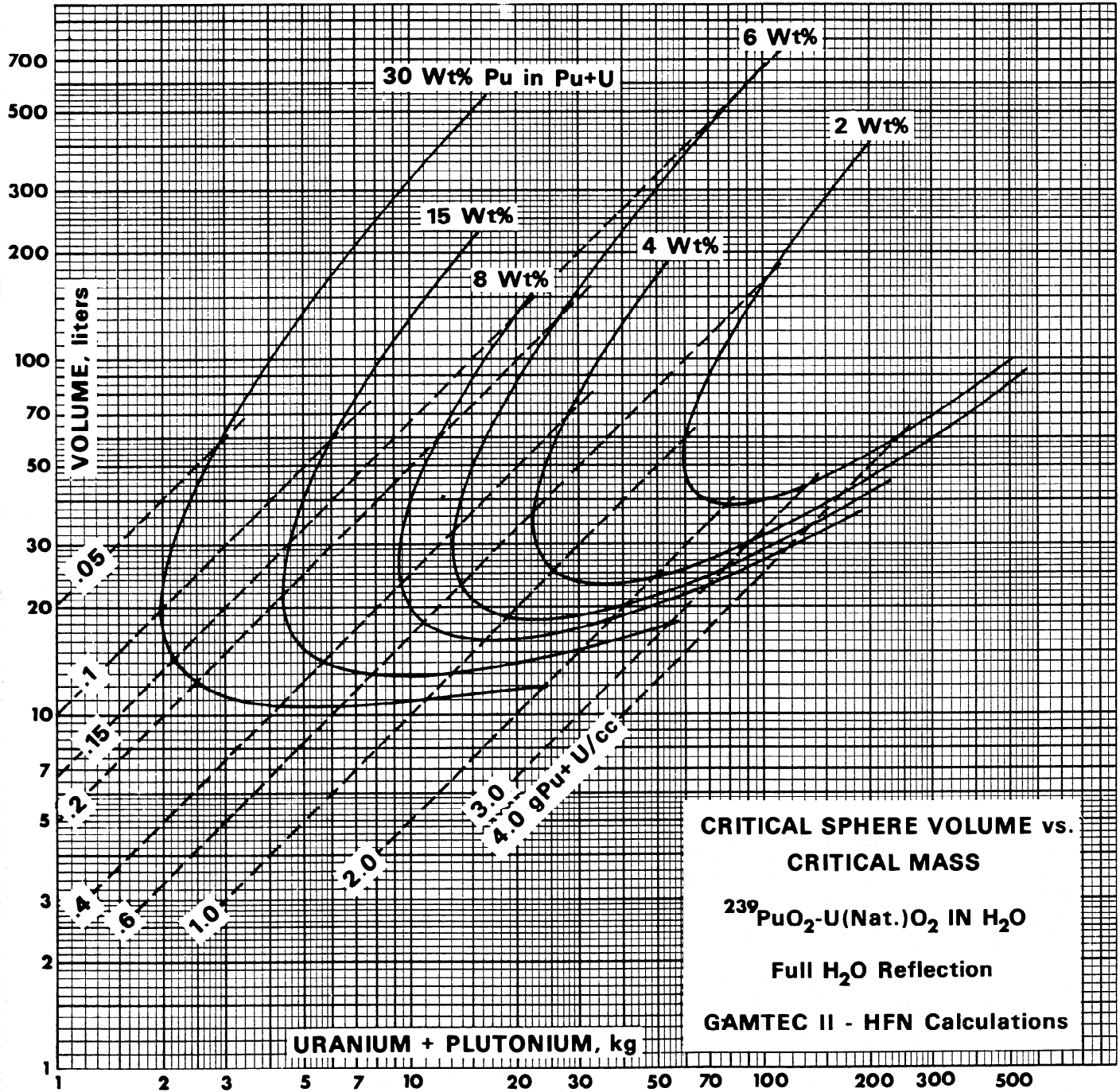

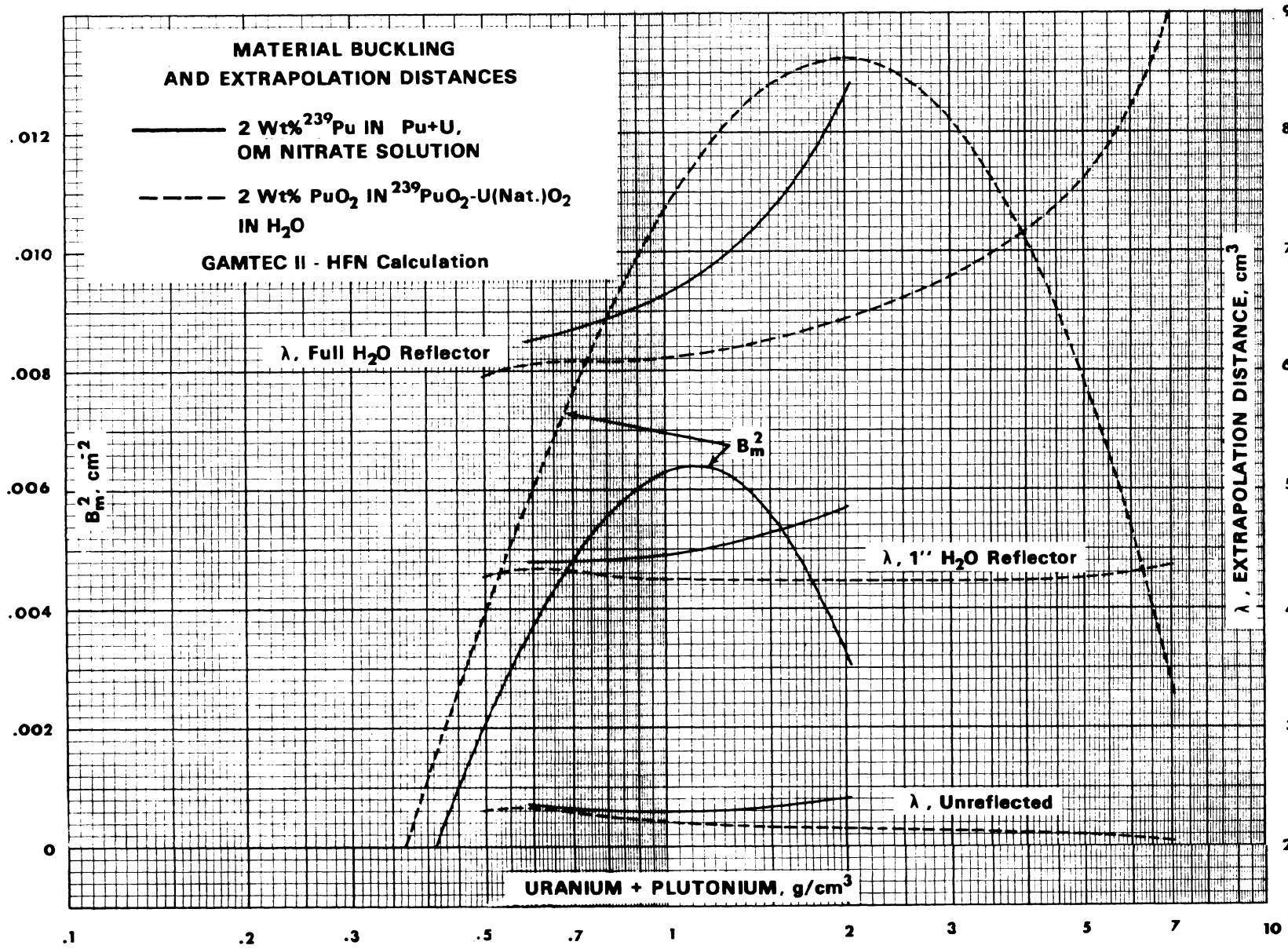

III.D.10(2)-1

ARRH-600

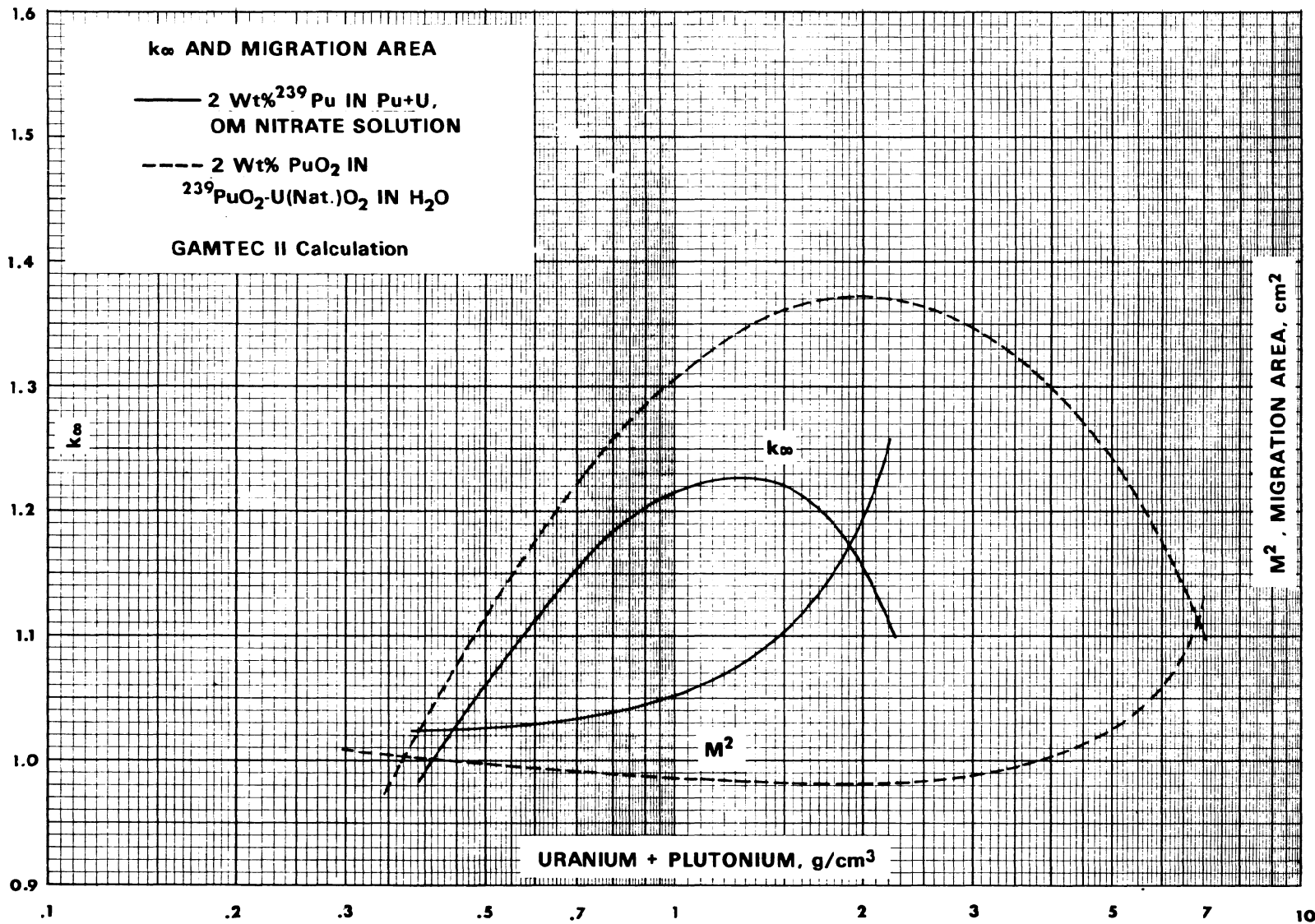

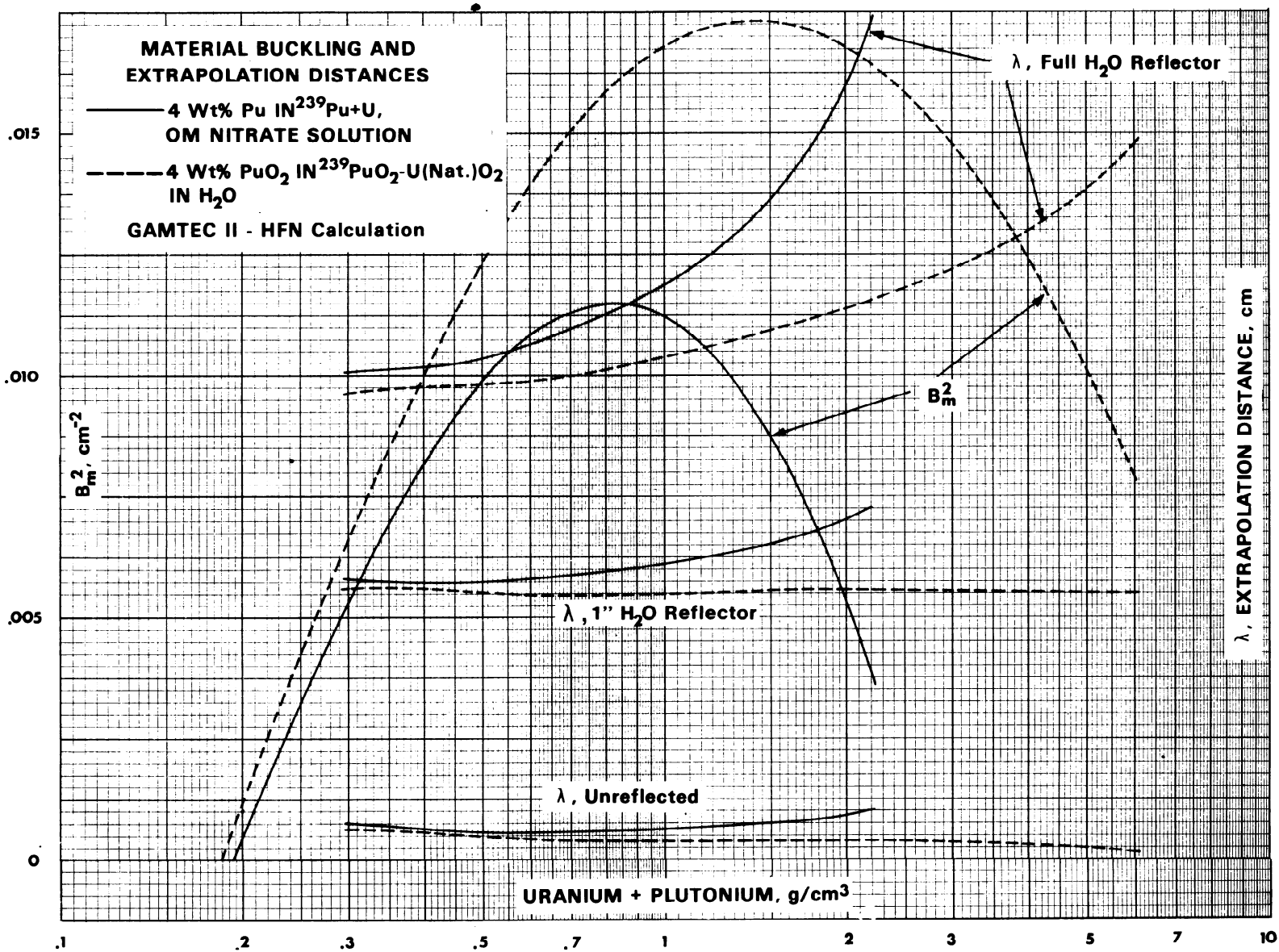

III. D.10(4)-1

ARRH-600

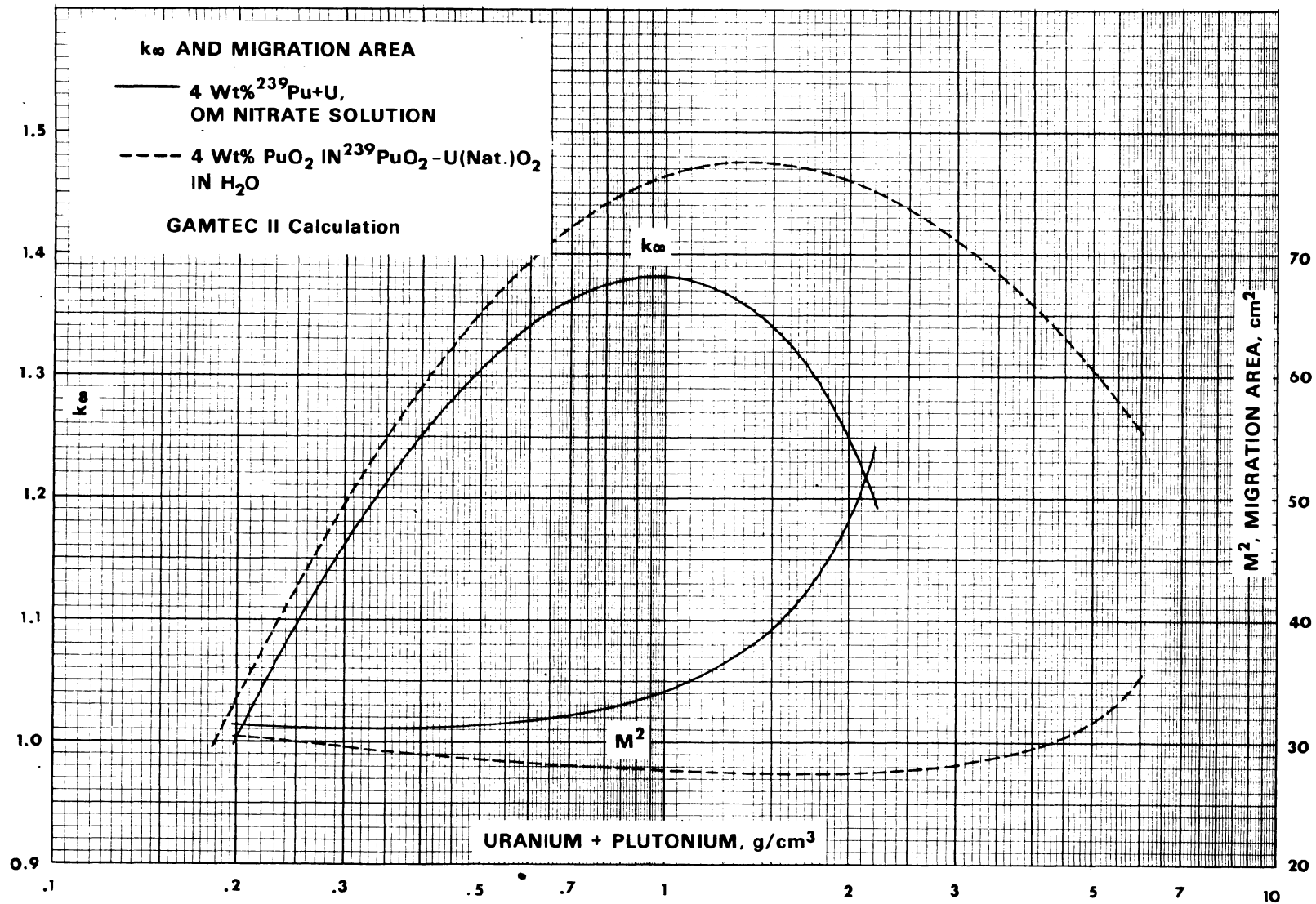

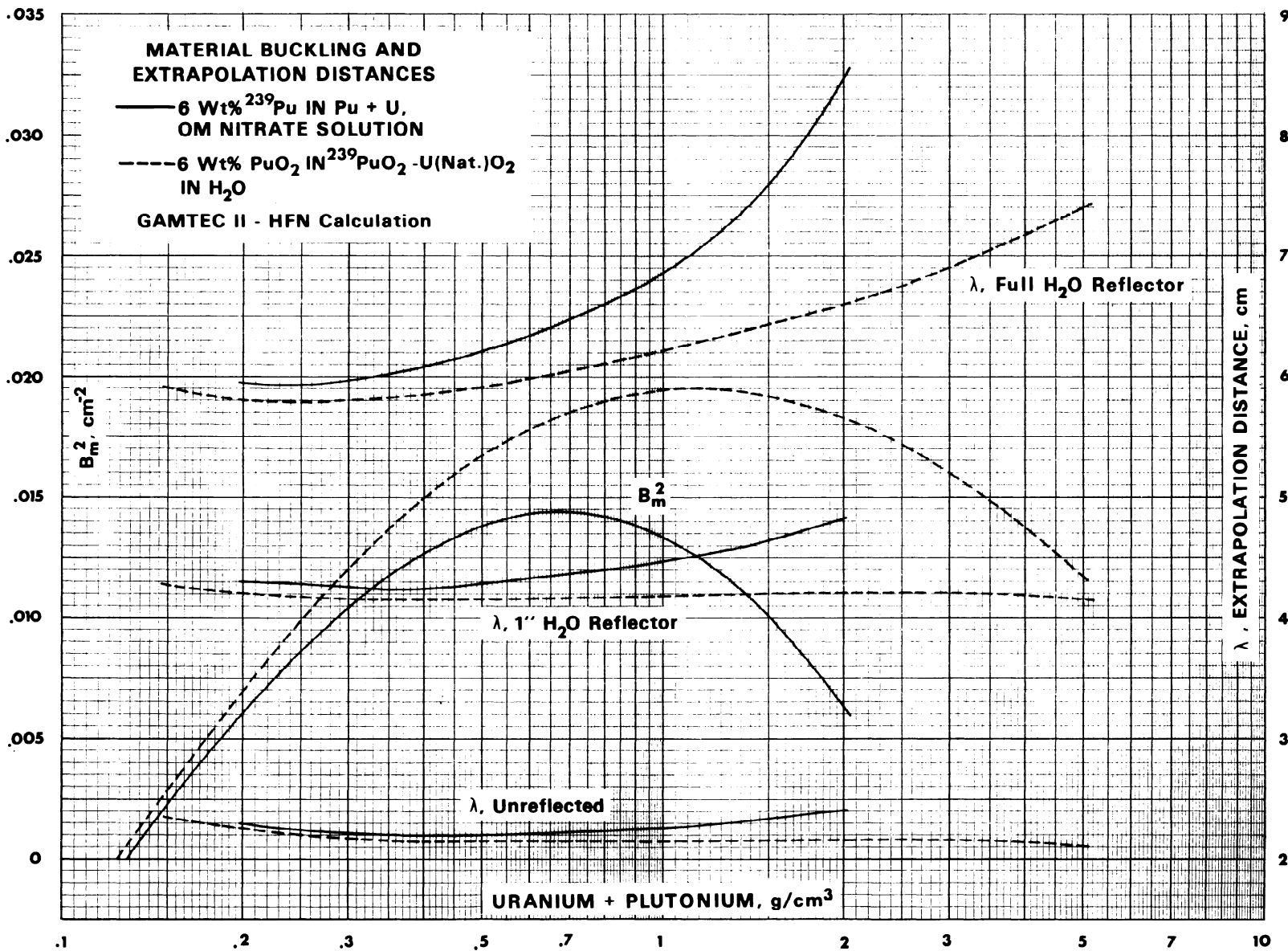

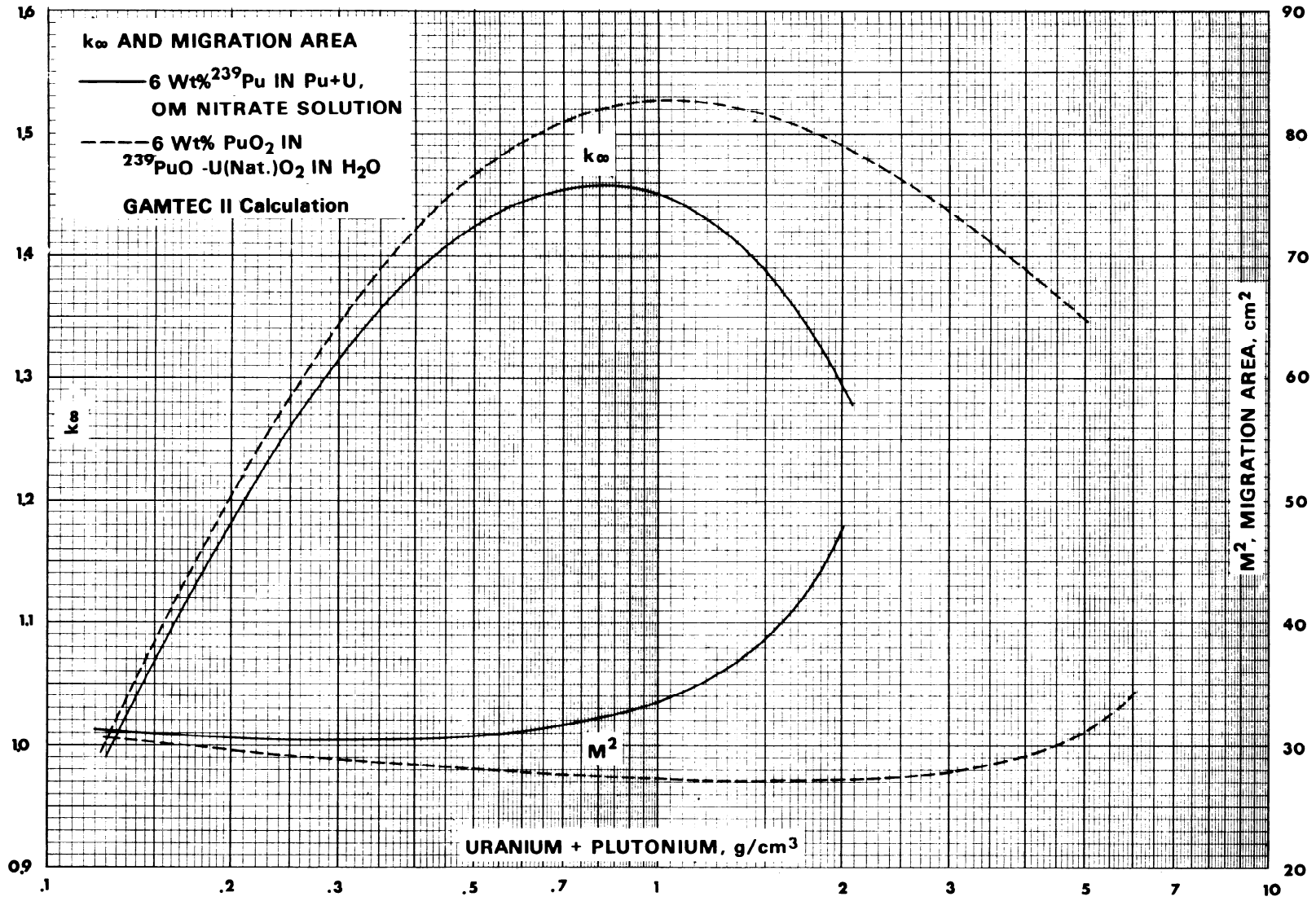

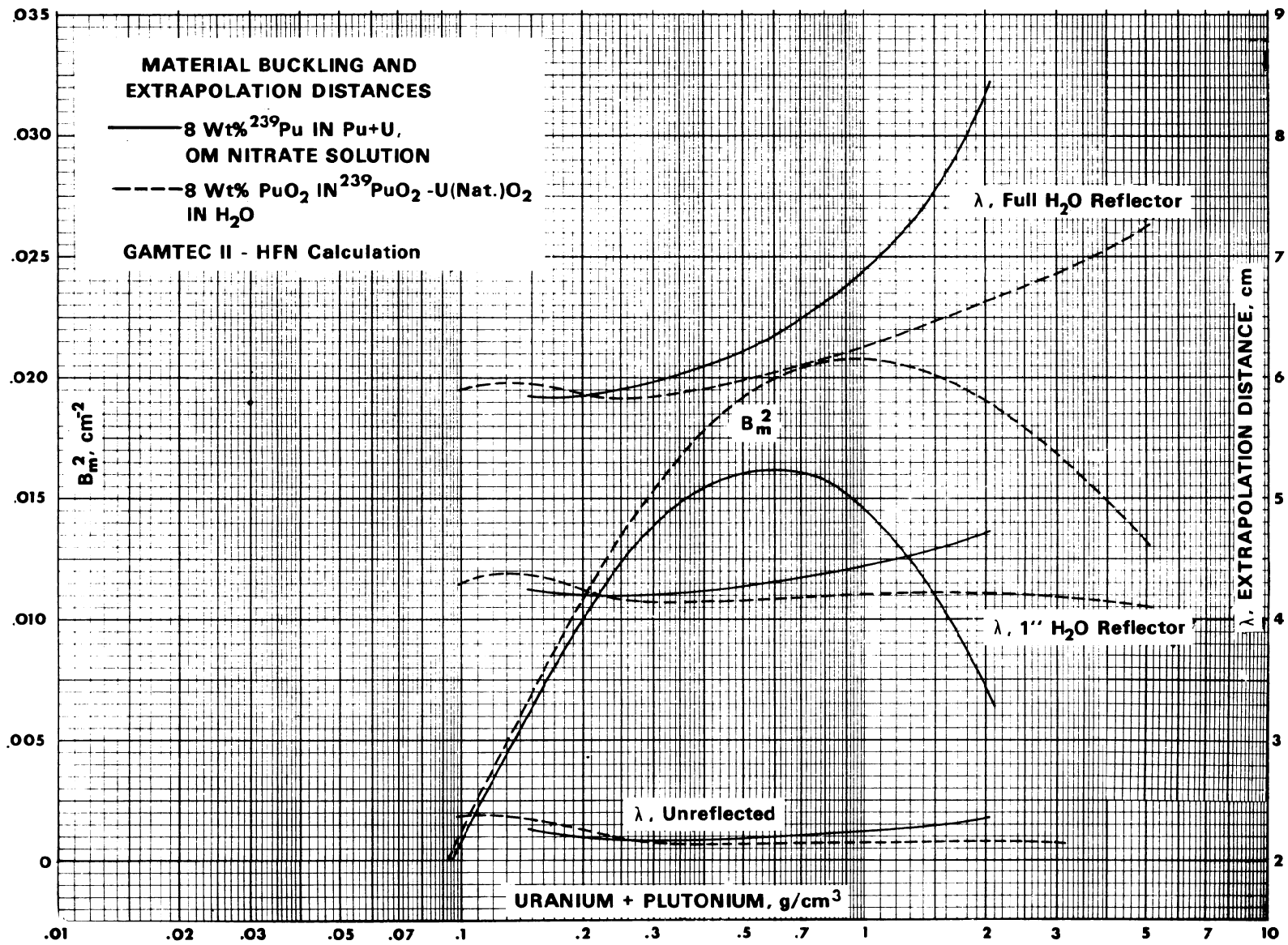

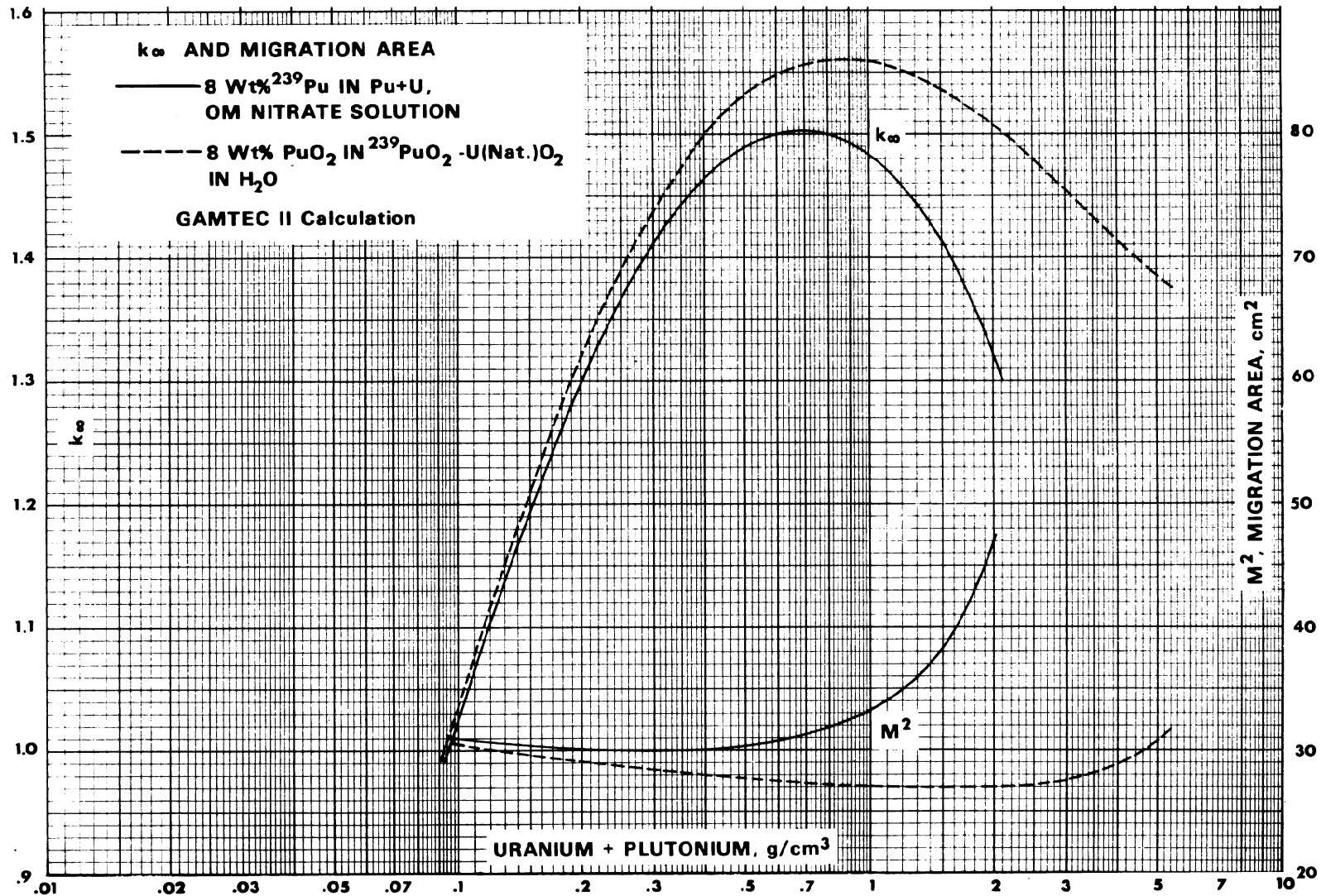

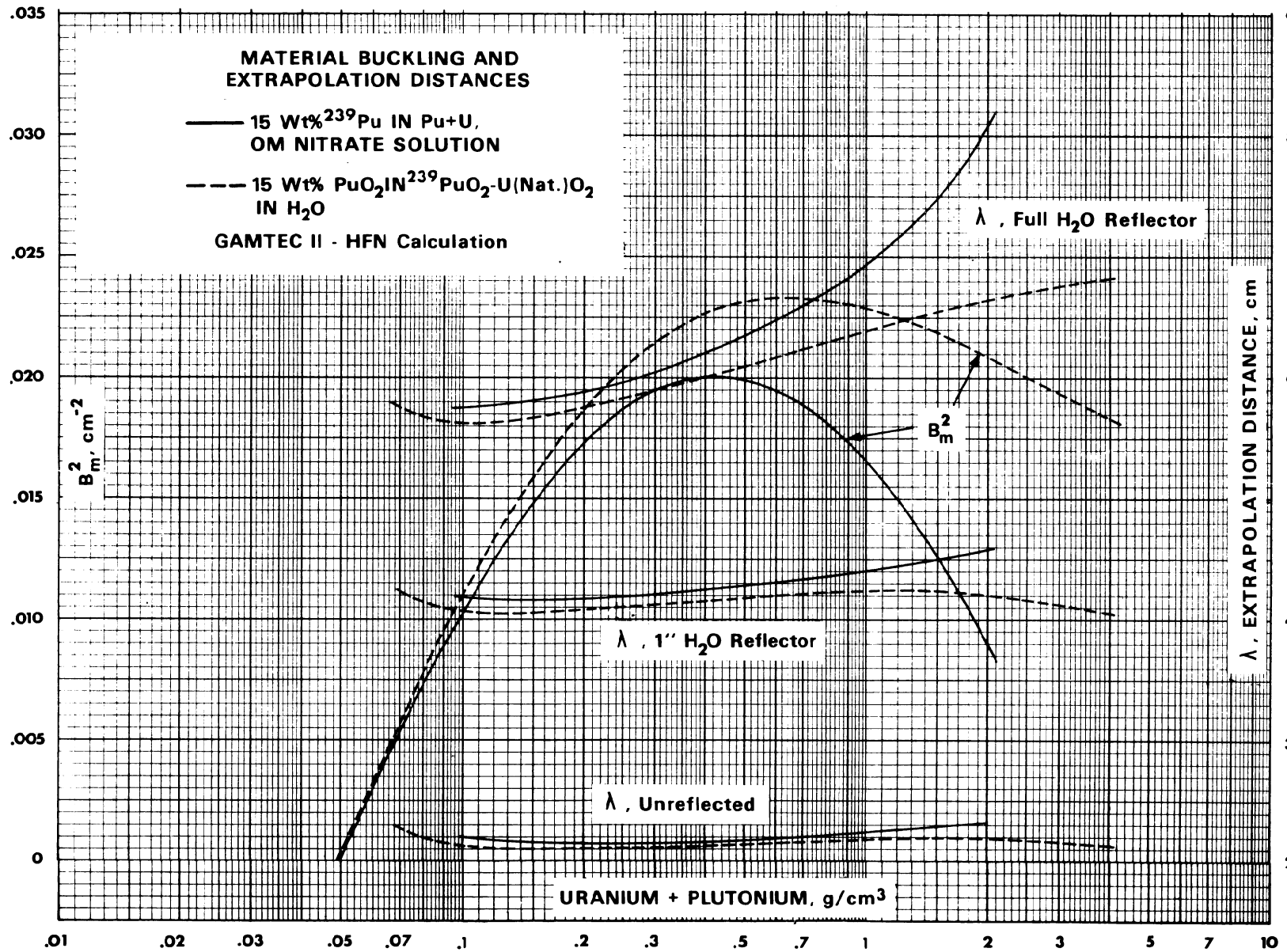

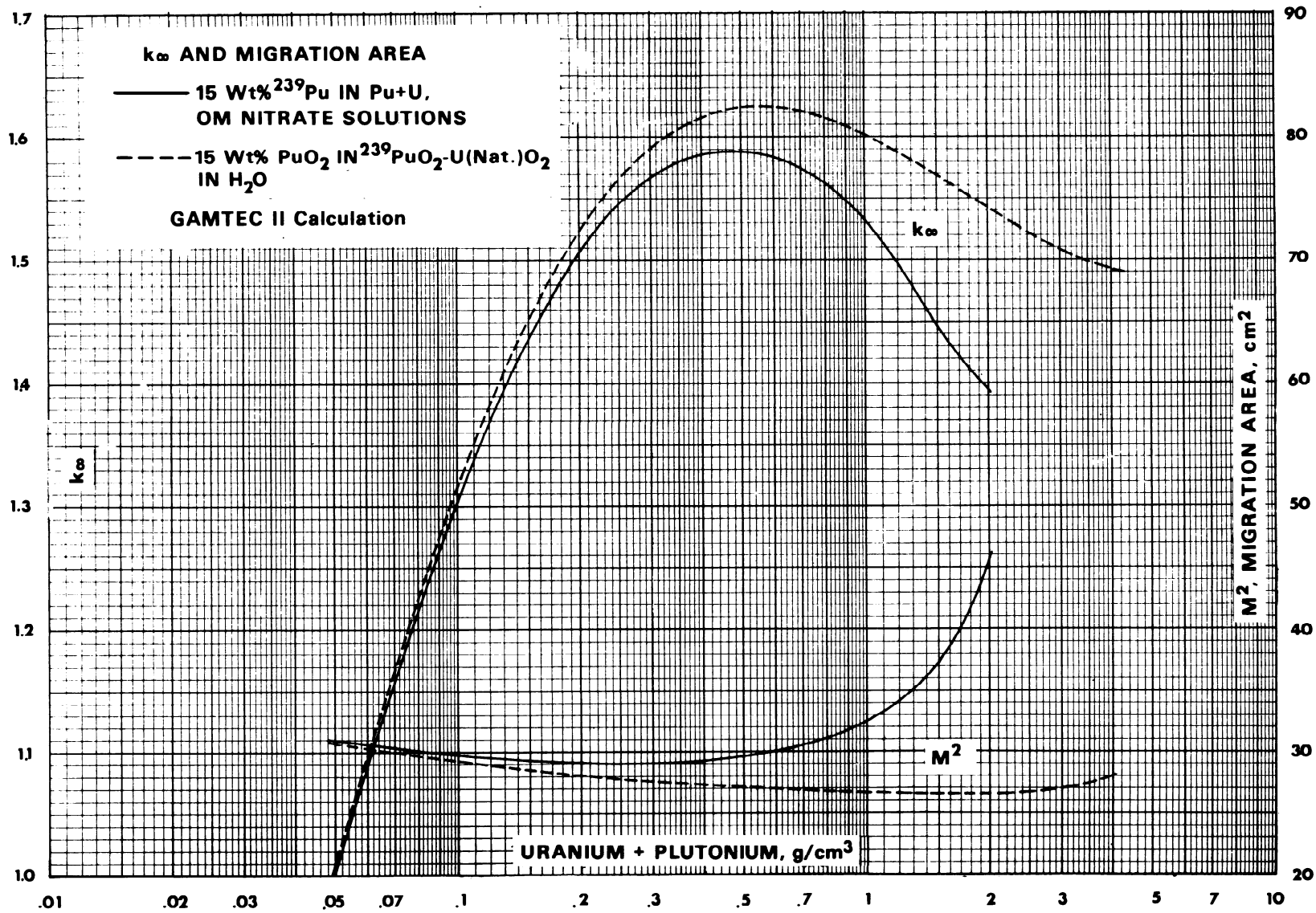

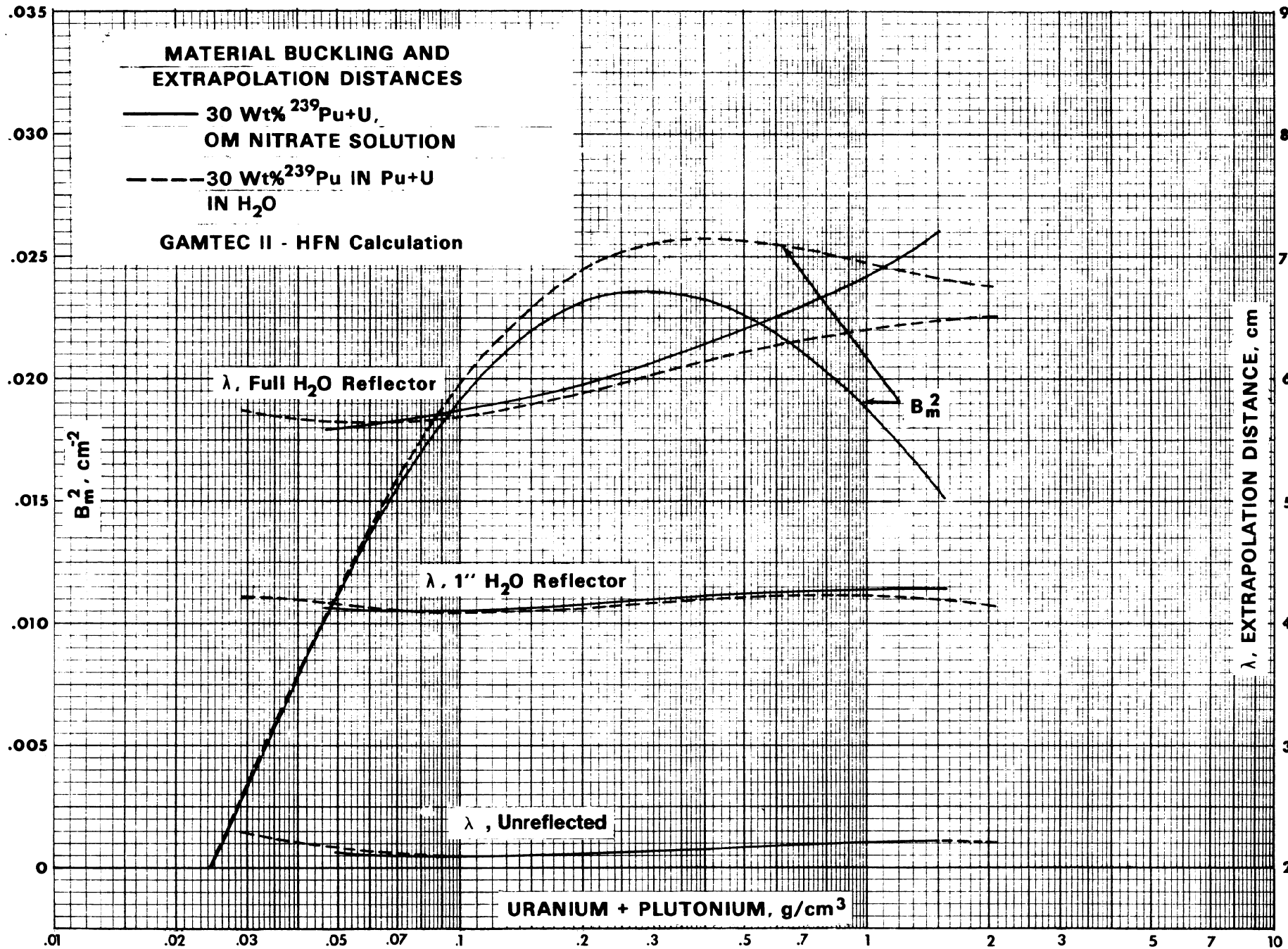

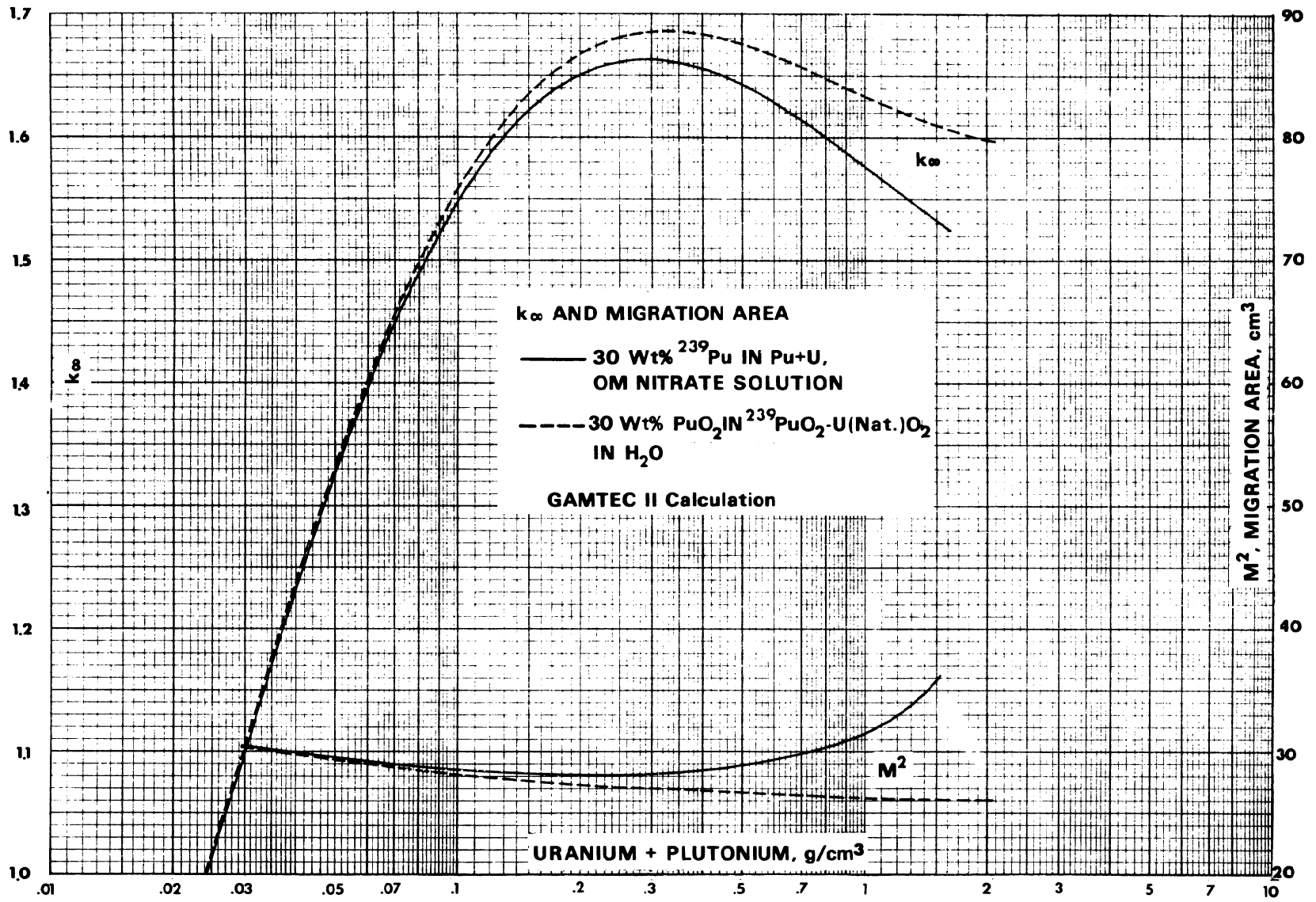

IV. HETEROGENEOUS DATA

- A. PLUTONIUM SYSTEMS
- B. URANIUM-235 SYSTEMS
- C. URANIUM-233 SYSTEMS
- D. MIXED AND MISCELLANEOUS SYSTEMS

COMMENTS ON DATA

The calculation of parameters for uranium rods is costly in both time and money if complete coverage is provided because of the number of variables involved. Different critical conditions may be obtained for different fuel materials, enrichments, rod diameters, water-to-uranium ratios, cladding material and cladding thickness.

Cladding fuel rods will generally tend to decrease critical limitations slightly for rods clad with materials such as aluminum or zirconium. For this reason, parameters in this section will be for unclad fuel. If it is desired to take advantage of the effect of a cladding, such as stainless steel which has a pronounced effect on critical limitations, it will be necessary to calculate this directly.

The uranium and uranium oxide data originally will be shown as the most limiting values for a given enrichment, i.e., for any rod diameter or lattice spacing. As time permits, more general curves showing variations with these parameters will be added.

The bulk of the uranium and uranium oxide data has been taken from work performed by H. K. Clark at the Savannah River Laboratory⁽¹⁾. This is a very elaborate work providing complete coverage of the effects of all the previously mentioned parameters on bare rods. A number of comparisons with this data has been made and these calculations appear to range from somewhat conservative at low enrichments to being the same at 5 wt.% U-235 enrichment. It does not appear necessary, therefore, to completely recalculate this data. Other calculations, less complete and slightly more conservative than those in DP-1014, may be found in AHSB(s), Handbook 1⁽²⁾.

Criticality parameters for materials other than uranium or uranium oxide have been calculated by the HAMMER code⁽³⁾. The calculations with this code compare favorably with the data in DP-1014. Calculations have been made with the original cross sections provided with the code (hereafter referred to as BNL cross sections) and with ENDF/B cross sections.

It is sometimes necessary to use a fixed value for the extrapolation distance, λ , with the buckling curves shown, either to reduce the complexity of the data or to insure against non-conservative calculations.

-
- (1) H. K. Clark, "Maximum Safe Limits for Slightly Enriched Uranium and Uranium Oxide", DP-1014.
 - (2) J. H. Chalmers, et al, "Handbook of Criticality Data, Volume 1", AHSB(s) Handbook 1, (1st Revision), 1967.
 - (3) J. E. Suich and H. C. Honeck, "The HAMMER System", DP-1064, January, 1967.

IV. HETEROGENEOUS DATA

A. PLUTONIUM SYSTEMS

1. Correlation Between Calculation and Experiment
2. Critical Sphere Dimensions
3. Critical Cylinder Parameters
4. Critical Slab Parameters
5. Critical Sphere Mass
6. Critical Sphere Volume
7. Material Bucklings and Extrapolation Distances

1.82 WT% Pu AND Al RODS IN WATER

.5 INCH DIAMETER, .033 INCH ZIR-
CALOY CLAD, 44 INCH LONG, 5.6
WT% ^{240}Pu

○ Experimental points, BNWL-801
▲ Calculated by HAMMER, using
BNL cross sections

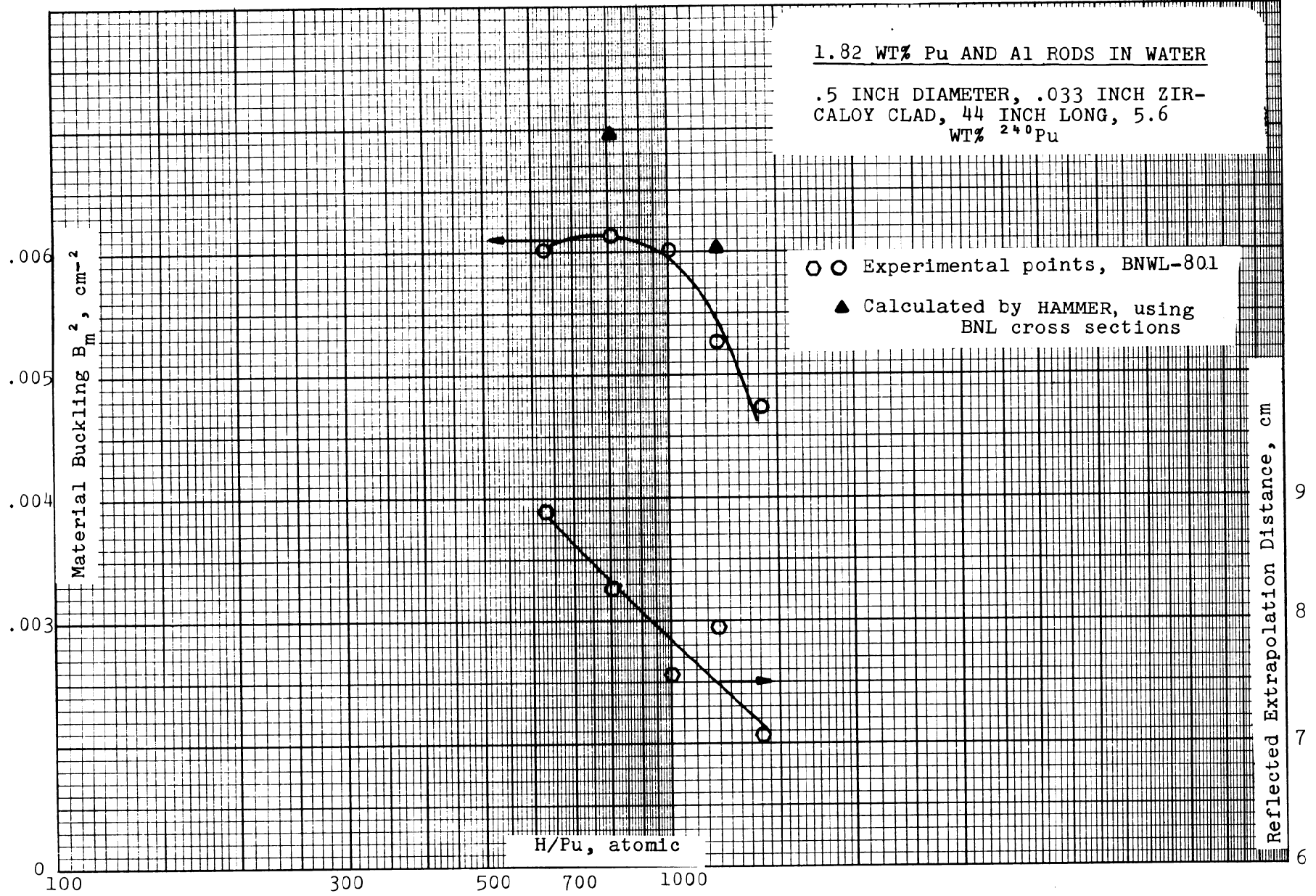

2 Wt% Pu & Al RODS IN WATER
 .5 IN DIAMETER, .033 IN ZIR-
 CALOY CLAD, 36 IN LONG, 16.5
 Wt.% ^{240}Pu

- ○ Experimental points, BNWL-801
- Calculated by HAMMER:
 using ENDF/B cross sections
- ▲ using BNL cross sections

Material Buckling, B_m^2 , cm^{-2}

Reflected Extrapolation Distance, cm

H/Pu, atomic

100

300

500

700

1000

3000

5000

8

7

6

5

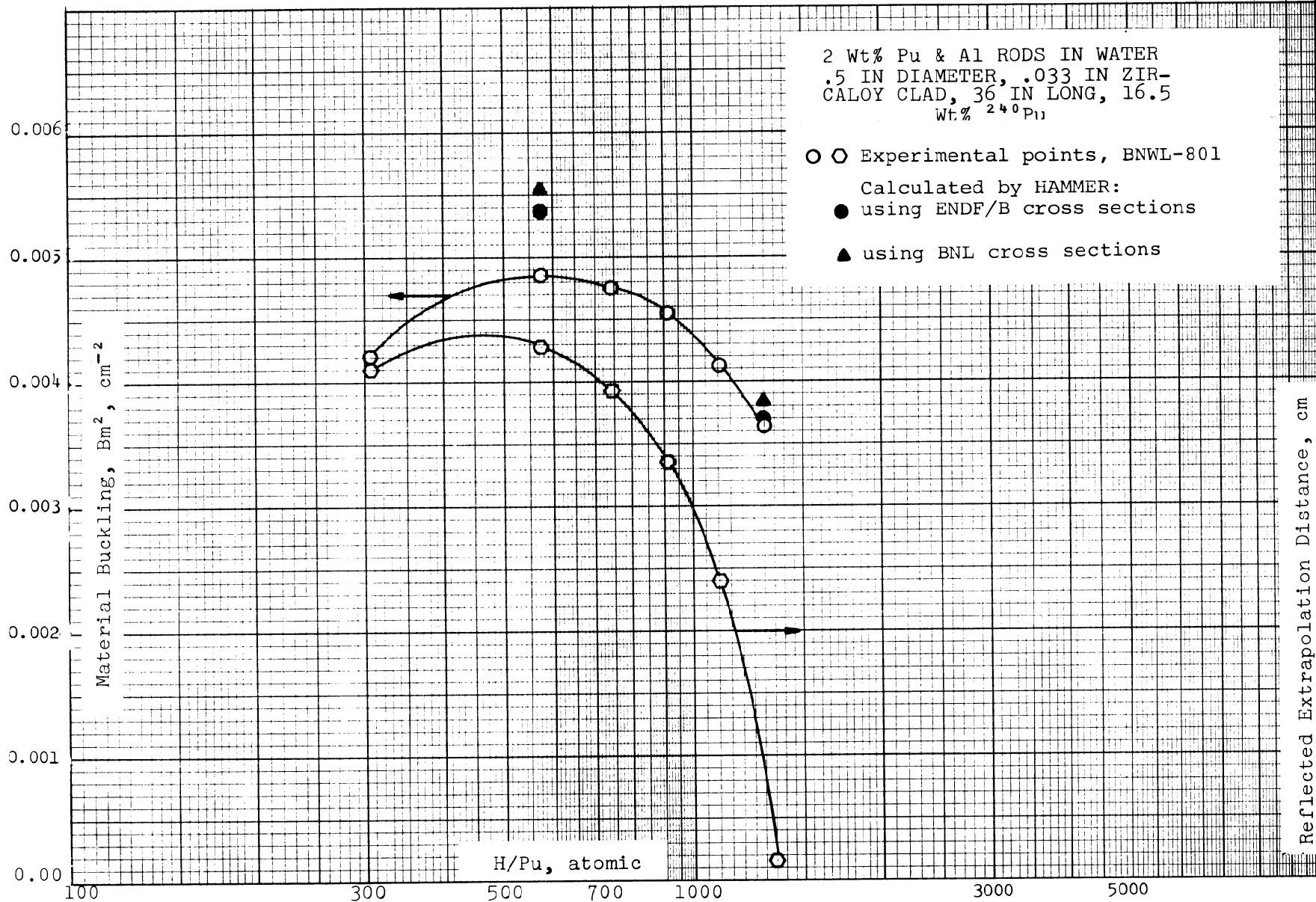

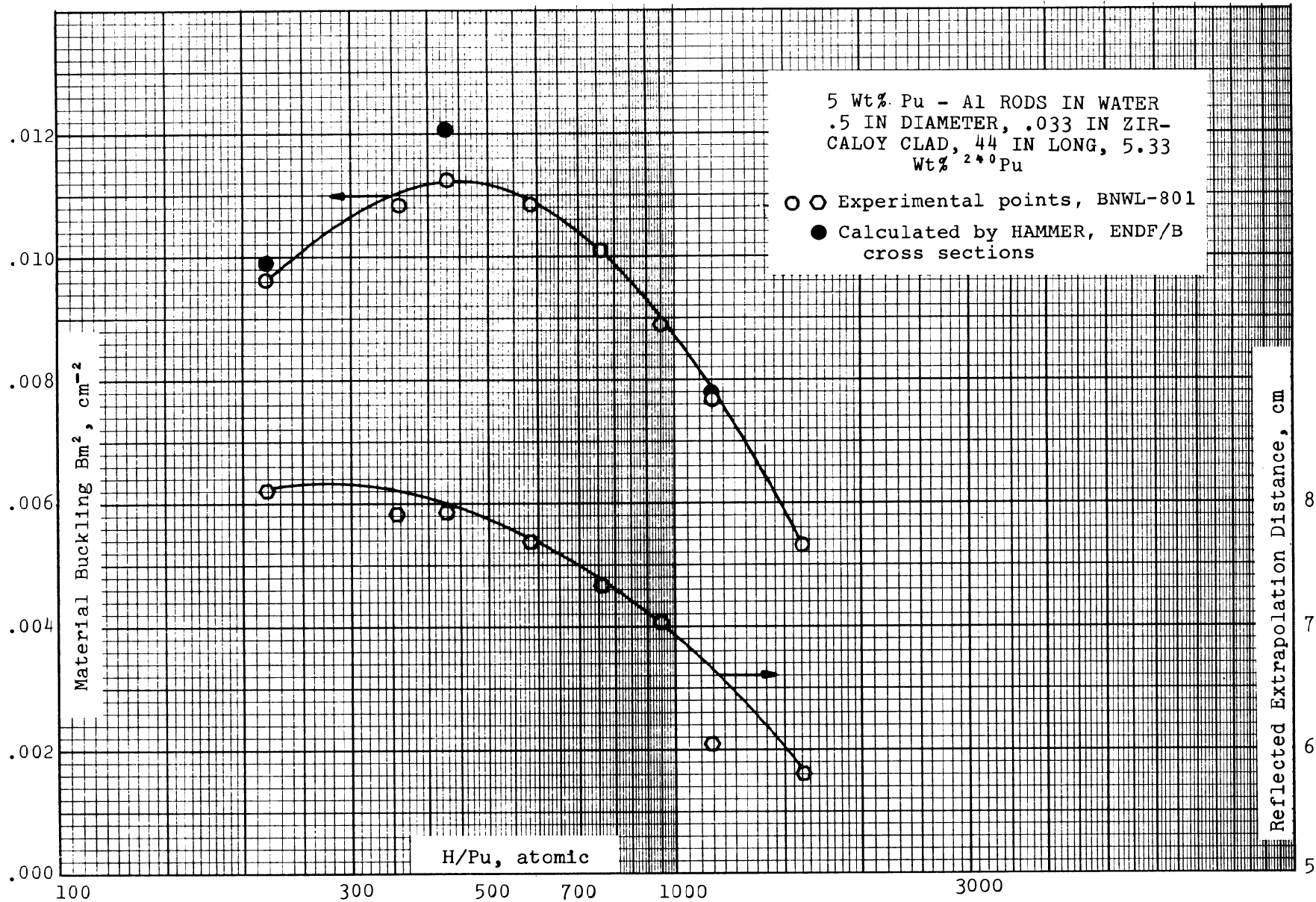

Two Region Metal - Solution Sphere

In 1963, a report was published by Messrs. W. A. Reardon and C. F. Czerniejewski which dealt with minimum critical mass calculations for a fully water-reflected, idealized (spherical) plutonium dissolver system⁽¹⁾. The report provided data on minimum critical masses, critical volumes, etc., for an idealized two-region (plus reflection) system representing plutonium-239 metal dissolving into solution. With the improved computer code calculation techniques available, a reanalysis was made in 1975⁽²⁾. The calculations were performed under the same general conditions as in the original document, the primary difference being the use of the DTF-IV transport theory code with GAMTEC II code cross sections in place of the original codes. In addition, the diffusion theory code HFN was used for the homogeneous system. Plutonium-water mixtures were used instead of plutonium oxide-water mixtures in the earlier work.

The system consisted of a plutonium metal core at a density of 19.6 grams/cc surrounded by a $^{239}\text{Pu-H}_2\text{O}$ mixture and fully reflected by water. The metal mass was held constant while the plutonium concentration in the mixture was varied. One of the relationships developed was the family of curves shown in Figure IV.A.5-2.

A line defining the envelope could then be drawn as shown, along the various curves, which defined the critical mass-volume relationship. The "always safe" terminology resulted from the fact that any mass-volume combination to the left of the envelope results in a subcritical system for a given total plutonium mass no matter how the plutonium is divided between the metal and metal-water mixture. (One should be aware, however, that these calculations are for a k-effective of 1.0. There is no allowance for possible bias).

(1) W. A. Reardon and C. F. Czerniejewski, "Idealized Plutonium Dissolvers and the 'Always Safe' Conditions," HW-SA-2999, General Electric Company, July 1963.

(2) C. O. Brown and R. D. Carter, "Reanalysis of Idealized Plutonium Dissolvers and the 'Always Safe' Conditions," ARH-LD-109, Atlantic Richfield Hanford Company, February, 1975.

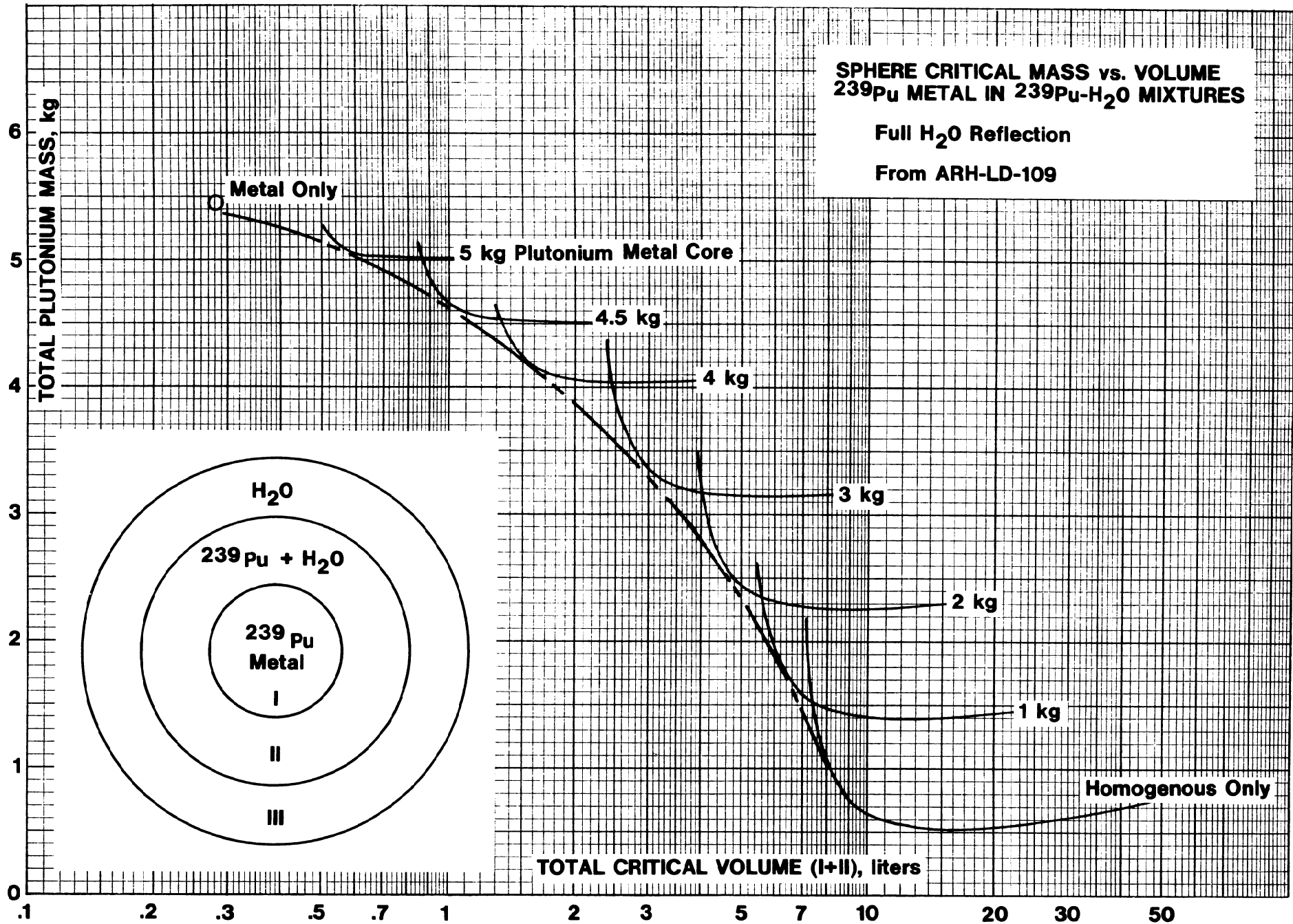

IV. HETEROGENEOUS DATA

B. URANIUM-235 SYSTEMS

1. Correlation Between Calculation and Experiment
2. Critical Sphere Dimensions
3. Critical Cylinder Parameters
4. Critical Slab Parameters
5. Critical Sphere Mass
6. Critical Sphere Volume
7. Material Bucklings and Extrapolation Distances

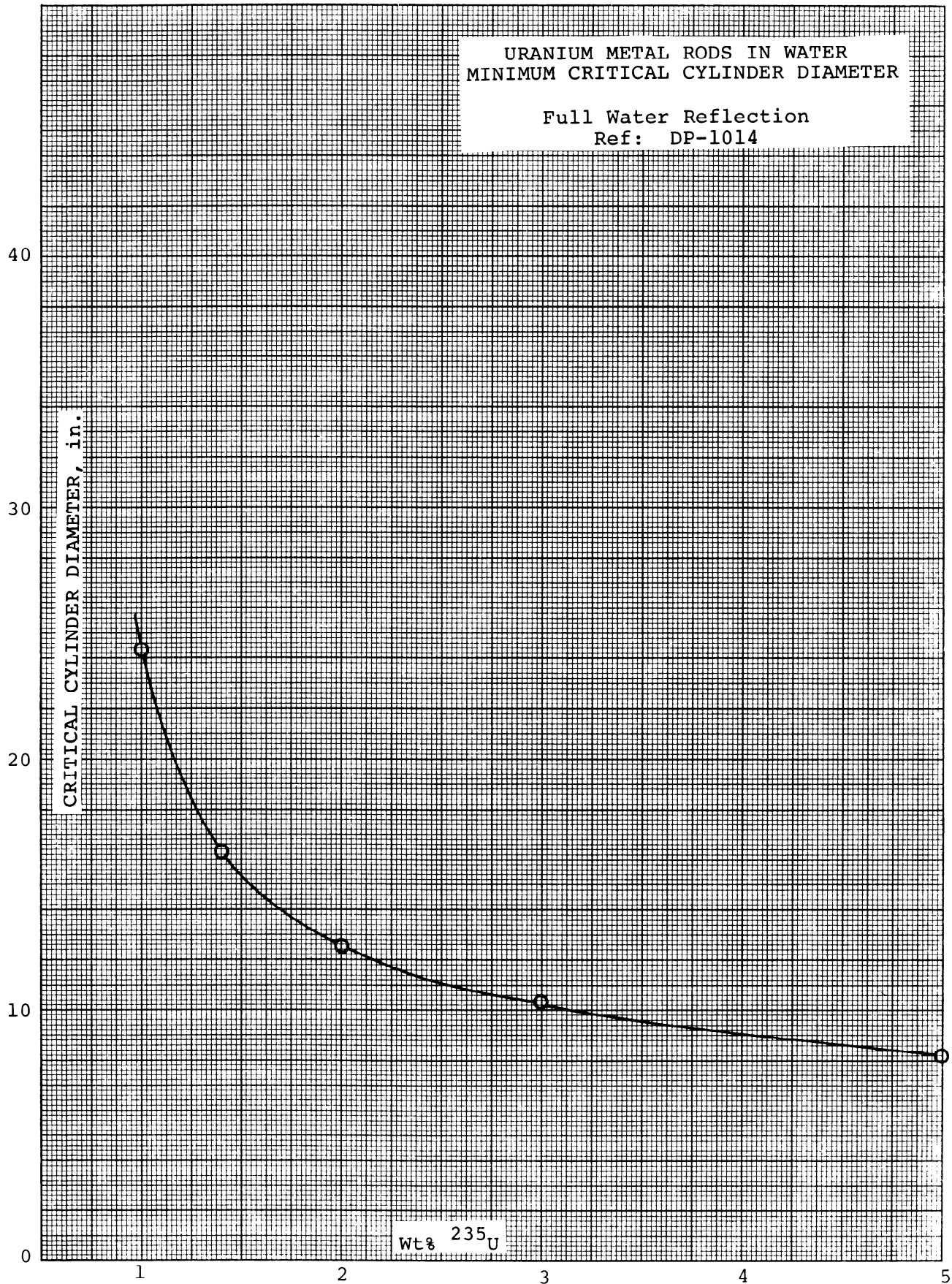

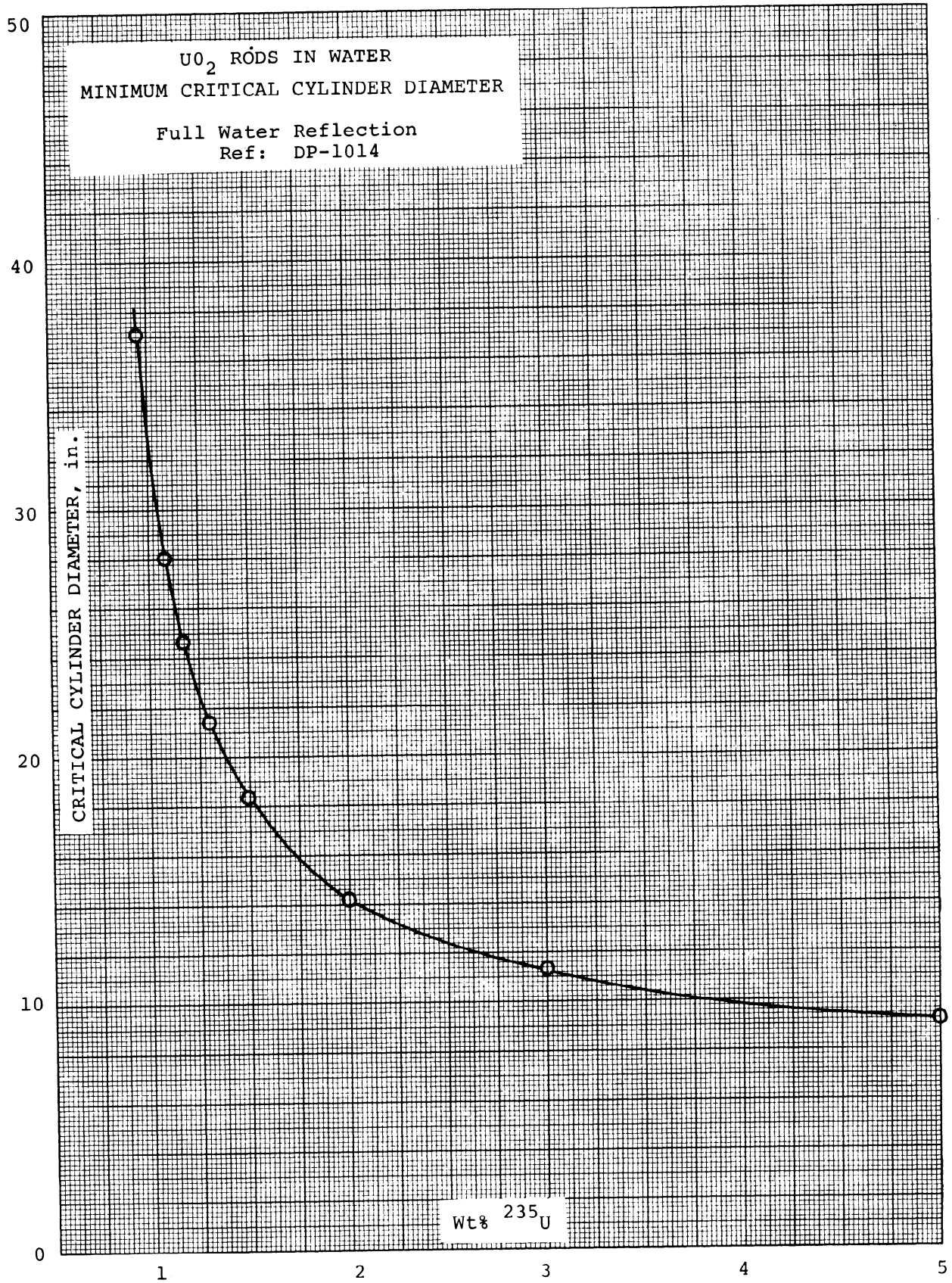

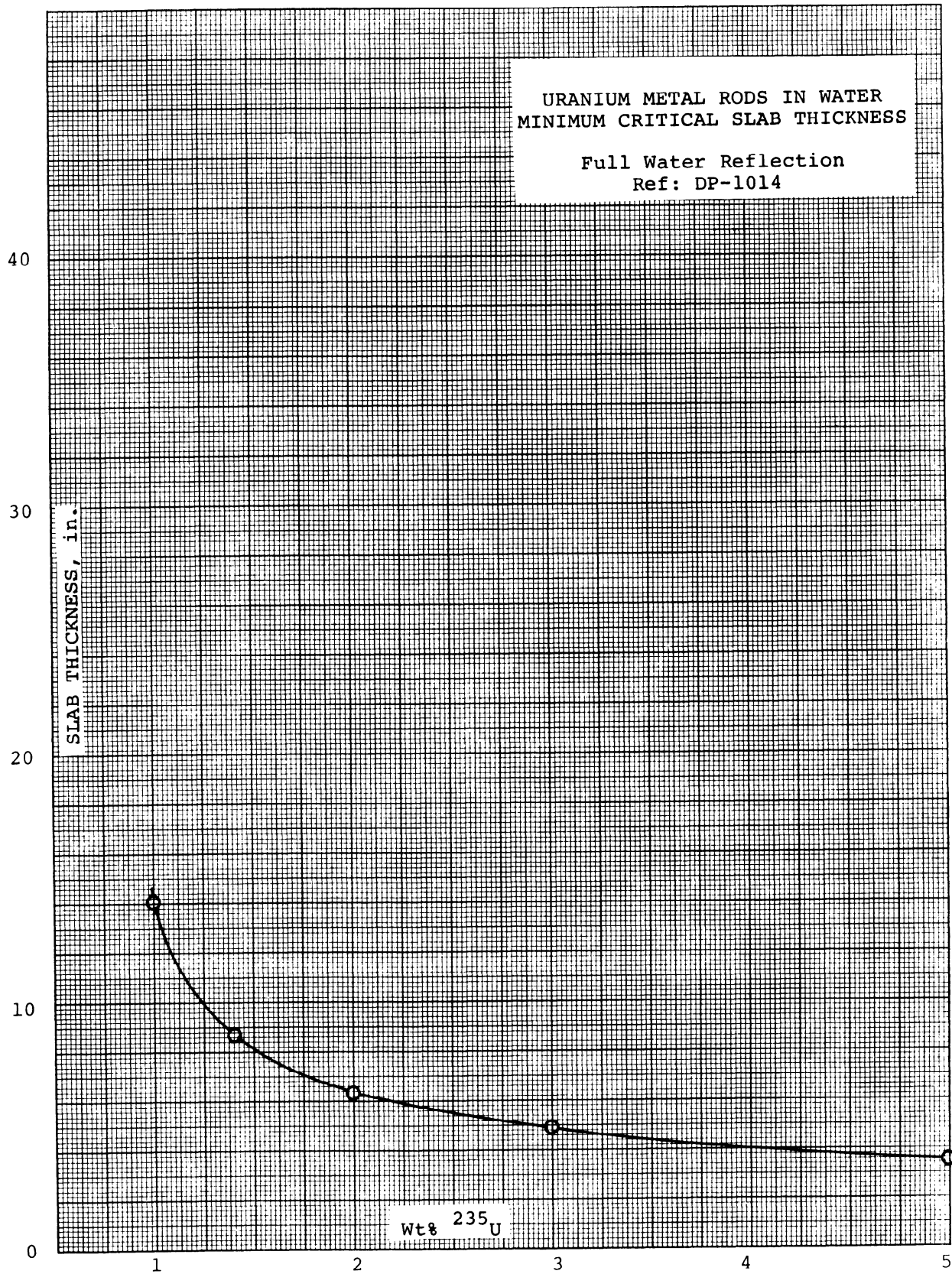

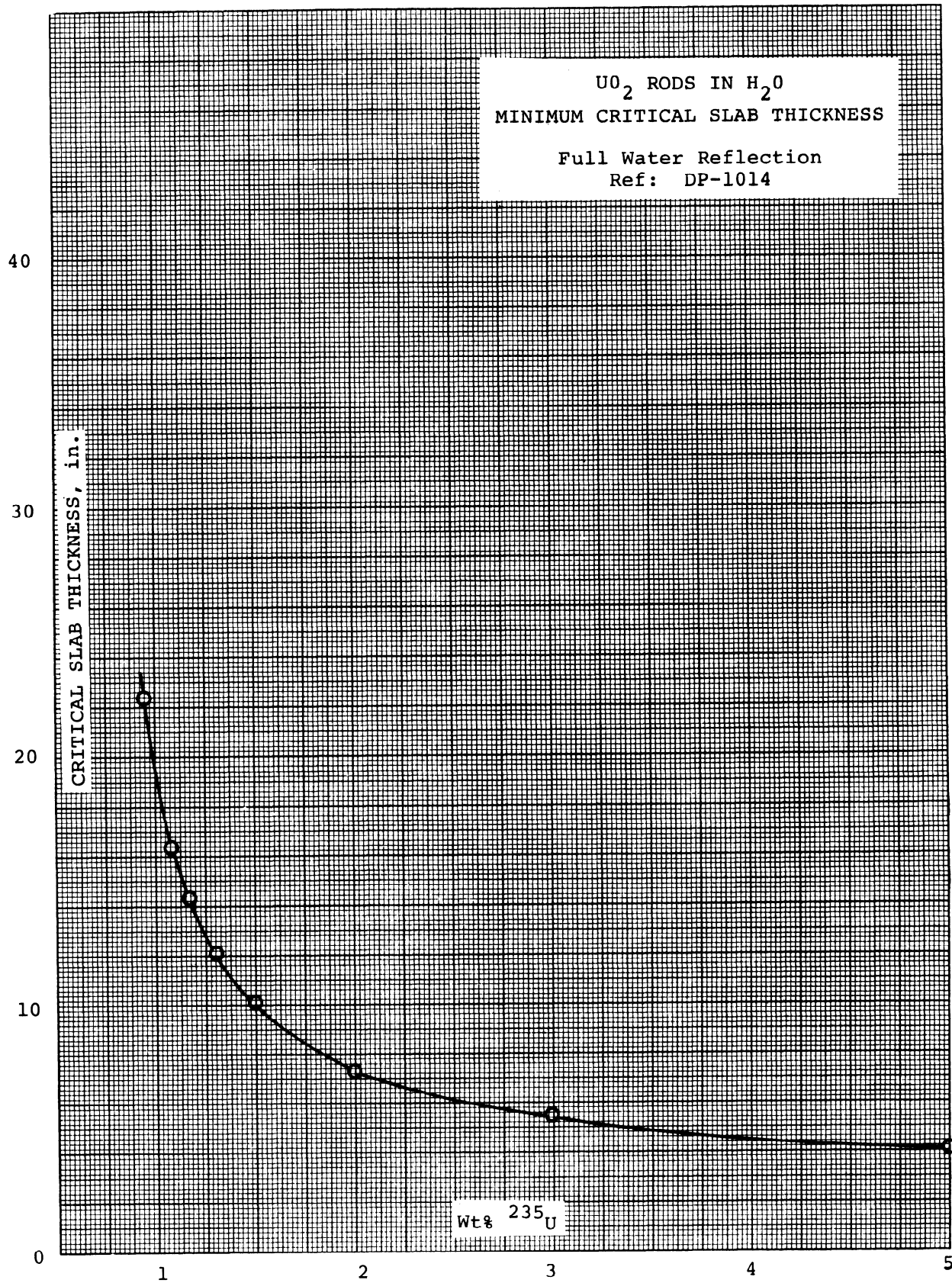

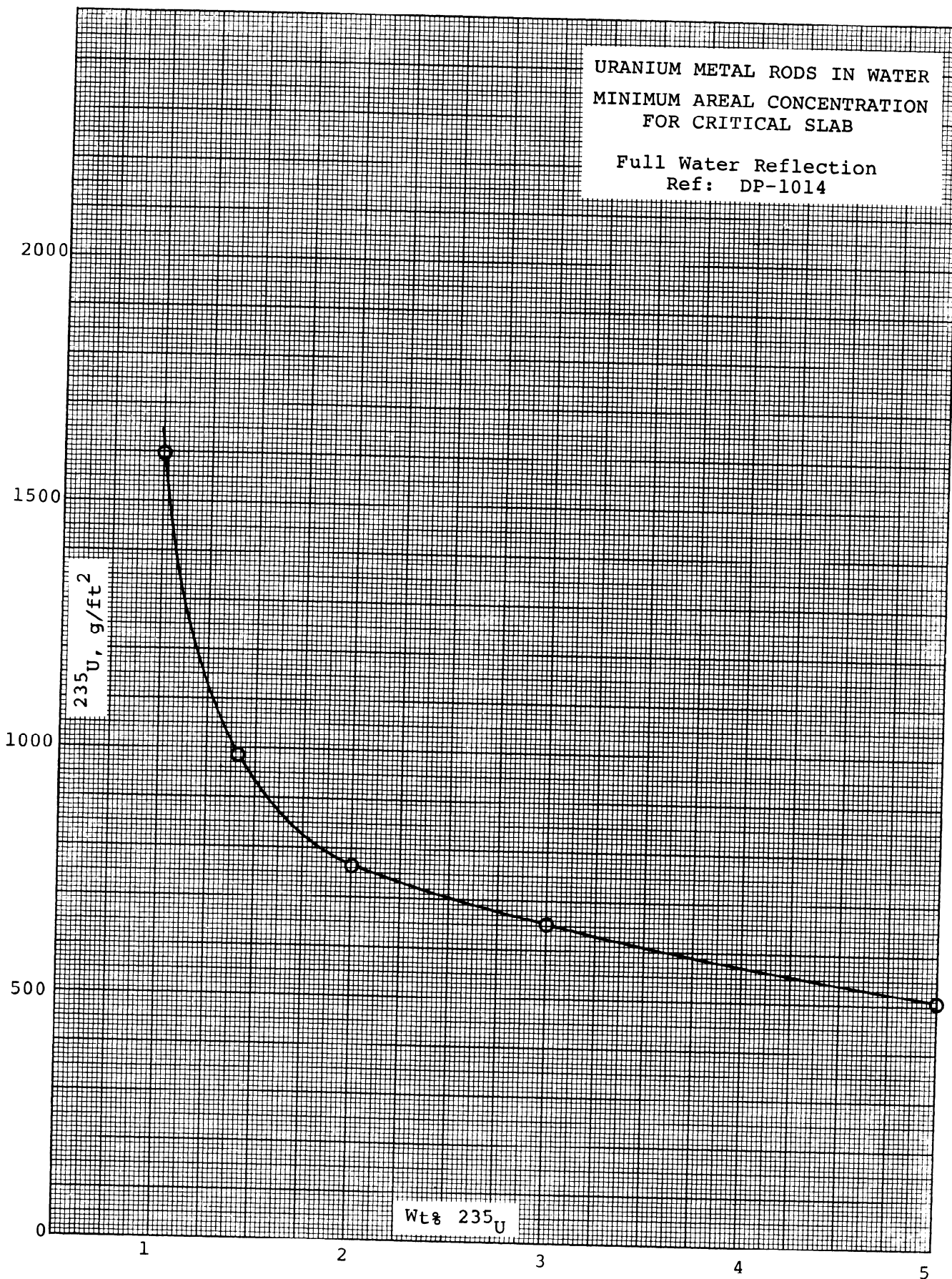

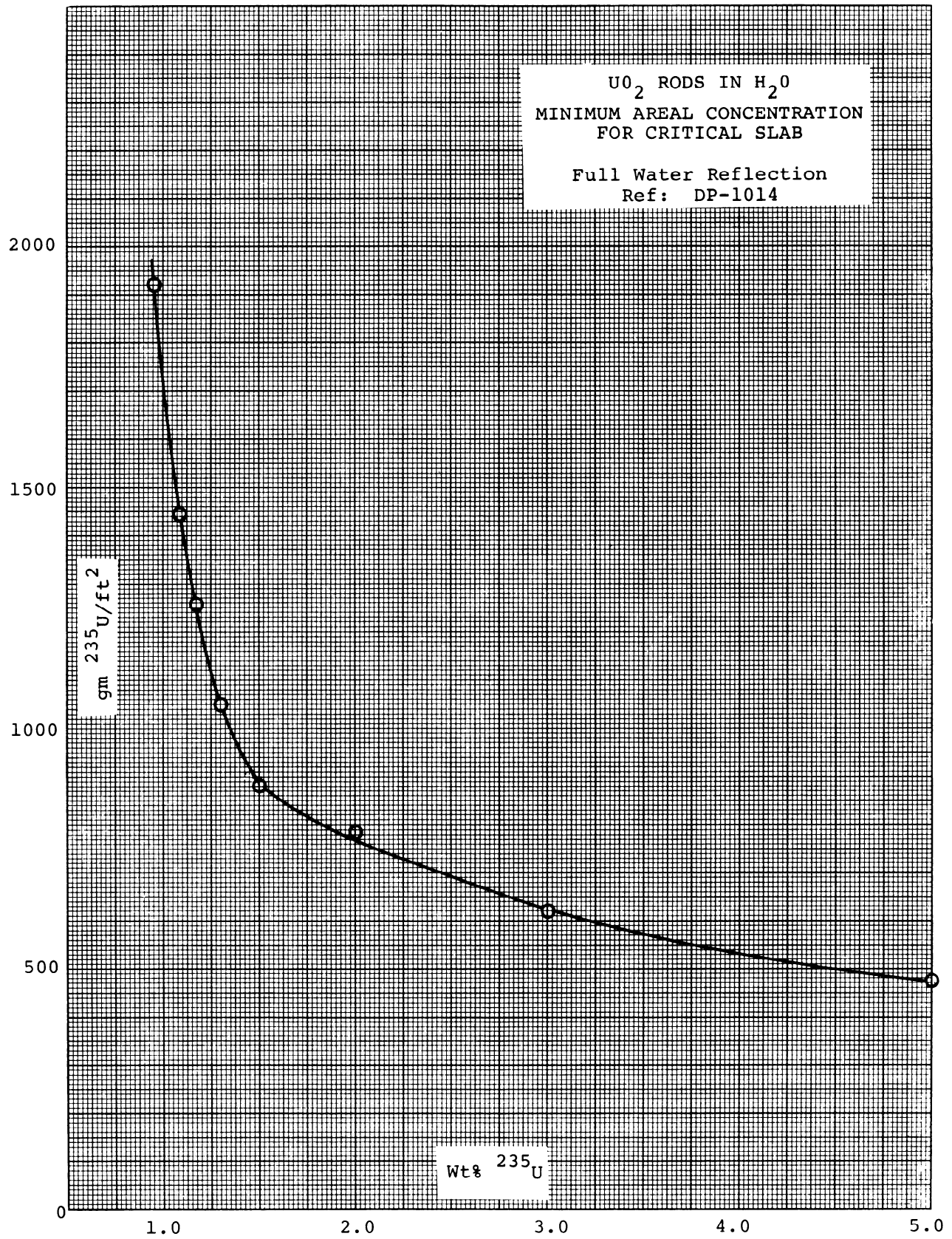

Revised 7/10/69

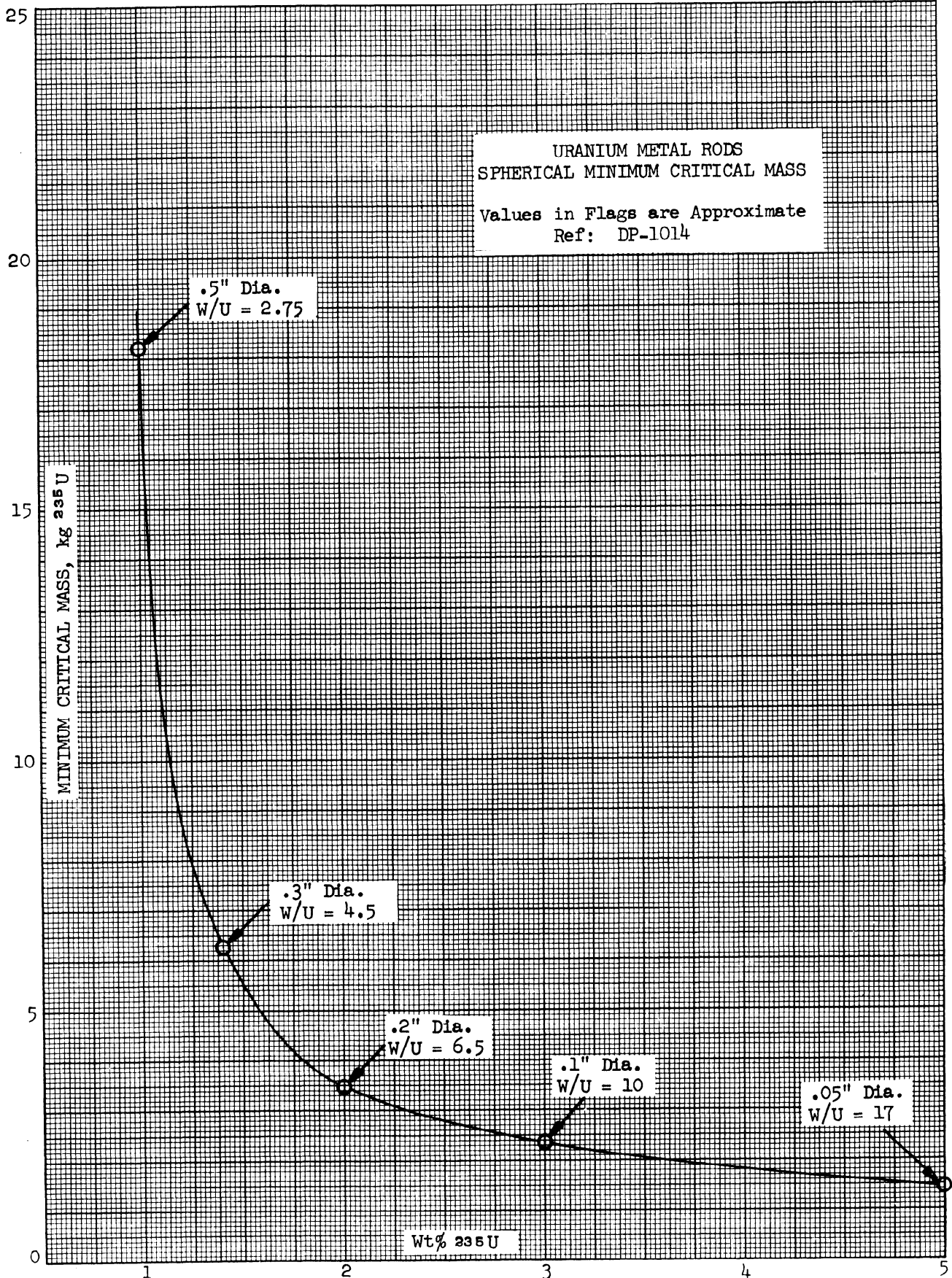

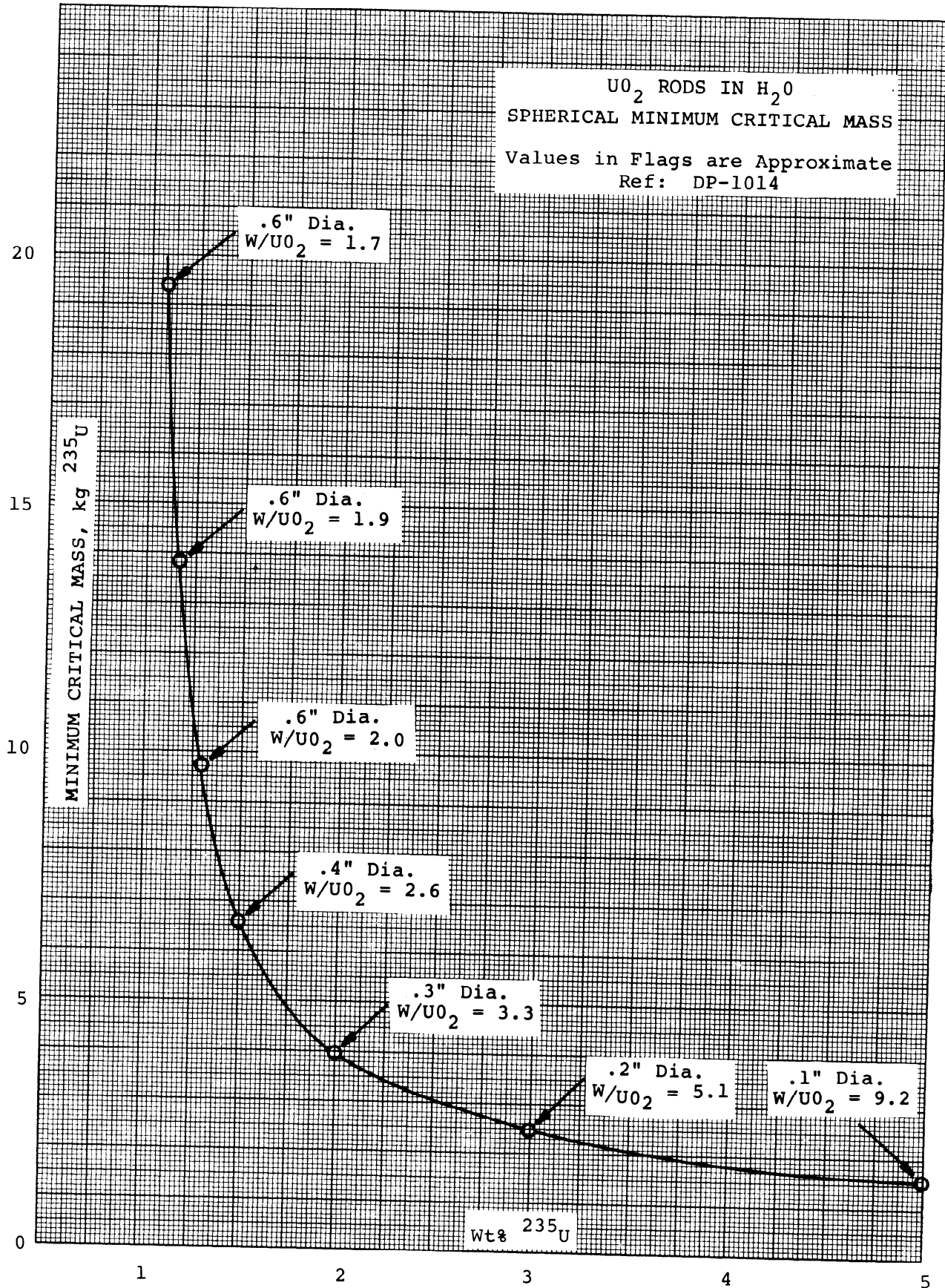

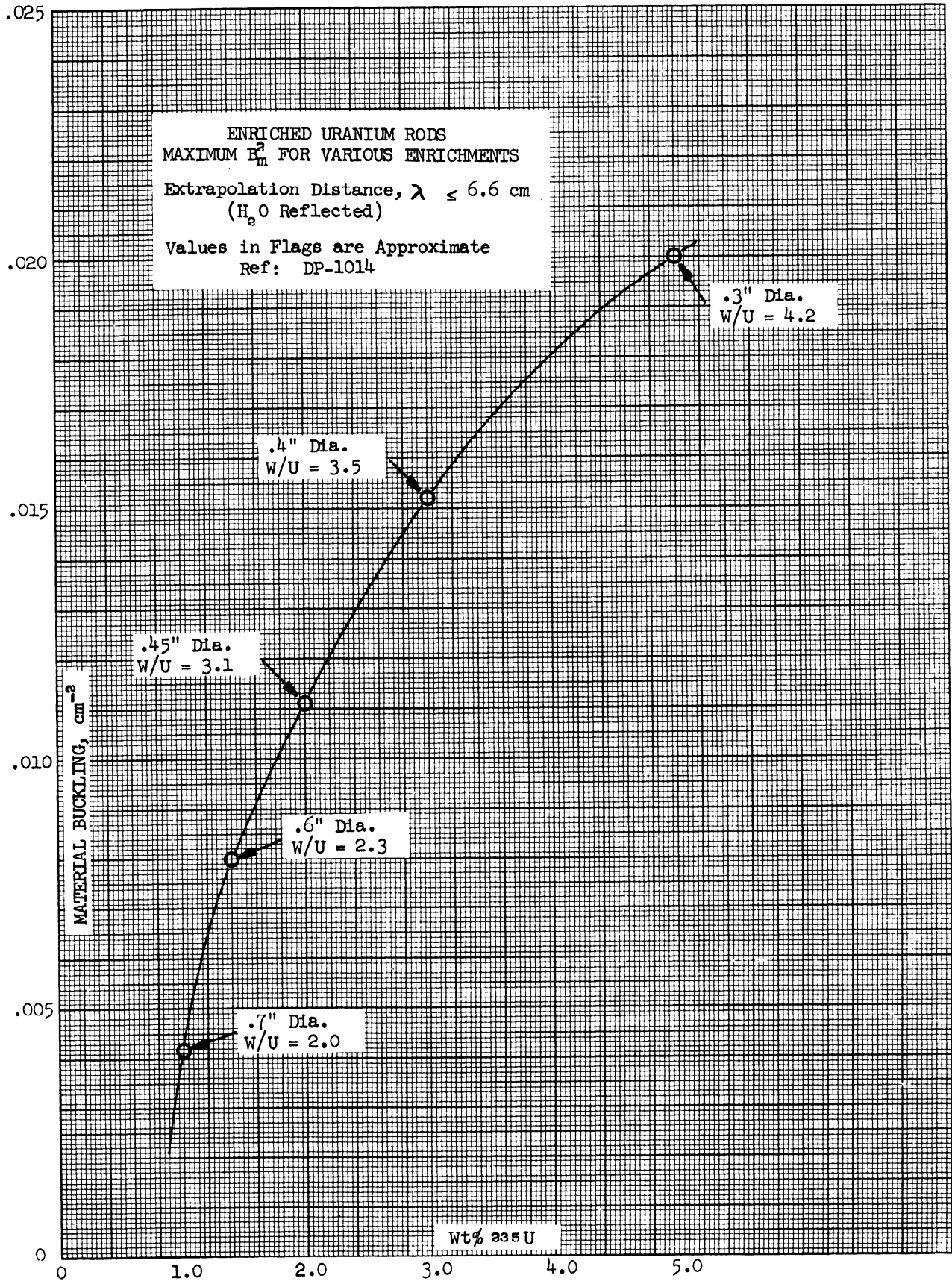

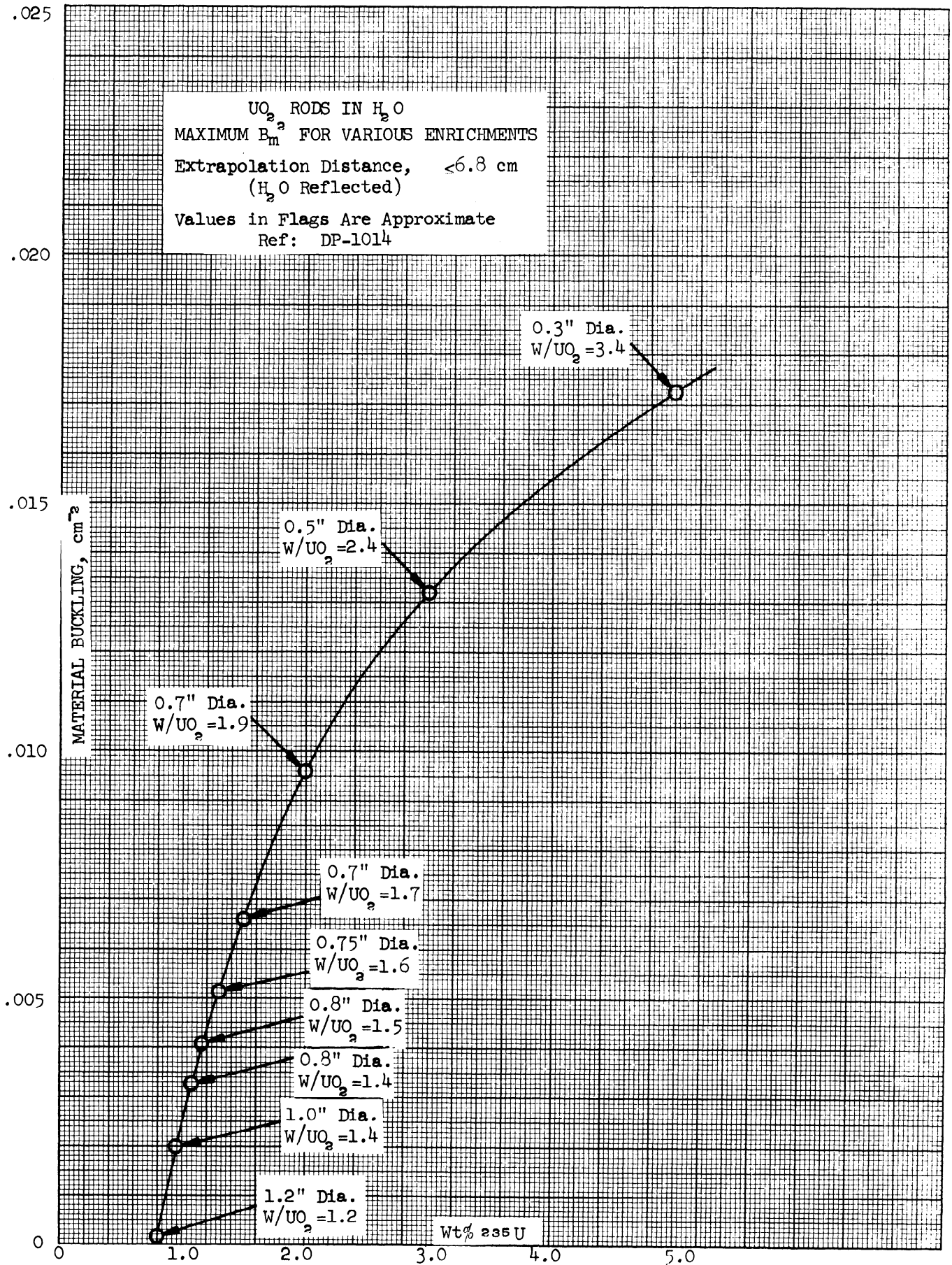

IV. HETEROGENEOUS DATA

C. URANIUM-233 SYSTEMS

1. Correlation Between Calculation and Experiment
2. Critical Sphere Dimensions
3. Critical Cylinder Parameters
4. Critical Slab Parameters
5. Critical Sphere Mass
6. Critical Sphere Volume
7. Material Bucklings and Extrapolation Distances

IV. HETEROGENEOUS DATA

D. MIXED AND MISCELLANEOUS SYSTEMS

1. Correlation Between Calculation and Experiment
2. Critical Sphere Dimensions
3. Critical Cylinder Parameters
4. Critical Slab Parameters
5. Critical Sphere Mass
6. Critical Sphere Volume
7. Material Bucklings and Extrapolation Distances

V. INTERACTION

A. INTRODUCTION

B. CORRELATION OF CALCULATION AND EXPERIMENT AND
EXAMPLES OF CALCULATIONAL PROCEDURES

1. Piping Intersections

2. Interaction Calculation, Solid Angle Method

3. Array Calculation, Density Analogue Method

4. Array Calculation, Other Methods and Codes

C. SUMMARY OF RECOMMENDED CALCULATIONAL PROCEDURES

D. USEFUL CURVES

A. INTRODUCTION

This section deals with the problem of neutron interaction between sub-critical units of an array or system. Many methods have been developed to cope with this most difficult problem and some of the more useful of these are reviewed or referenced here. Several actual sample calculations have been made using critical array experiments. An examination of these results will show that there is no one good method for interaction problems. Indeed, one method may yield safe results for one system and unsafe results for another system. Due to this uncertainty of results, the size of an array calculated by these methods should be used as a design guide only. Firm design would require clearance by a Criticality Specialist.

Neutron interaction must always be considered when fissile material is present except:

1. Where fissile units are separated by one foot of water or a material of equivalent hydrogen density.
2. Where the units are separated or shielded by another unit whose interaction has already been calculated.
3. Where all units combined constitute a safe mass or less.
4. Where all units are made up of homogeneous mixtures with the fissile isotope concentration less than 6 grams per liter.

The following array criteria is specified in Section I.C:

1. The individual units must be safe.
2. The array shall have a k_{eff} less than 0.98 for the worst foreseeable conditions.
3. Generally, the units should be separated by 12 inches to give isolation in case of water flooding.
4. Shipping containers and arrays must meet the requirements of Chapter 0529 of the U. S. Atomic Energy Commission manual; 10CFR71 and the Department of Transportation Regulations, 49CFR173.

B. CORRELATION OF CALCULATION AND EXPERIMENT AND EXAMPLES OF CALCULATIONAL PROCEDURES

1. PIPING INTERSECTIONS

a. Piping Intersections from Nuclear Safety Guide (1)

One of the most common types of interaction is between the various branches of a piping arrangement. The interaction between piping ells, tees, crosses or wyes, can be conservatively calculated using the following equation and Table I:

$$d_e = \left[\frac{\sum_i^n d_i^2}{n} \right]^{1/2} \quad (a)$$

where

d_e = the effective diameter

d_i = diameter of the i-th branch of the intersection

n = number of branches; 2 for ells, 3 for tees and wyes, and 4 for crosses

An intersection is safe if d_e is equal or less than the values in Table I.

An example would be a 6-inch I.D. pipe joined by a 4-inch pipe as a tee:

$$d_e = \left[\frac{(6)^2 + (6)^2 + (4)^2}{3} \right]^{1/2} = 5.416$$

From Table I, page V.B.1-2, this pipe intersection would be unsafe for all materials and systems except the minimal reflected ^{235}U system.

TABLE I
 RECOMMENDED INSIDE PIPE DIAMETERS* FOR INTERSECTIONS
 CONTAINING FISSIONABLE MATERIAL ($H/X > 20$) (1)

	Inside Pipe Diameter (in.)		
	<u>^{235}U</u>	<u>^{239}Pu</u>	<u>^{233}U</u>
Ells - Full Reflector	4.6	4.0	3.4
Nominal Reflector < 1" H_2O	5.3	4.7	3.8
Minimal Reflector < 1/8" S.S.	6.0	5.4	4.2
Tees - Full Reflector	4.2	3.8	3.2
Nominal Reflector	5.1	4.6	3.7
Minimal Reflector	6.0	5.4	4.2
Crosses or Wyes -			
Full Reflector	3.8	3.4	2.8
Nominal Reflector	4.9	4.4	3.5
Minimal Reflector	6.0	5.4	4.2

*Reduced diameters should extend 18 inches from intersection and no two intersections should occur within 18 inches.

b. Dickinson-Schuske Generalized Area of Intersection Model(26)

A more useful method of calculating the interaction effect of intersecting piping was recently proposed by Dickinson and Schuske. This method, entitled "The Generalized Area of Intersection" (GAI) method, is based upon experimental(27) data and calculational correlation with intersecting piping experiments carried out by the Rocky Flats Division of The Dow Chemical Company. The material for this model has been abstracted from the referenced article. The GAI model calculates both simple and complex intersections providing different limits on the intersection area and column size depending on the number of quadrants that contain arms. Although the experiments were carried out with enriched (93.1 wt% ^{235}U) uranyl nitrate, the results are conservative for plutonium nitrate solutions in the range of approximately 50 g/l to ≈ 650 g/l depending upon the ^{240}Pu content. (See page II.B.1-14).

Definitions

Diameter - Always the inner diameter of a pipe.

(Central) Column - The main column or pipe from which branching of arms occurs; the largest diameter pipe.

Arm - Any pipe or cylinder intersecting the central column.

Intersection Area - The area of intersection of an arm with the tangent plane of the column at the point where the axis of the arm intersects the column. (See Figure 1, where D = diameter, θ (Θ) = angle between arm axis and column axis, and A = area of intersection).

Sector - Any 18-inch length of the central column. (See Figure 2).

Quadrant - One-fourth of a sector; the sector is divided into four quadrants by two perpendicular planes intersecting along the axis of the sector. (See Figure 2).

Minimal Reflection - The reflection from the $\sim 1/8$ -inch-thick steel walls of the pipes only.

Nominal Reflection - Reflection from $1/8$ -inch-thick steel walls of the pipe plus $1/2$ -inch of water reflector (or an equivalent amount of reflection) around the pipes.

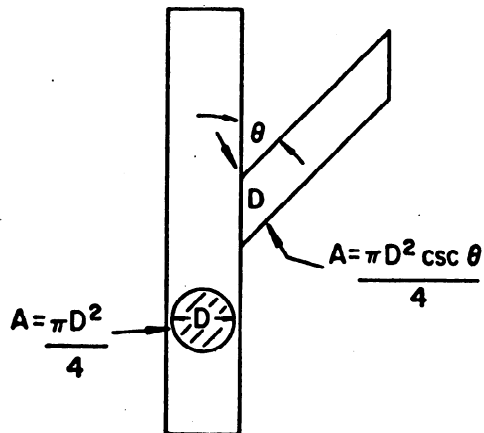

Fig. 1. Surface area in contact with central column.

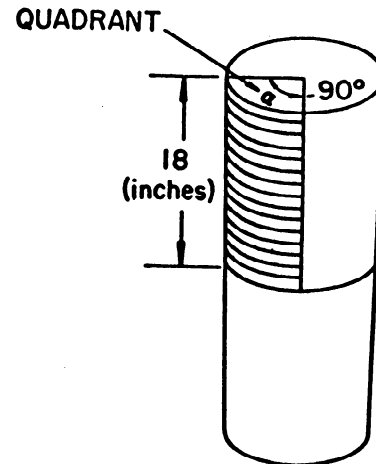

Fig. 2. Sector and quadrant definitions.

Full Reflection - Reflection due to full water flooding of a pipe system (pipes have 1/8-inch-thick steel walls); safe dimensions are calculated by reducing all diameters in the minimal cases by a factor of 0.635.(27)

Since the experimental information was limited and since the O5R code(28) had shown acceptable accuracy in reproducing experimental results, the O5R code was used to generate the necessary critical data. Later, calculations were performed to verify that the safe dimension pipe systems actually were far subcritical ($k_{eff} + 4\sigma < 0.95$).

The procedure used to derive the safe dimensions of the GAI model is to first select arbitrarily a reasonable central column diameter and then to calculate critical arm diameters for the case of minimal reflection for the following configurations: (a) the simple repeating T (one quadrant per sector), and (b) two quadrants per sector. The cases for 3 and 4 quadrants per sector are combined and are handled as presented in reference 27. Safe dimensions were obtained from these critical cases by reducing the central column diameter and the arm diameters by 10 to 15 percent. The safe dimensions for nominally and fully reflected systems were obtained by applying a reflector savings correction to the data for minimally reflected systems.(27)

All previous models had been limited to the case of a single central column, leaving it up to the user to decide when a second column was sufficiently far away to be considered isolated. No experimental results exist for the case of interconnected pipe systems, each consisting of a central column with attached arms. However, data on the interaction of cylinders (i.e., columns) indicate that interaction decreases rapidly with distance between cylinders. Since the increase in k_{eff} due to a second column at a separation of two feet was less than one standard error, the two-foot distance was selected as the

minimum separation permitted by the GAI model. Because of the smallness of the change produced by adding a second column, it is inferred that a third column would also produce an acceptably small change in k_{eff} , although no calculations were done to study the effect of a third column. An example (see Example 2) is presented of a system containing three interconnected columns, and an O5R calculation verified that the diameters and separations calculated by the GAI model are safe.

Rules Defining the GAI Model

1. The area of intersection of the arms with the column must be calculated for all quadrants containing arms, and the calculated area must not exceed the maximum value given in Table II for the appropriate number of quadrants used and reflection condition. The intersection area must be distributed in such a way that it is impossible to find any quadrant which contains more area than that permitted by Table II.
2. The central column diameter must not be greater than the appropriate limiting value given in Table II.
3. A maximum of three columns is permitted, and the center-to-center distance between any pair of columns must be at least two feet.
4. For the case of nominal or full reflection, a maximum of four arms per quadrant is permitted. There is no limitation on the number of arms per quadrant in the case of minimal reflection.

Examples

The following examples illustrate the application of the GAI model. In each case, the goal is to maximize pipe diameters and minimize spacings. All pipes are assumed to be filled with enriched (93.1% by weight ^{235}U) uranyl nitrate solution at a concentration of 450 g/liter of uranium, and minimal reflection is assumed.

TABLE II
Maximum Intersection Areas and Column Diameters Permitted by the GAI Model

Number of Quadrants Containing Arms in a Sector	Minimal Reflection		Nominal Reflection		Full Reflection	
	Maximum Central Column Diameter (in.)	Maximum Intersection Area per Quadrant (sq. in.)	Maximum Central Column Diameter (in.)	Maximum Intersection Area per Quadrant (sq. in.)	Maximum Central Column Diameter (in.)	Maximum Intersection Area per Quadrant (sq. in.)
1	7.25	41.28	6.25	30.68	4.60	16.62
2	7.00	29.70	6.00	20.83	4.44	11.98
3 or 4	6.50	23.75	5.50	16.00	4.12	9.60

Example 1 (See Figure 3)

Note that arms 1-6, all of diameter d_2 must be placed in the same sector. Assume that the separation, S , is large enough to put arms 7-10, all of diameter d_3 , in a separate sector. For the first sector (arms 1-6), only two quadrants contain arms, and hence each quadrant is permitted 29.7 square inches of intersection area, giving

$$d_2 = \sqrt{\frac{4}{\pi} \left(\frac{29.7}{3} \right)} = 3.55 \text{ inches}$$

For the sector containing arms 7-10, the four quadrants are used, and hence d_1 , the column diameter, is 6.5 inches, and $d_3 = 5.5$ inches.

Finally, the separation, S , must be chosen large enough so that no quadrant contains more intersection area than permitted by Table II. This is accomplished by setting $S = 18 \text{ inches} - 3.55 \text{ inches} = 14.45 \text{ inches}$.

By comparison, the maximum arm diameters permitted by the GEC model (see page V.B.1-9 - section on comparison of GEC and GAI) for a 6.5-inch column are $d_2 = 3.72$ inches and $d_3 = 5.02$ inches.

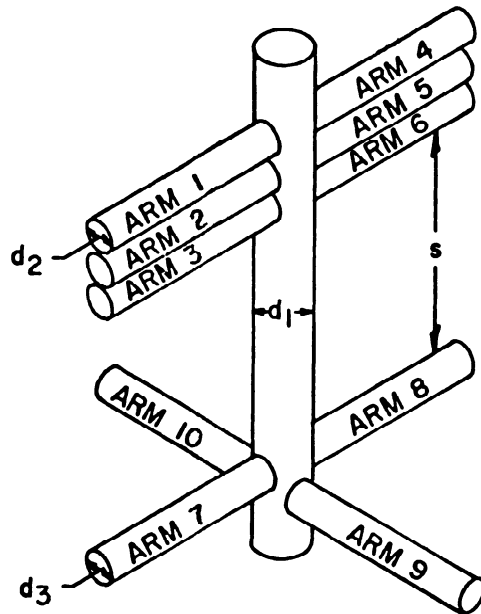

Fig. 3. Geometry for Example 1.

Example 2 (See Figure 4)

Consider first the spacing of the columns, since that is independent of arm or column diameters. The distances S_1 and S_2 must each be 24 inches; then the distance between columns 1 and 3 is $24\sqrt{2}$ inches.

For column 1, there is only one sector to consider, and it has two quadrants containing arms. Therefore, column 1 may have a diameter of 7.0 inches, and each quadrant may contain 29.7 square inches of intersection area; thus, arm 2 may have a diameter of 6.15 inches and arm 1, which is at 45 degrees, a diameter of 5.17 inches. Note that the diameter of arm 2, which also intersects column 2, may have to be reduced to make column 2 safe.

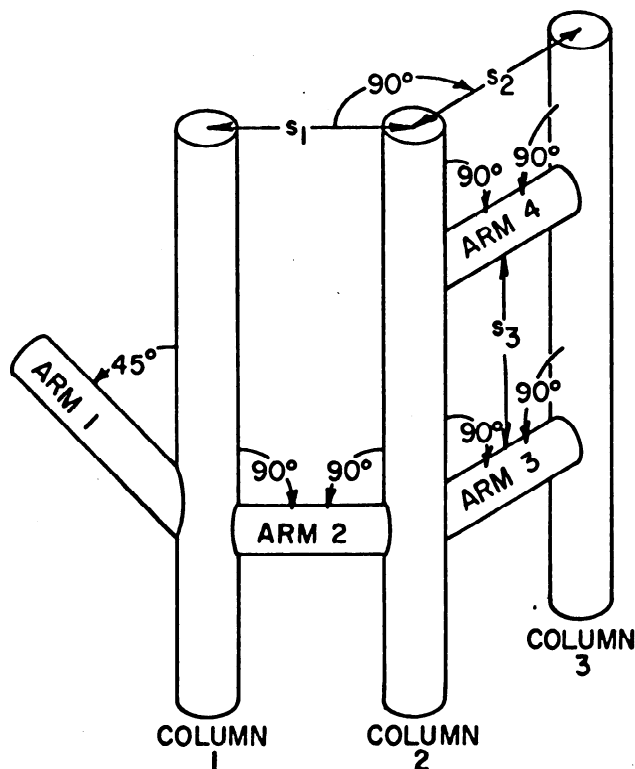

Fig. 4. Intersecting system with three columns. Permissible pipe diameters are calculated in Example 2.

Regarding column 2, assume that the distance S_3 will be chosen so that arms 3 and 4 are in different sectors. Then the sector containing arm 4 uses only one quadrant. However, the sector containing arms 2 and 3 has two quadrants containing arms, and hence column 2 is limited to a diameter of 7 inches. Arms 2 and 3 may each be 6.15 inches in diameter (so the previously assigned diameter for arm 2, relative to column 1, is allowed to stand). Arm 4, which is permitted

41.28 square inches of intersection area (corresponding to a diameter of 7.25 inches), can be only 7 inches in diameter, since the arm diameter cannot be larger than the column diameter.

Finally, column 3 has two sectors to consider, each of which contains only one arm. Hence, column 3 may have a diameter of 7.25 inches. Arms 3 and 4 are also permitted 7.25-inch diameter, so the smaller diameters already assigned also satisfy the safety criteria for column 3.

Setting $S_3 = 11.85$ inches puts arms 3 and 4 in separate sectors.

The calculated k_{eff} for this system, using the diameters previously assigned, is $k_{eff} = 0.852 \pm 0.018$.

Example 3 (See Figure 5)

For this example, the column diameter is allowed to vary. Consider first the sector containing arm 1. Only one quadrant is used, so $d_1 = d_2 = 7.25$ inches.

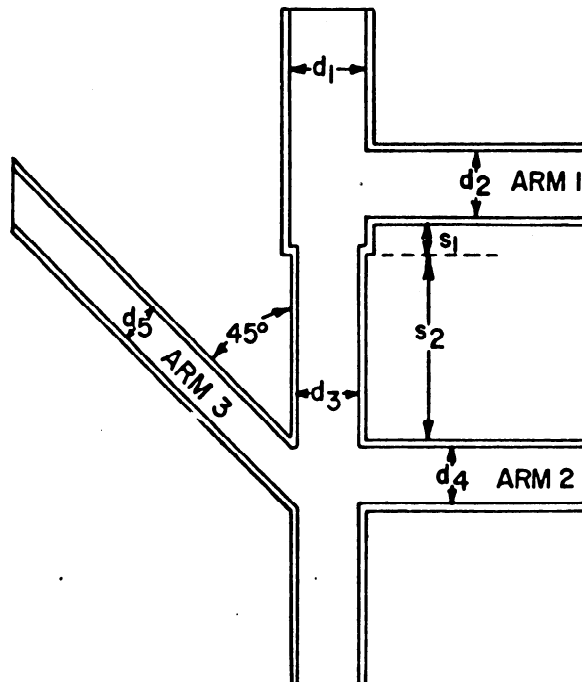

Fig. 5. Pipe system with central column of variable diameter. See Example 3 for calculation of safe dimensions.

Next, the sector containing arms 2 and 3 uses two quadrants, and the maximum column diameter is $d_3 = 7.0$ inches. For the arms, $d_4 = 6.15$ inches and $d_5 = 5.17$ inches (by the same calculations used for arms 1 and 2 of Example 2).

The distance S_2 must be chosen so that the 7.25-inch part of the column cannot be placed in the same sector with arms 2 and 3. This is prevented by setting $S = 18$ inches. There is no restriction on S_1 , since the choice of S_2 is sufficient to put arm 1 in a separate sector from the one containing arms 2 and 3.

To check the conservatism of the GAI model, two O5R calculations were made for this example. With all diameters and spacings as calculated, and with $S_1 \approx 0.2$ inches, $k_{\text{eff}} = 0.833 \pm 0.017$. For $S_1 \approx 18$ inches, $k_{\text{eff}} = 0.821 \pm 0.016$.

Comparison of GEC and GAI Models

A different model for evaluating the safety of pipe intersections for fissile solution was described in RFP-1499.⁽²⁹⁾ This model, called the Generalized Equivalent Cylinder (GEC) model, is based on the idea of replacing an intersection by an equivalent cylinder, whose height and diameter are calculated from the parameters of the intersection. The intersection is deemed safe if the equivalent cylinder is sub-critical.

When applied to uranyl nitrate solution, the GAI model generally allows much larger diameters than the GEC model. Exceptions may occur in the case of a quadrant containing several arms, since the GAI model makes the overconservative rule that the total allowable area is to be divided among the various arms (see Example 1, results for arms 1-6).

Suggestions for Use of the Model

The derivation of the GAI model required only properties common to all fissile solutions, such as the reflector savings correction or the fact that k_{eff} is decreased by replacing one pipe by several smaller ones with the same total area of intersection. Hence, the concept of the GAI model can be applied to other fissile solutions (e.g., plutonium, ^{233}U , or low-enrichment uranium) if calculations or experiments are performed to provide the appropriate numerical values for column diameter and intersection area as given in Table II for uranyl nitrate. The rules of the model are exactly as given here.

Recent French experiments⁽¹⁷⁾ indicate that the GAI model, using the data given in Table II for uranyl nitrate, would be even more conservative when applied to certain bare plutonium solution systems. In particular, plutonium nitrate solution (3.13% ^{240}Pu , acidity about 2N, concentration > 82 g/liter of ^{239}Pu) is found to be less reactive than uranyl nitrate (90% ^{235}U , acidity about 2N) for the same concentration of the fissile isotope.

A second possible variation of the GAI model concerns the particular column diameters and corresponding intersection areas given in Table II. If, for example, one did not need column diameters as large as those given in Table II but needed instead larger intersection areas, one could make such modifications if appropriate calculations or experiments were performed to support these changes, but the basic assumptions of the GAI model would still apply.

The referenced article⁽²⁶⁾ suggests that, whenever possible, proposed pipe systems for fissile solution be evaluated using both the GEC⁽²⁹⁾ and the GAI models. Since both models are adequately conservative, one can choose the model that gives the better result in each particular case.

c. Other Computational Methods

Monte Carlo calculational codes are now used extensively for calculating safe neutron interaction between arrays of fissile subcritical units or piping intersections as illustrated in the previous section. For unique piping problems that cannot be easily estimated with the GAI model or for less conservative results, the GEM⁴, MONK, KENO, or other suitable Monte Carlo codes may be used.

2. Array Calculation - Solid Angle Method

In the case of small numbers of units at large separation distances, the solid angle method may be used to determine a conservative safe array. The solid angle method is quite tedious for large arrays even if the units are identical. In this method the total fractional solid angle of all surrounding units seen by the most reactive unit, usually the most centrally located, the k-effective of the central unit when isolated, and the probability of neutrons escaping the units are used to determine the k-effective of the array.

The solid angle, Ω (in steradians), or fractional solid angle, Ω_f , which is $\Omega/4\pi$, for cylinders and slabs may be calculated by the equations:

FORMULAE

General

$$\Omega = \frac{\text{cross-sectional area}}{(\text{separation distance})^2}$$

Pipes

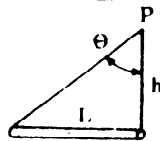

$$\Omega = (l/h) \sin \theta$$

Discs

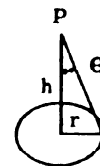

$$\Omega = 2\pi (1 - \cos \theta)$$

Planes

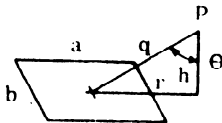

$$\Omega = (ab/q^2) \cos \theta$$

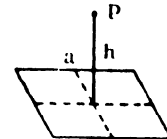

$$\Omega = 4 \sin^{-1} \frac{(a/2)(b/2)}{\sqrt{(a/2)^2 + h^2} \sqrt{(b/2)^2 + h^2}}$$

APPLIED METHODS

Cylinders

(Reduce to planes center-to-edge)

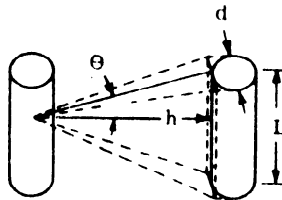

$$\Omega = (2d/h) \sin \theta$$

Spheres

(Reduce to discs center-to-edge)

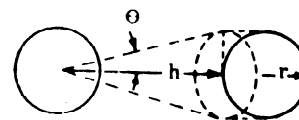

$$\Omega = 2\pi (1 - \cos \theta)$$

The fractional solid angle between identical spheres, slabs and cylinders may also be obtained from curves (pp. V.D.1-1, -2, -3) taken from Reference 3. However, an examination of the data in Table IV indicates nonconservative results when these curves are used with less than a separation of 2 diameters between units. The solid angle calculated by the use of equation (b) gives conservative answers.

The following equation⁽³⁾ may be used to calculate the k-effective of regular arrays of identical units:

$$k_a = \frac{k_u}{1 - [(1-U) \sum (q_i \Omega_{fi})]} \quad (d)$$

where

(1-U) is the probability that fission neutrons will escape before being thermalized.

Ω_f is the fractional solid angle subtended at the central-most unit by the i-th unit of the array.

q_i is the flux weighting factor for the i-th unit of the array. For identical cylinders in air, $q_i = p_i$ where p_i is a weighting factor to Ω_i . For each unit in the array, p is based upon the neutron flux at that point of the array. Formulas for determining p are presented in Table II. For small arrays, a conservative solution may be obtained by considering $p_i = q_i = 1$.

k_a is the k-effective of the array.

k_u is the k-effective of the unit.

TABLE II

(3)

FLUX WEIGHTING FACTORS FOR DIFFERENT ARRAY SHAPES, p

<u>Array Shape</u>	$p = \frac{\phi}{\phi_c}$
1. Sphere	$\frac{\sin(\pi r/R')}{\pi r/R'}$
2. Slab (Flux distribution measures perpendicular to face)	$\cos\left(\frac{\pi z}{2H'}\right)$
3. Slab (Flux distribution measures parallel to face)	$\cos\left(\frac{\pi x}{2W'}\right) \cos\left(\frac{\pi y}{2L'}\right)$
4. Parallelepiped or Cube (For cube $W' = L' = H'$)	$\cos\left(\frac{\pi x}{2W'}\right) \cos\left(\frac{\pi y}{2L'}\right) \cos\left(\frac{\pi z}{2H'}\right)$
5. Infinite Cylinder	$J_0\left(\frac{j_0 r}{R'}\right)$
6. Finite Cylinder	$J_0\left(\frac{j_0 r}{R'}\right) \cos\left(\frac{\pi z}{2H'}\right)$

$$j_0 = 2.405.$$

$$\phi_c = \text{Flux at the center of the array.}$$

$$\phi = \text{Flux at any given point in the array.}$$

For a homogeneous reactor, the primed letters have the conventional meanings of being the actual respective physical dimensions of the reactor plus an extrapolation distance determined by the reactor conditions; for symmetric geometries, all measurements are made from the geometric center of the reactor, which is also the point of greatest flux. For the analogous multi-unit arrays as described, these primed letters also represent the physical dimensions of the array, where these physical dimensions are considered as being bounded by the centers of the outer-most units, plus an "extrapolation length" which, for single-tier square arrays, is equal to one center-to-center spacing of the units in the array; all measurements are also made from the geometric center of the array.

When material bucklings, migration areas and k_{∞} are available for the material in a regular array of identical units, the following equations may be used to calculate k_a :

$$k_u = \frac{1 + M^2 B_m^2}{1 + M^2 B_g^2} \quad (e)$$

$$1-U, \text{ the leakage probability} = \frac{M^2 B_g^2}{1 + M^2 B_g^2} \quad (f)$$

Substituting (e) and (f) into equation (d):

$$k_a = \frac{\frac{1 + M^2 B_m^2}{1 + M^2 B_g^2}}{1 - \frac{M^2 B_g^2}{1 + M^2 B_g^2} \sum (q_i \Omega_{fi})} \quad (g)$$

$$k_a = \frac{1 + M^2 B_m^2}{1 + M^2 B_g^2 \left[1 - \sum (q_i \Omega_{fi}) \right]} \quad \text{or} \quad (g)$$

$$= \frac{k_{\infty}}{1 + M^2 B_g^2 \left[1 - \sum (q_i \Omega_{fi}) \right]}$$

If k_u is known:

$$k_a = \frac{k_u}{1 - \left[\frac{M^2 B_g^2 \sum (q_i \Omega_{fi})}{1 + M^2 B_g^2} \right]} \quad (h)$$

Example of Solid Angle Method and Correlation with Experiment

Problem: An array of 25 identical cylinders of 92.6 Wt% ^{235}U as uranyl nitrate at a concentration of 410 g U/l, the cylinders are polyethylene bottles 13.6525 cm O.D., 112.4 cm high, and average wall thickness of 0.63 cm. At critical the bottles are equally spaced at 11.557 cm surface to surface. Since the cylinders are identical the center-most will have the highest reactivity due to the interaction from all other "seen" cylinders. This was an actual critical experiment performed at Oak Ridge and reported in ORNL-3193, a progress report of the laboratory, in 1961.

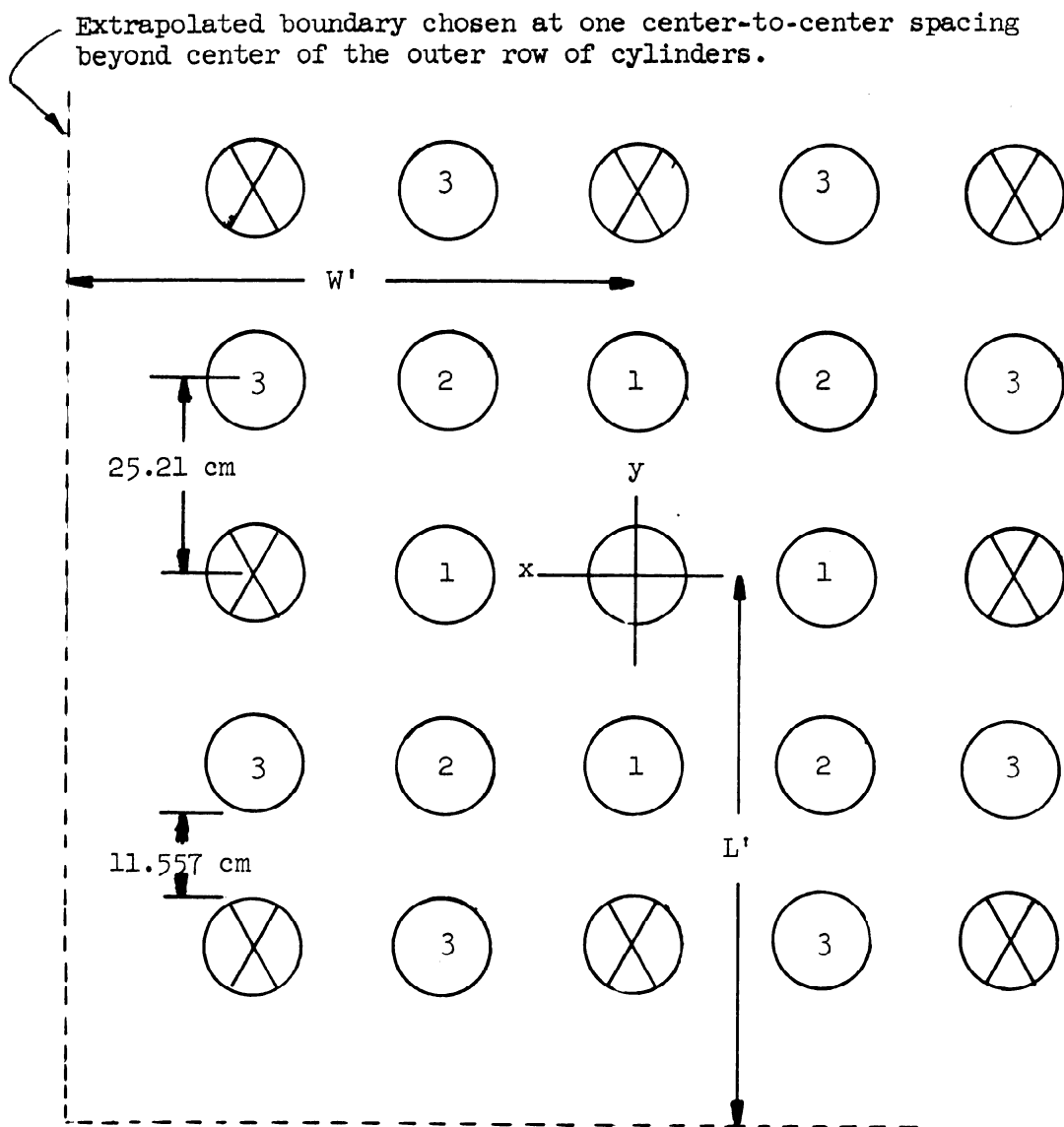

From page III.B.11.93-1 we obtain k_{∞} equal to 1.841 and M^2 equal to 28.7 and from page III.B.10.93-1 we find the bare extrapolation distance, λ_b , equal to 2.1.

The cylinders crossed out in the sketch, page V.B.2-5, are hidden from the center cylinder and do not interact with it. To obtain the fractional solid angle of each of the symmetry types, the center-to-center distance of each symmetry type from the central cylinder must be calculated.

Using the equation (b), the distance, h , must be obtained and the fractional solid angle calculated. For the closest cylinders to the central cylinder (symmetry one):

$$h = (\text{center-to-center distance}) - (\text{radius of the cylinder}) = 18.384 \text{ cm}$$

Then

$$\Omega_{fi} = \frac{.07962 (13.6525)(112.4)}{18.384 \left[(18.384)^2 + \left(\frac{112.4}{2} \right)^2 \right]^{1/2}} = .1124$$

Since the array is planar and square, equation 3 in Table II may be used to calculate p . And since the array is in air

$$q = p = \cos \frac{\pi}{2} \left(\frac{x}{w'} \right) \cos \frac{\pi}{2} \left(\frac{y}{L'} \right) \quad \text{or}$$

$$q = \cos \frac{\pi}{2} \left(\frac{1}{3} \right) \cos \frac{\pi}{2} (0)$$

$$= 0.866$$

Since there are four cylinders of this symmetry, $\sum \Omega_{fi} q_i$ is equal to $4(0.866)(.1124)$ or 0.3893, the total solid angle for cylinders of symmetry one.

The solid angles for the other two symmetries are calculated in the same manner and are included in Table III, page V.B.2-8.

A second method for obtaining the fractional solid angle uses the curves on page V.D.1-2 to obtain values of λ and σ

$$\text{where } \lambda = \frac{L}{d} = \frac{112.4}{13.6525} = 8.23$$

$$\text{and } \sigma = \frac{(\text{center-to-center distance}) - d}{d} = \frac{25.21 - 13.6525}{13.6525} = 0.85$$

Applying these values to Figure V.D.1-3 gives Ω_f equal to 0.08.

The total solid angle for the four symmetry one cylinders, $\sum \Omega_{fi} q_i$, is then equal to $4(.866)(.08)$ or .277. The solid angle for the other symmetries are shown in Table III (p. V.B.2-8), which compares the solid angles calculated using equation (a) and using Figure V.D.1-3.

To calculate the k_{eff} of the array using equation (g), the geometric buckling, B_g^2 , of a single unit must be calculated.

To calculate B_g^2 for one cylinder:

$$\begin{aligned} B_g^2 &= \frac{J_0^2}{(R_{cy} + \lambda)^2} + \frac{\pi^2}{(H_{cy} + 2\lambda)^2} = \frac{5.784}{(6.8265 + 2.1)^2} + \frac{9.87}{(112.4 + 5.47)^2} \\ &= .073298 \text{ cm}^{-2} \end{aligned}$$

Note: Since the wall thickness of the polyethylene bottles varies, the outside dimension is used to allow for reflector savings. Reflector savings of 1.27 cm are added to the axial extrapolation distance.

Calculate k_a using equation (g):

$$\begin{aligned} k_a &= \frac{k_\infty}{1 + M^2 B_g^2 \left[1 - \sum (q_i \Omega_{fi}) \right]} \\ &= \frac{1.841}{1 + (28.7)(.073298)(1 - .704)} \\ &= 1.1345 \end{aligned}$$

This is compared to the experimental k_a of 1.000 giving a conservative result. If the total solid angle obtained by using Figure V.D.1-3 is used, the k of the array would be 0.9132, a nonconservative result. The results of the solid angle calculations of other arrays in this experiment are shown in Table IV (p. V.B.2-8). An examination of these results show that the solid angles obtained by the curves of Figure V.D.1-3 are nonconservative when used for close arrays as in this experiment, while the solid angle calculated using equation (b) yields a quite conservative, but safe, result. Therefore, use of the curves in Figures V.D.1-1, -2, and -3 should be limited to estimations of arrays of units that are separated by about two diameters or more.

Table IV also includes the k_{eff} calculated by computer codes Interset⁽⁴⁾ and GEM-III,⁽¹⁵⁾ and the calculated critical number of containers using the density analogue method for some of these arrays. Density analogue also yields nonconservative results for this array of tall, small diameter cylinders. Note also that Interset gives very nonconservative results.

TABLE III

Total Fractional Solid Angle Data for 5X5 Array
of 12.76 liter Bottles of U(92.6)NH

<u>Symmetry</u>	<u>No. of Units</u>	<u>Cylinder Separation, cm</u>		<u>h</u>	<u>λ</u>	<u>σ</u>	<u>q</u>	<u>Ω_f</u>		<u>$(q \Omega_f)$</u>		
		<u>Center to Center</u>	<u>Edge to Edge</u>					<u>$E_q(b)$</u>	<u>Figure V.D.1-3</u>	<u>$E_q(b)$</u>	<u>Figure V.D.1-3</u>	
1	4	25.21	11.56	18.384	8.23	0.85	.866	.112	.08	.389	.277	
2	4	35.65	22.0	28.824	8.23	1.61	.750	.067	.05	.201	.150	
3	8	56.37	42.72	49.544	8.23	3.13	.433	.033	.026	.114	.090	
										$\sum(q_i \Omega_{f_i})$.704	.517

TABLE IV

Comparison of Array Calculation Methods for 410 g U/l, U(92.6)NH Solution
in 5.375" O.D., 12.76 Liter Polyethylene Bottles

<u>Square Arrays</u>		<u>Solid Angle</u>						<u>Density Analogue Number**</u>
<u>Array</u>	<u>Number*</u>	<u>$\sum(q_i \Omega_{f_i})$</u>		<u>k_a</u>		<u>Interset k_{eff}</u>	<u>GEM-III k_{eff}</u>	
		<u>Charts</u>	<u>Eq(a)</u>	<u>Charts</u>	<u>Eq(a)</u>			
3 x 3	9	.4934	.755	.8911	1.2148	0.8787	.9883	8.5
5 x 5	25	.517	.704	.9131	1.1345	0.9209		28.7
6 x 6	36	.4784	.6452	.8777	1.0541	0.9235	.9451	41.7
9 x 9	81	.560	.678	.9560	1.0974	(50 limit)		82.0

* Critical number determined by experiment.

** Number of units calculated to be critical by this method.

3. Array Calculation - Density Analogue Method

Another commonly used method for determining the size of cubic arrays of identical subcritical units is called the density analogue method.⁽⁷⁾

Density analogue is based upon the relationship of a bare spherical critical mass, $M_{c,b}$, and the density of the fissile material, ρ , or:

$$M_{c,b} \propto (\rho)^{-2} \quad (a)$$

$$\frac{M_{c,b}}{M_{co,b}} = \left(\frac{\rho}{\rho_0} \right)^{-2} \quad (b)$$

Where $M_{co,b}$ is the bare spherical critical mass at a different density, ρ_0 .

Since we usually deal with shapes other than spheres, the exponent, 2, is replaced with "S", that can be no greater than 2. The exponent "S" is a function of the size, shape, and nuclear properties of the fissile material as well as any reflecting material near the system.

We usually deal with large arrays of units where each unit is much less than half of a critical mass. Since the effect of reflection on S is not readily available for most systems, bare arrays are calculated and conservative reflection and interspersed moderation factors are applied to the bare array results. For bare arrays S can be approximated by:

$$S = 2(1-f) \quad (c)$$

where

$$f = \frac{M_{e,b,s}}{M_{c,b}}, \text{ the fraction of the critical bare spherical mass of the unit}$$

$M_{e,b,s}$, the mass of the bare sphere equivalent to the mass in the geometry being studied, may be determined by equating spherical buckling to the buckling of the geometry in question and solving for the sphere radius as:

For a cylinder,

$$\frac{\pi^2}{(R_{sp} + \lambda)^2} = \frac{J_0^2}{(R_{cy} + \lambda)^2} + \frac{\pi^2}{(H_{cy} + 2\lambda)^2} \quad (d)$$

For a cube or parallelepiped,

$$\frac{\pi^2}{(R_{sp} + \lambda)^2} = \frac{\pi^2}{(a + 2\lambda)^2} + \frac{\pi^2}{(b + 2\lambda)^2} + \frac{\pi^2}{(c + 2\lambda)^2} \quad (e)$$

The inverse ratio of densities in equation (b) can become the ratio of the volumes since the masses of fissile material in identical units are equal. Equation (b) then becomes:

$$M_{co,b} = M_{c,b} \left(\frac{V_{cell}}{V_{unit}} \right)^S \quad (f)$$

dividing by M_e , the equivalent mass of the units,

$$N_c = \frac{M_{c,b}}{M_e} \left(\frac{V_{cell}}{V_{unit}} \right)^S \quad (g)$$

where

N_c is the number of units necessary
for a critical bare array.

To obtain the fully reflected array size, the bare array is reduced by the reflection factor found in Figure V.D.1-4. In this figure the array reflection factor varies with the material in the units (i.e., the hydrogen atom to fissile atom ratio). In reality, this factor also varies with unit size, the average fissile material density, and the reflector material and thickness.⁽¹³⁾ For this reason care must be exercised in applying these factors to array calculations other than density analogue. Density analogue calculations of experimental metal and solution arrays have given conservative results when this factor has been used.

Two of the points in Figure V.D.1-4, as shown, have been determined experimentally for small arrays of U-235 metal and uranyl nitrate solutions of an H/²³⁵U of 59. The curves are extended by calculational data.⁽⁷⁾ A reflection factor of 20 for plutonium metal has been calculated by D. R. Smith of the Los Alamos Scientific Laboratory. The plutonium reflection factor curve is based upon the Pu/U metal ratio (20/13) and extended to other H/X ratios. This is probably overly conservative for the higher H/Pu ratios.

Example of Density Analogue Correlation

Calculate an experimental square pitch cubic critical array of 64 right-circular cylinders of uranyl (92.6 Wt% U-235) nitrate solution (415 g U/l), sp.gr. 1.555.⁽⁸⁾

Containers: Lucite, 20.32 cm O.D. and 18.84* cm outside height, wall thickness 0.64 cm. Surface-to-surface separation of units at critical was 10.67 cm.

*The cylinders were filled to exactly 5.000 liters + 0.5 g sol. giving this calculated solution height. The outside height of the containers was actually 19.05 cm.

From page III.B.10(93)-1 the material buckling of 415 g U/l UNH is 0.03020 cm^{-2} and the bare extrapolation distance λ_b , is 2.11 cm. The critical, bare, spherical mass at this concentration is calculated from this data.

$$R_{sp} = \sqrt{\frac{\pi^2}{B_g^2}} - \lambda_b = \frac{3.1416}{0.1738} - 2.11 = 15.97 \text{ cm}$$

$$\text{Vol.}_{sp} = 0.004189 (15.97)^3 = 17.062 \text{ liters}$$

$$M_{c,b} = (17.062)(415 \text{ g U/l})(0.926) = 6,557 \text{ g }^{235}\text{U}$$

$$M_e = \text{mass of unit} = (5)(384.38 \text{ }^{235}\text{U/l}) = 1,921 \text{ g }^{235}\text{U}$$

$M_{e,b,s}$, the mass of a bare sphere equivalent to the mass in the shape being considered may be determined by equating spherical buckling to the shape buckling as:

$$\frac{\pi^2}{(R_{sp} + \lambda)^2} = \frac{J_0^2}{(R_{cy} + \lambda)^2} + \frac{\pi^2}{(H_{cy} + 2\lambda)^2} \quad \begin{array}{l} \text{all dimensions} \\ \text{are in cm.} \end{array}$$

For this experiment,

$$R_{cy} = 9.52 \text{ cm}$$

$$H_{cy} = 17.561 \text{ cm}$$

$$\lambda_b = 2.11 \quad \text{However, the 0.64 cm wall increased the extrapolation length by approximately 0.8 cm (see page II.E-5). Reference IA-3612 indicates plexiglas <1.0 cm is equivalent to polyethylene.}$$

$$\therefore \lambda = 2.11 + 0.8 = 2.91$$

$$\begin{aligned} \frac{9.87}{(R_{sp} + 2.91)^2} &= \frac{5.784}{(9.52 + 2.91)^2} + \frac{9.87}{(17.561 + 5.82)^2} \\ &= \frac{5.784}{154.5} + \frac{9.87}{546.7} = .037436 + .018054 = .055491 \end{aligned}$$

$$R_{sp} = \frac{\pi}{\sqrt{.05549}} - \lambda = 13.336 - 2.91 = 10.426 \text{ cm}$$

$$V_{sp} = (.004189)(10.426)^3 = 4.748 \text{ liters}$$

$$M_{e,b,s} = (4.748)(384.3) = 1,824 \text{ g }^{235}\text{U}$$

and

$$S = 2 \left(1 - \frac{1824}{6557} \right) = 1.433$$

$$V_{\text{cell}} = (10.67 + 20.32)^2(10.67 + 19.05) 10^{-3} = 28.542 \text{ liters}$$

$$V_{\text{unit}} = 5.0 \text{ liters}$$

$$\begin{aligned}
 N_c &= \frac{M_{c,b}}{M_e} \left(\frac{V_{cell}}{V_{unit}} \right)^S \\
 &= \frac{6557}{1921} \left(\frac{28.542}{5.0} \right)^{1.443} \\
 &= 3.413 (12.3495) \\
 &= 42
 \end{aligned}$$

Or compared to the actual critical number of 64, density analogue is conservative by 35 percent. A comparison of experiment with the density analogue method gave the numbers (Table V) for other bare critical arrays of the same containers and materials as used in the example.

TABLE V

Five Liter U(92.6)NH Equilateral Cylinder Arrays (8)

<u>Cubic Array</u>	<u>Surface-to-Surface, cm</u>	<u>Number of Units Experiment</u>	<u>Critical Calculated</u>	<u>GEM-III K_{eff}</u>
2 x 2 x 2	1.43	8	8.9	
3 x 3 x 3	6.48	27	23	
4 x 4 x 4	10.67	64	42	0.953
5 x 5 x 5	14.40	125	69	

Note that the 2 x 2 x 2, close array is nonconservative as well as the GEM-III calculations on the 4 x 4 x 4 array.

The density analogue method was also used to calculate the close packed, long U(92.6)NH bottle experiment used in the solid angle example (see Table IV and Table VI, pages V.B.2-8 and V.B.3-5).

Density analogue appears to be nonconservative for single tier arrays of long bottles, but when the bottles are stacked and the array more closely approaches a cube, the results are conservative. This may be better shown in Figure V.D.1-5, where it appears that the density analogue method is conservative when the bottles are stacked two or more tiers high or for a large single tier where their surface-to-surface spacing is greater than 8 inches. Care must be exercised when using this method to calculate safe tall cylinder arrays.

TABLE VI

Density Analogue Results for 410 g U/l, U(92.6)NH
in 5.375" O.D., 12.76 Liter Bottles (9)

<u>Single Tier</u> <u>Square Array</u>	<u>Surface-to-</u> <u>Surface, in.</u>	<u>Number of Units</u> <u>Experiment</u>	<u>Critical</u> <u>Calculated</u>	<u>GEM-III</u> <u>K_{eff}</u>
3 x 3	1.75	9	8.5	.9883
4 x 4	3.32	16	17.6	
5 x 5	4.55	25	28.7	
6 x 6	5.64	36	41.7	.9451
9 x 9	7.79	81	82	
<u>Double Tier</u>				
4 x 4	3.72	32	21	
5 x 5	5.35	50	38	
7 x 7	8.33	98	91	

Density analogue has been used quite extensively in calculating metal arrays. An example follows of the plutonium ingot array experiments carried out at the Lawrence Radiation Laboratory. (10)(11)

Data: A cubic array of 64 (4x4x4), 3.026 kg (19.6 g/cm³) of 6.5 cm diameter and 4.6 cm high, with center-to-center horizontal spacing (x and y) of 12.513 cm and vertical spacing (z) of 7.858 cm, was critical. The bare spherical critical mass of plutonium is taken as 10.2 kilograms.

To obtain the buckling conversion from the cylinders to spheres, the bare extrapolation distance of plutonium metal is needed. This was obtained from DP-532 (12) pages 207 and 219 as 1.582 cm.

The buckling conversion is then

$$\begin{aligned} \frac{\pi^2}{(R_{sp} + \lambda_b)^2} &= \frac{J_0^2}{(R_{cy} + \lambda_b)^2} + \frac{\pi^2}{(H_{cy} + 2\lambda_b)^2} \\ R_{sp} &= \left[\frac{\pi}{\frac{J_0^2}{(R_{cy} + \lambda_b)^2} + \frac{\pi^2}{(H_{cy} + 2\lambda_b)^2}} \right]^{1/2} - \lambda_b \\ &= \left[\frac{\pi}{\frac{5.784}{(3.25 + 1.582)^2} + \frac{9.87}{(4.6 + 3.164)^2}} \right]^{1/2} - 1.582 \\ &= 3.3156 \text{ cm} \end{aligned}$$

$$\begin{aligned} \text{Vol}_{\text{sp}} &= 4.189(3.3156)^3 = \text{Vol}_{\text{unit}} \\ M_e &= 152.69(19.6 \text{ g/cm}^3) = 2992.7 \text{ g Pu} \\ S &= 2 \left(1 - \frac{2992.7}{10,200} \right) = 1.413 \\ \text{Vol}_{\text{cell}} &= (12.513)^3(7.858) = 1230.37 \text{ cm}^3 \\ N_c &= \frac{10.2}{2.9927} \left(\frac{1230.4}{152.7} \right)^{1.413} = 65 \end{aligned}$$

The result is slightly nonconservative by 1.6 percent. If no buckling conversion is made, the density analogue method gives a conservative result of 62.5 units critical.

The density analogue method can be used equally well for uranium metal arrays. Table VII lists some of the uranium and plutonium metal arrays calculated by density analogue. Each array was calculated by using the buckling conversion and also by using the shape allowance factor obtained from page II.B.4-1. The arrays were also calculated without applying a geometry correction. The uncorrected calculations yielded conservative results in all cases, 18 to 44 percent lower than the actual arrays of metal cylinders. However, for the plutonium arrays the calculated results were within 1.5 percent of the experimental numbers. Use of the shape allowance factors yielded nonconservative results in most cases and should not be used with density analogue.

TABLE VII

Density Analogue Calculations of Metal Critical Experiments

Uranium(93.2) Metal of Various Dimensions							
Geometry*	Unit Mass,		Array	Exp. No. Units	Calculated No. Units		
	Kilograms	H/D			Shape Cor.	B _g ² Cor.	Uncorrected
A ⁴	10.487	.948	3 x 3 x 3	27	29	22	22
A ⁴	10.487	.948	4 x 4 x 4	64	68	51	50
A ⁶	10.434	.47	4 x 4 x 4	64	100	61	42
C ³	20.877	.94	3 x 3 x 3	27	21	17	15
B ³	15.683	.70	3 x 3 x 3	27	26	21	18
Plutonium Metal (2.6" dia., 1.8" high in Al cans, 3.026 Kgs Pu)							
S-to-S Separation	H/D		Array	Exp. No. Units	Calculated No. Units		
x,y,z	cm				Shape Cor.	B _g ² Cor.	Uncorrected
x,y,z	0.75	0.7	2 x 2 x 2	8	10	8.0	8
x,y,z	2.95	0.7	3 x 3 x 3	27	36	27.3	27
x,y	12.513	0.7	4 x 4 x 4	64	88	63.9	63
z	7.858						

*See page V.B.4-2 for definition.

4. Other Methods for Calculating Interaction

J. T. Thomas, Oak Ridge Laboratories, has developed a neutron nonleakage fraction parameter for enriched uranium units in cuboidal arrays where experimental data for small arrays of the units in question are available or where comparable units can be interpolated from experimental data. (13) (23) His method yields critical numbers within 5 percent of experimental numbers.

H. K. Clark, by the use of simplifying assumptions, has developed a single, generally conservative method that treats the interaction of a unit as the albedo of its surroundings. (14) The albedo is determined by the neutrons emitted by other units or reflectors.

Other valuable methods for calculating critical numbers of arrays are the Monte Carlo computer codes like GEM-III (15) and KENO, (16) a simplified version of O5R. Both of these codes have been correlated with array experiments and generally are accurate to within 2 percent. GEM does not perform as well on moderated materials but KENO will handle all types. Members of the United Kingdom Atomic Energy Authority are writing a new Monte Carlo code, MONK, in Fortran to replace GEM. Monte Carlo codes will be used extensively for interaction calculations in the future.

The following table lists GEM-III and KENO calculated k_{eff} for critical experimental systems:

TABLE VIII

GEM-III AND KENO CALCULATIONS OF CRITICAL EXPERIMENTS

	k_e
	<u>GEM-III</u> <u>KENO</u>
<u>Plutonium Metal Sphere</u> , 5.6 kg ^{239}Pu (1), 19.6 g/cc, 4.0858 cm radius, 38 cm H_2O reflector	1.004 ± .016
<u>Plutonium Metal Sphere</u> , 4.9 kg ^{239}Pu , 19.72 g/cm, 3.9 cm radius, 20 cm H_2O reflector, $k_e = 0.97$ as calculated by DTF (18)	0.9404
<u>Uranium Metal Sphere</u> , 20.11 kg ^{235}U , 19.19 g/cc, 6.3 cm radius, 20 cm H_2O reflection, $k_e = 0.98$ as calculated by DTF (18)	0.9710

TABLE VIII (continued)

Uranium (93.2) Metal Array Experiments⁽¹⁹⁾

<u>Unit</u>	<u>Mass kg U (93.2)</u>	<u>Diameter cm</u>	<u>Height cm</u>
A ⁴	10.489	9.116	8.641
A ⁶	10.434	11.481	5.382
B ¹	15.692	11.494	8.077
C ²	20.960	11.506	10.765
C ³	20.877	11.484	10.765

Subscripts on the unit designation give array size and spacing is surface-to-surface in cm.

			<u>ke</u>	
			<u>GEM-III</u>	<u>KENO*</u>
<u>A₆₄⁴ 4 x 4 x 4</u>	<u>4.625 spacing, bare</u>		1.016 + .016	
<u>A₆₄⁶ 4 x 4 x 4</u>	<u>3.952 spacing, bare</u>		1.022 + .017	1.007 + .008
<u>A₆₄⁶ 4 x 4 x 4</u>	<u>12.36 spacing, 15.2 cm paraffin refl.</u>		0.981 + .024	
<u>B₈¹ 2 x 2 x 2</u>	<u>7.823 spacing, 15.2 cm paraffin refl.</u>		0.981 + .019	
<u>C²--S¹--P² 2 x 2 x 2</u>	<u>5.169 spacing, C² ingot enclosed in a 5" Sch 40 iron pipe and each unit enclosed in a 15.6 x 15.6 x 14.8 cm box of lucite 0.64 cm thick.</u>		1.009 + .016	
<u>Interacting slabs of U(93.2)O₂F₂ Solutions</u>	<u>79.2 g ²³⁵U/1(20) One 48" x 31.5" x 6" and with a 48" x 31.5" x 3" slab perpen- dicular "T" shape to it but spaced 3.44" away.</u>		0.988 + .005	

*Using 16 group Hansen-Roach cross sections (25).

k_e	
<u>GEM-III</u>	<u>KENO*</u>

TABLE VIII (continued)

Same slabs except two 3" slabs are together making two, 6" slabs both 48" x 16" x 6" in "T" shape and close together (extrapolated from experimental data).	0.946 ± .013	
<u>4 x 4 x 4 bare array of 5 liter U(92.6)O₂(NO₃)₂ solution 415 g U/l⁽⁸⁾ 10.67 cm spacing in lucite containers.</u>	0.953 ± .017	.990 ± .010
<u>6 x 6 x 1 bare array of 12.76 liters U(92.6)O₂(NO₃)₂ solution 410 g U/l⁽⁹⁾ 14.326 cm spacing in 13 l, 5 3/8" O.D. polyethylene bottles.</u>	0.945	
<u>Plutonium Metal Ingot Arrays⁽¹⁰⁾⁽¹¹⁾</u>		
3.026 kgs plutonium in 6.5 cm dia. and 4.6 cm high, in 0.0371 cm thick aluminum cans, supported in aluminum tubes and with aluminum spacers and heat sinks. Polyethylene reflector blocks where used are 20.2 cm thick. In some cases 2 ingots are stacked together giving 6.05 kg.		
<u>8, 3-kg units, 2 x 2 x 2, bare</u>	1.017 ± .015	0.990 ± .007
<u>27, 3-kg units, 3 x 3 x 3, polyethylene close reflection one side</u>	0.987 ± .006	0.969 ± .009
<u>27, 3-kg units, 3 x 3 x 3, bare</u>		1.012 ± .011
<u>64, 3-kg units, 4 x 4 x 4, bare</u>	1.013 ± .019	1.006 ± .011
<u>64, 6-kg units, 4 x 4 x 4, bare</u>	1.008 ± .025	
<u>64, 3-kg units, 4 x 4 x 4, bare, but each unit surrounded with 1" of mock HE</u>	1.043 ± .024	
<u>PuO₂ - Polystyrene and lucite blocks, isolated by 9.4 cm of polyethylene with 20 mil sheets of cadmium on each side.⁽²¹⁾</u>	1.013 ± .015	

*Using 16 group Hansen-Roach cross sections (25).

TABLE VIII (continued)

	k_e	
	<u>GEM-III</u>	<u>KENO*</u>
<u>PuO₂ - Polystyrene Blocks, separated by layers of 1 Wt% boron stainless steel, 6" lucite reflected. Experiment No. 207A.</u> (22)	1.030 ± 030	
<u>Pu Metal Sphere, 5.425 Kgs ²³⁹Pu, 19.74 g/cm³ H₂O refl.</u> (24)		1.005 ± .034

*Using 16 group Hansen-Roach cross sections (25).

REFERENCES

- (1) "Nuclear Safety Guide", TID 7016, 1961.
- (2) H. F. Henry, et al., "Studies in Nuclear Safety", K-1380, 1958.
- (3) H. F. Henry, C. E. Newlon, and J. R. Knight, "Extensions of Neutron Interaction Criteria", K-1478, 1961.
- (4) F. R. Czerniejewski, "Changes in Interset Code", HW-84495 Rev., 1964.
- (5) C. E. Newlon, "Critical Interaction Probabilities of Enriched UF₆ Arrays", KD-1766, 1962.
- (6) J. K. Fox, "A Correlation of Interaction Data with Calculations Using the Geller Model", IDO-17095, 1965.
- (7) H. C. Paxton, "Criticality Control in Operations with Fissile Material", LA-3366, 1966.
- (8) J. T. Thomas, "Critical Three-Dimensional Arrays of Neutron Interacting Units", ORNL-TM-719, 1963.
- (9) L. W. Gilley, D. F. Cronin, J. K. Fox, J. T. Thomas, "Critical Arrays of Neutron-Interacting Units in Neutron Physics Div. Annual Progress Report", ORNL-3193, pg. 159-167, 1961.
- (10) J. R. Morton, G. A. Pierce, L. L. Garoner, C. J. Ball, "Summary Report of Critical Experiments Plutonium Array Studies Phase I", UCRL-50175, 1966.
- (11) G. A. Pierce, J. R. Morton & H. F. Finn, "Transactions of American Nuclear Society", Vol. 11, No. 1, pg. 378, 379, 1968.
- (12) H. K. Clark, "Handbook of Nuclear Safety", DP-532, 1961.
- (13) J. T. Thomas, "Criticality of Large Systems of Subcritical U(93) Components", ORNL-CDC-1, 1967.
- (14) H. K. Clark, "Interaction of Subcritical Components", DP-312, 1958.
- (15) A. J. Roskell and P. J. Hemmings, "The GEM Code", AHSB(S) R105, United Kingdom Atomic Energy Authority, 1967.
- (16) G. E. Whitesides and N. F. Cross, "KENO - A Multigroup Monte Carlo Criticality Program", CTC-5, Oak Ridge National Laboratory, Union Carbide Corp., 1970.
- (17) J. C. Bouly, R. Caizergues, E. Deilgat, M. Houelle, and L. Maubert, "Interaction Neutronique dans l'Air de Recipients Cylindriques Contenant soit des Solutions d'Uranium soit des Solutions de Plutonium", CEA-R-3946, Commissariat a l'Energie Atomique, Direction de la Protection et de la Surete Radiologiques, Service d'Etudes de Criticite, 1970.

REFERENCES
(continued)

- (18) W. H. Roach and D. R. Smith, "Estimates of Maximum Subcritical Dimensions of Single Fissile Metal Units", ORNL-CDC-3, 1967.
- (19) J. T. Thomas, "Critical Three-Dimensional Arrays of Neutron-Interacting Units", ORNL-TM-868, 1964.
- (20) J. K. Fox, L. W. Gilley, "Applied Nuclear Physics Annual Progress Report", pg. 71-83, ORNL-2389, 1957.
- (21) J. D. White and C. R. Richey, "Physics Research Quarterly Report July, August, September 1965", "Neutron Interaction Between Multiplying Media Separated by Various Materials", BNWL-193, 1965.
- (22) R. C. Lloyd, Letter to G. R. Kiel, "Criticality Experiments with Boron Containing Materials", 1966.
- (23) J. T. Thomas, "The Effect of Shape on the Criticality of Arrays", ORNL-CDC-4, 1967.
- (24) W. V. Geer and D. R. Smith, "Measurement of the Critical Mass of a Water Reflected Plutonium Sphere, ANS Transactions", Vol. 11, No. 1, 1968.
- (25) G. E. Hansen and W. H. Roach, "Six and Sixteen Group Cross Sections for Fast and Intermediate Critical Assemblies", LAMS-2543, 1961.
- (26) Deanne Dickinson and C. L. Schuske, "An Empirical Model for Safe Pipe Intersections Containing Fissile Solution", Nuclear Applications and Technology, 1971.
- (27) B. B. Ernst and C. L. Schuske, "Empirical Method for Calculating Pipe Intersections Containing Fissile Solutions", RFP-1197, Rocky Flats Division, The Dow Chemical Company, 1968.
- (28) D. C. Irving, R. M. Freestone, Jr., and F. B. K. Kam, "O5R, A General-Purpose Monte Carlo Neutron Transport Code", ORNL-3622, Union Carbide Corporation, Oak Ridge National Laboratory, 1965.
- (29) Deanne Dickinson, "Calculations for Pipe Intersections Containing Fissile Solution", RFP-1499, Rocky Flats Division, The Dow Chemical Company, 1970.

C. SUMMARY OF RECOMMENDED CALCULATIONAL PROCEDURES

1. Piping Intersections

The GAI model for determining safe piping intersections is a vast improvement and much less restrictive than the method included in The Nuclear Safety Guide (reference 1, page V.B.4-5). Correlations of the GAI model with Monte Carlo calculations have shown it to be a conservative method for estimating safe piping arrangements.

In addition to the above methods, the Monte Carlo codes GEM 4 (reference 15, page V.B.4-5) and KENO (reference 16, page V.B.4-5) may be used for safely calculating piping reactivities in almost any arrangement. Correlations of GEM 4 with the Rocky Flats piping intersection experiments (reference 29, page V.B.4-6) have shown it to calculate k-effective to within two standard deviations of critical.

2. Solid Angle Method

The solid angle method of calculating neutron interaction when performed with equations (b) and (c) yields conservative results. The method is tedious, especially where many difference geometries and spacing are encountered.

The use of Figure V.D.1-3 yielded nonconservative results for long cylinders with close spacing. Therefore, the curves in this figure are not extended below a σ value of 1.0. The equations and Figure V.D.1-3 agree quite well below λ equal to 3.0 and σ equal to 2.0. In order to obtain conservative or safe calculations, it is recommended that equations (b) and (c) be used. For rough estimations of fractional solid angles, Figure V.D.1-3 may be used.

3. Density Analogue Method

The density analogue method can only be used on arrays of identical units. In most critical experiments checked, the method produced conservative results.

Nonconservative results were obtained from the long, close packed bottle arrays. Therefore, this method should be used only on stacked arrays of long slender containers or where the spacing between units in a planar array is greater than two container diameters.

In the plutonium ingot arrays density analogue yielded very close results both when the cylindrical ingots were corrected by geometric buckling conversion or uncorrected; i.e., using the cylindrical volume and mass. Use of the shape allowance factor, page II.B.4-1, yielded nonconservative results on both plutonium and uranium metal calculations and should not be used with density analogue.

In the uranium metal and solution arrays, both the buckling conversion method and calculations using uncorrected cylindrical mass and volume gave quite conservative but safe results. Using the buckling conversion yielded results that were in slightly better agreement with experiment.

4. Other Methods for Calculating Interaction

The most useful tools for accurately determining the interaction of units in a system are the Monte Carlo computer programs which determine the overall system reactivity. The GEM 4 and KENO codes have been extensively correlated with various experiments and have, in general, been found to estimate the reactivity of a system conservatively, although for some solution array experiments the Monte Carlo calculations appear to be nonconservative. Therefore, the user should be well versed in techniques of using these codes before applying them to actual problems.

Thomas^(1,2) has used Monte Carlo calculations extensively to study the effects of various parameters on the reactivity of arrays. Such effects as fissile unit size, shape, composition and location in a storage cell; the cell size, shape and interspersed moderation; the array size and shape; array reflector material, thickness and location have been studied. The critical array size for various uranium cylinders, with respect to array spacing as shown in Figure V.D.1-8, is an example of Thomas' calculations.

Figures V.D.1-6 and 7⁽³⁾ were made from GEM 4 and KENO calculations for plutonium metal spheres in large arrays, the first figure showing the effects of unit size, array reflector, interspersed moderation, and k_{eff} of array size. The calculations in the latter figure show the critical array size of plutonium metal spheres of 2, 3 and 4 Kg reflected by 12 inches of concrete. The calculated arrays have a k_{eff} of $0.98 \pm .02$.

The study by Carter⁽⁴⁾ on the safe storage of underwater arrays is another example of the use of Monte Carlo calculations. See Section V.D.2

¹J. T. Thomas, Uranium Metal Criticality, Monte Carlo Calculations and Nuclear Criticality Safety, Y-CDC-7, Union Carbide Corporation Nuclear Division, 1970

²J. T. Thomas, The Criticality of Cubic Arrays of Fissile Materials, Y-CDC-10, Union Carbide, Corporation Nuclear Division, (to be published).

³K. R. Ridgway, Calculated Critical Arrays of Fissile Materials, ARH-SA-76, Atlantic Richfield Hanford Company, 1970.

⁴R. D. Carter, Safe Fissile Material Spacing in Water, ARH-SA-77, Atlantic Richfield Hanford Company, 1970.

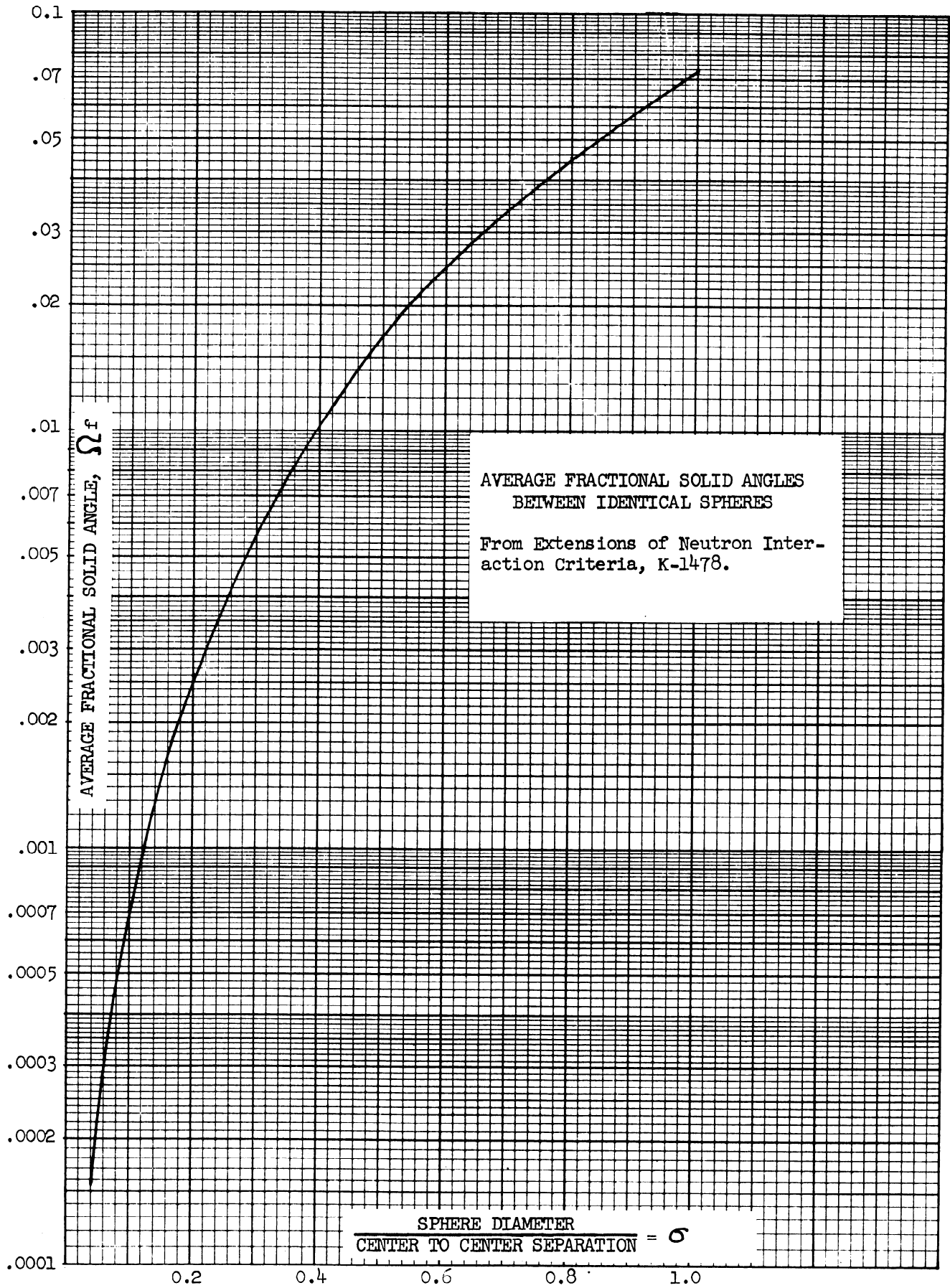

AVERAGE FRACTIONAL SOLID ANGLES BETWEEN IDENTICAL PARALLEL SLABS

From Extensions of Neutron Interaction Criteria, K-1478.

$$\lambda = \frac{\text{Width}}{\text{Edge-To-Edge Separation}}$$

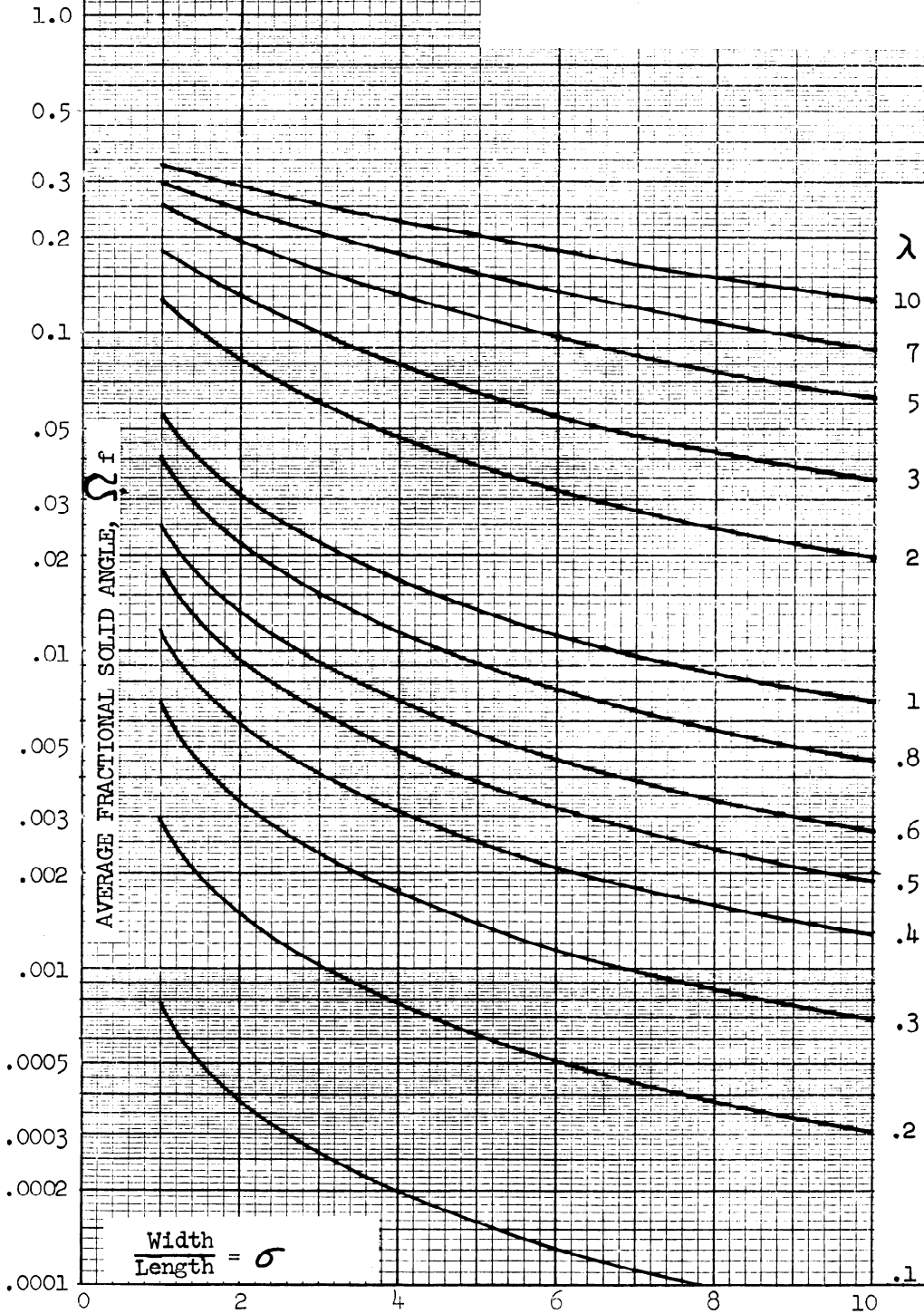

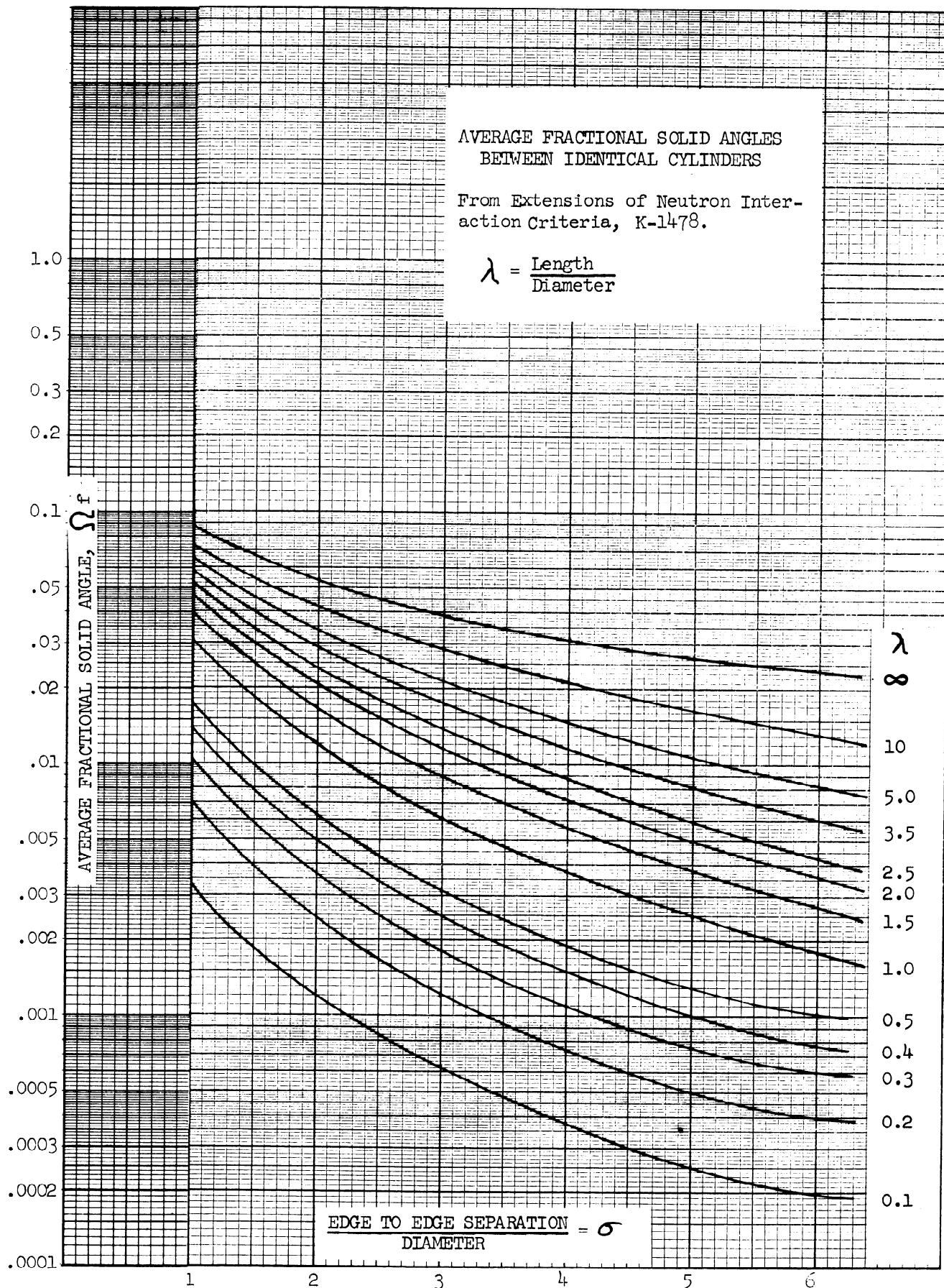

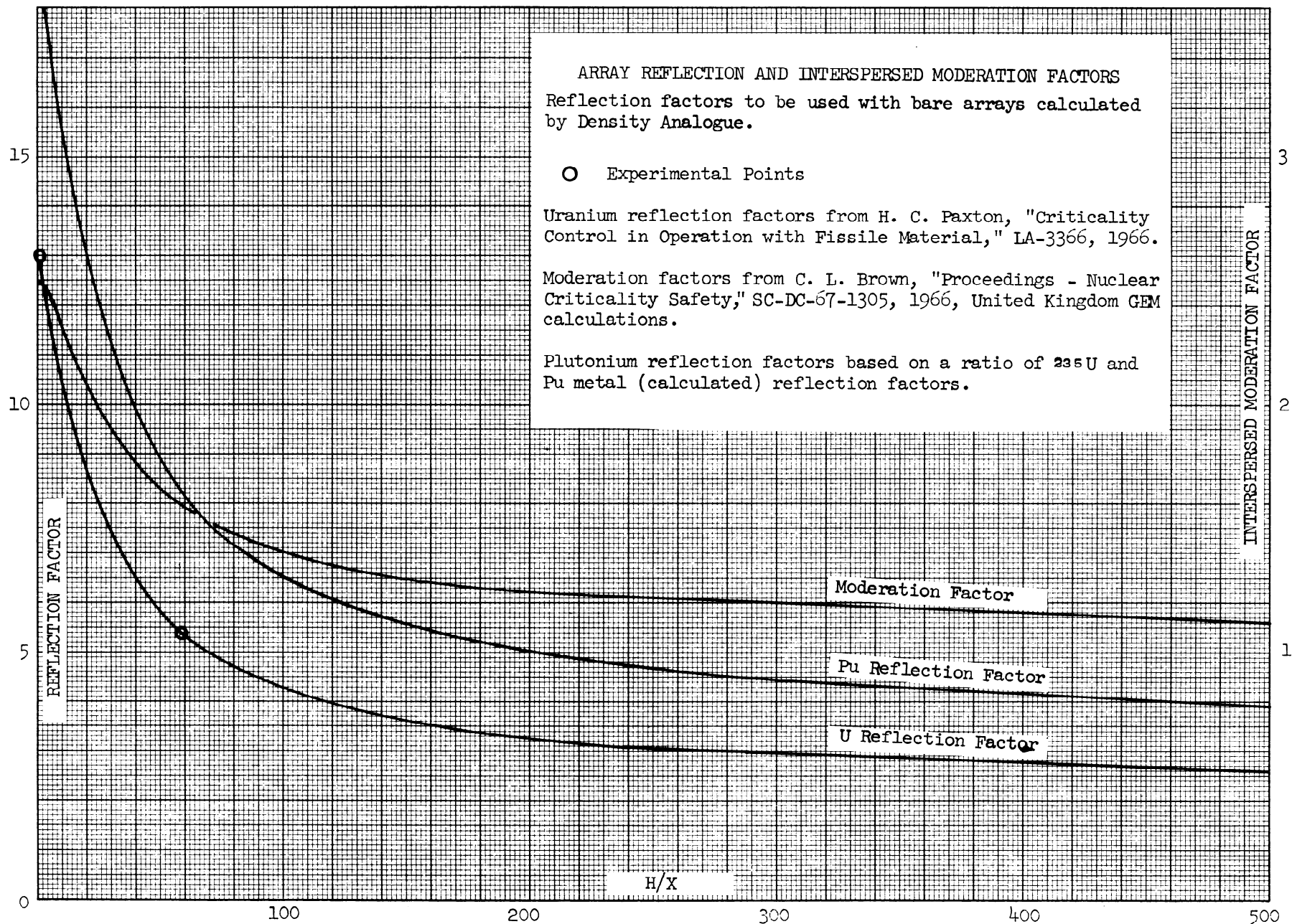

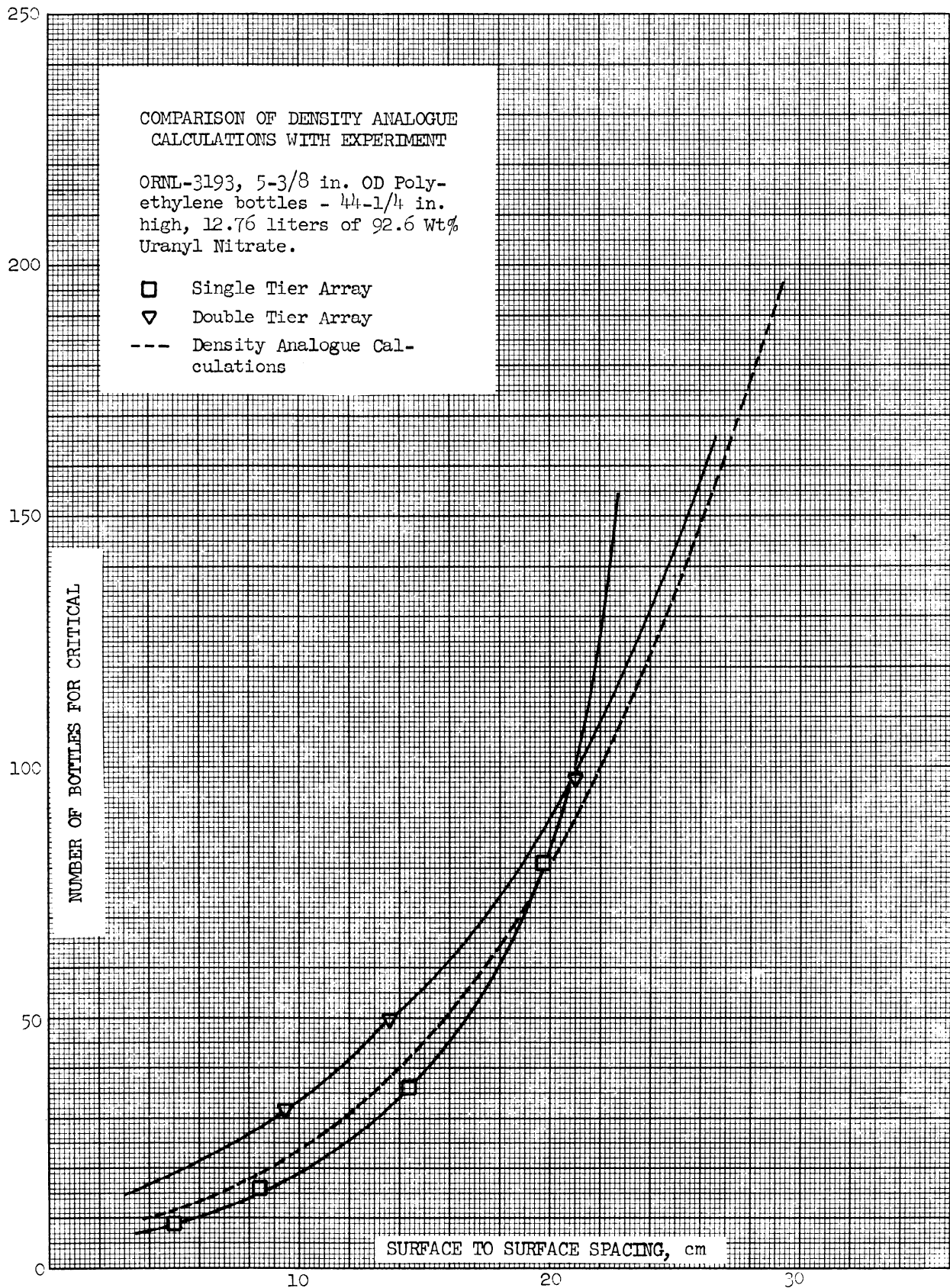

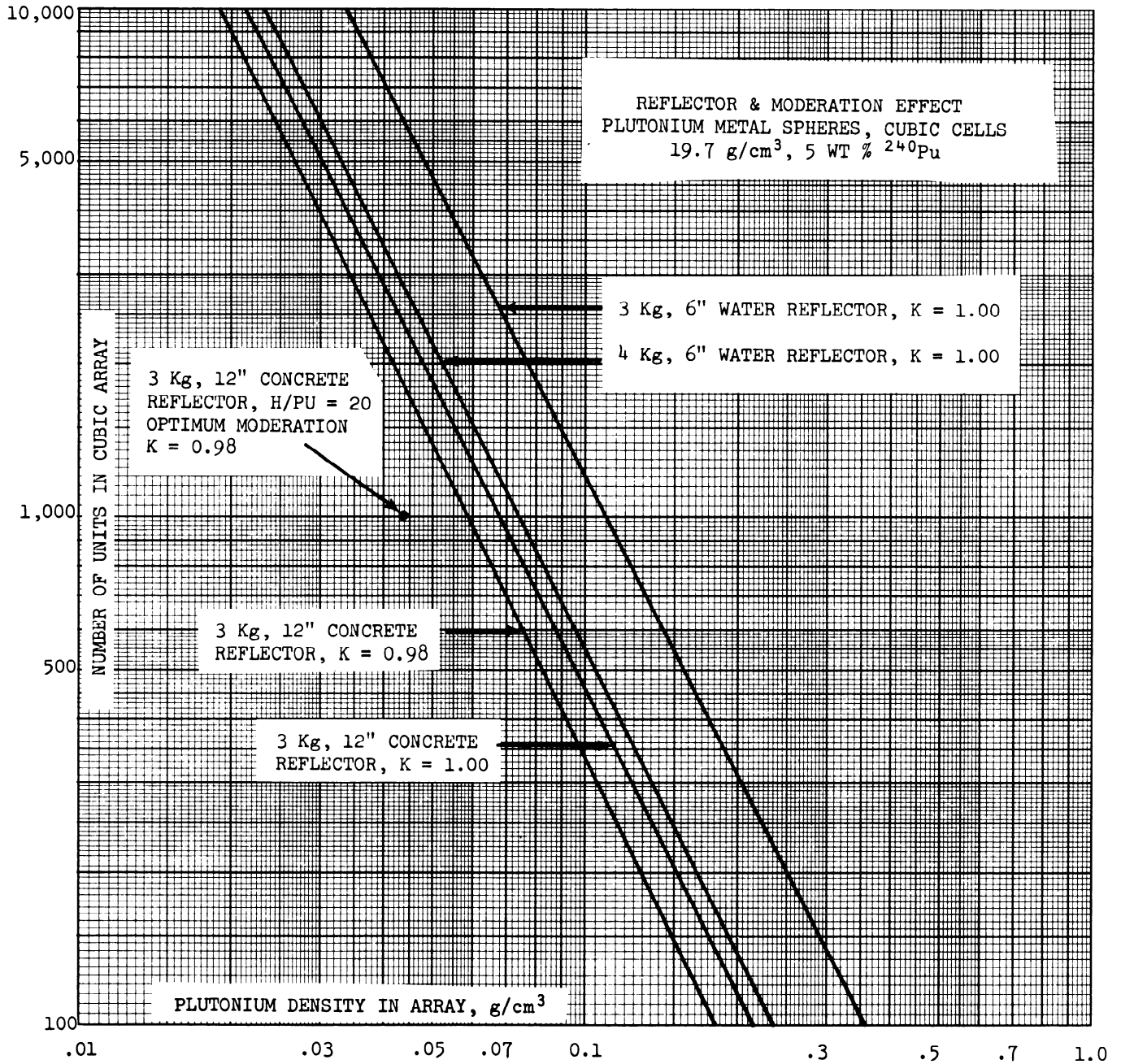

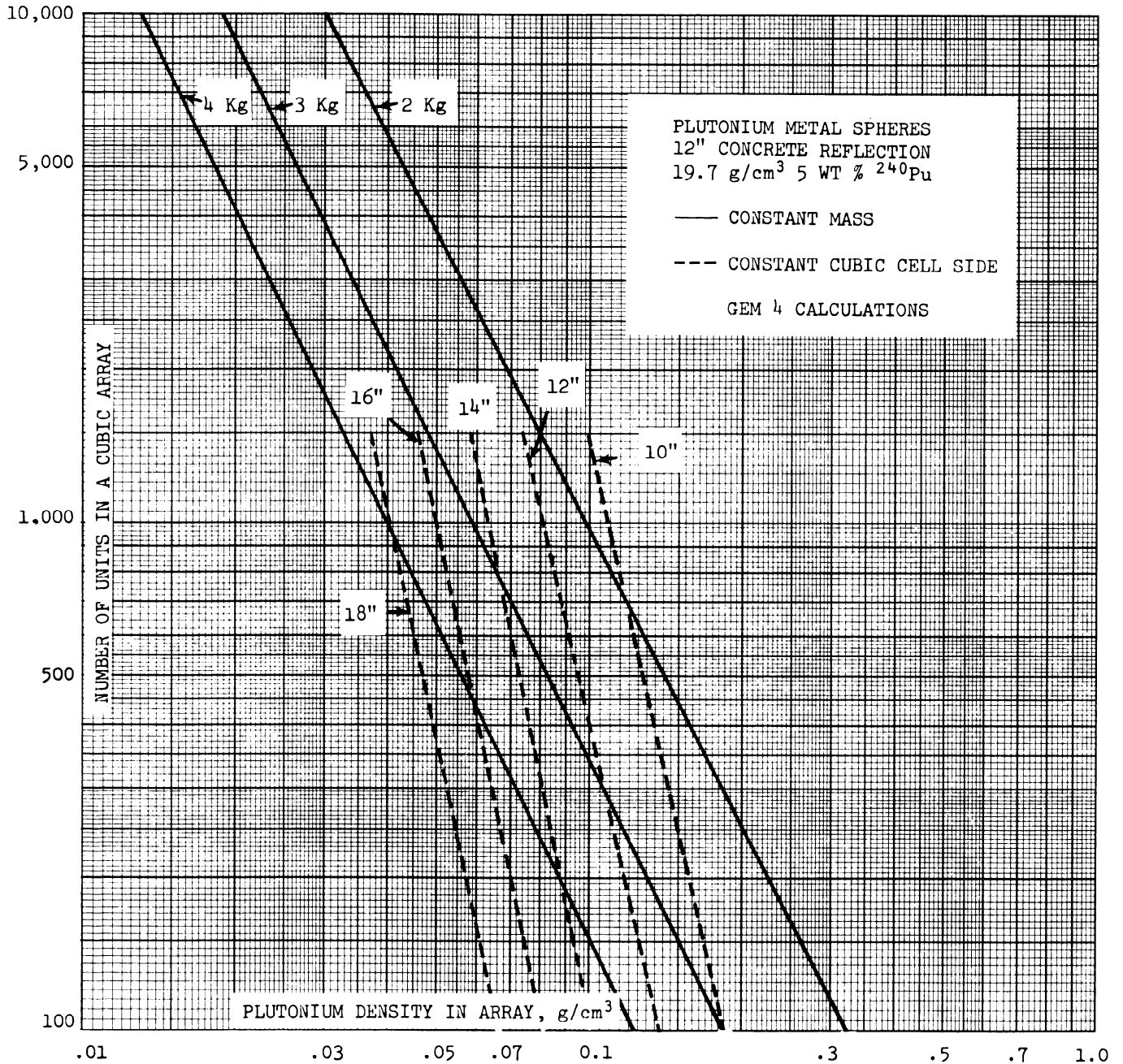

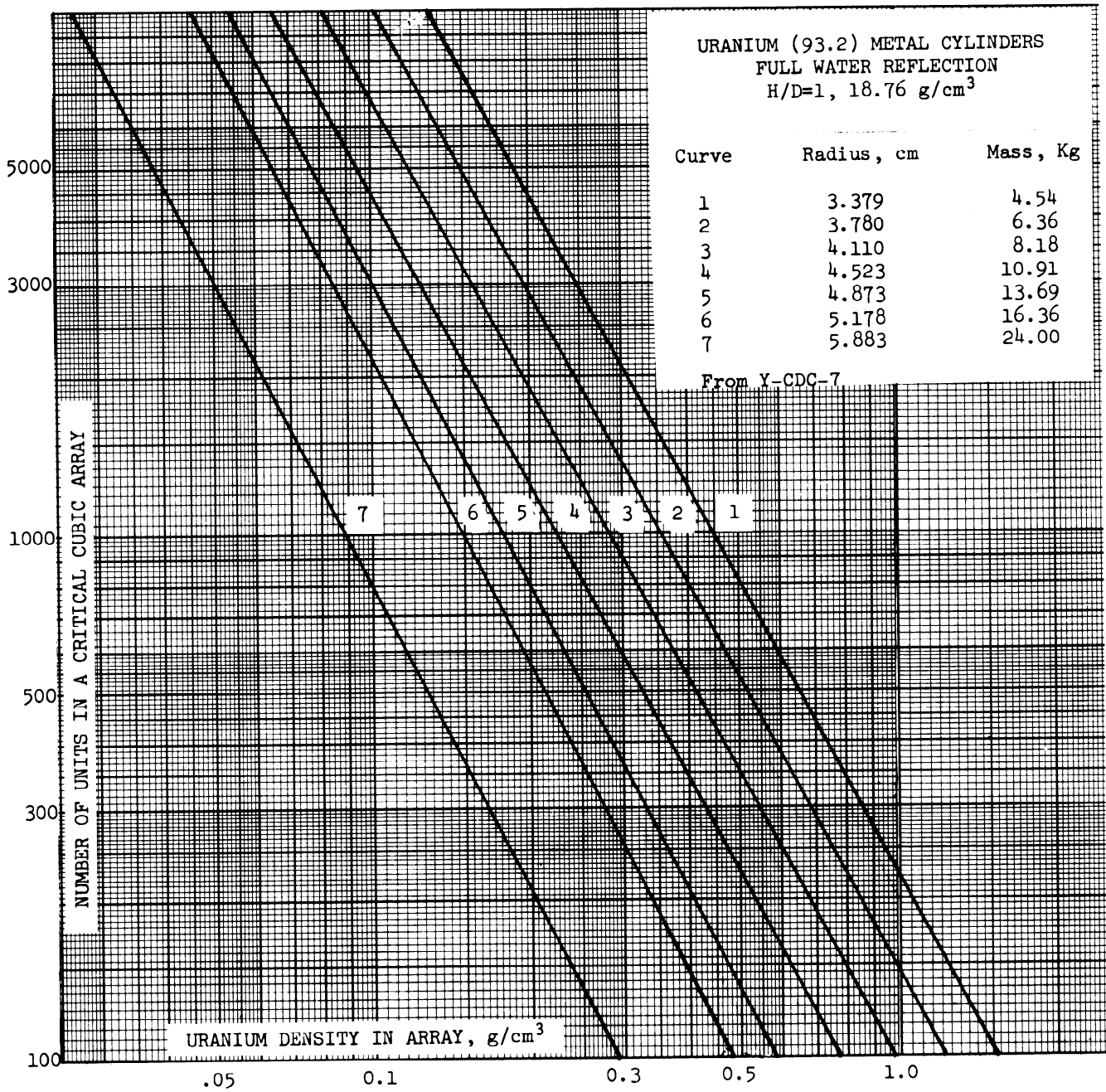

Safe Fissile Material Spacing In Water

A number of infinite arrays of subcritical units in water were studied⁽¹⁾ to determine the change in the array k-effective, k_a , with the change in the water spacing between units. Calculations were made with the DTF4, GEM 4 and KENO codes and with plutonium solution and reactor fuel element units. The data was then used to develop a method of determining a safe spacing with a minimum of computer usage.

The k_a values were determined at various water spacings for a number of representative units. The resulting data was then normalized to 1.0 at zero water spacing (equal to k_∞ for the material of the units) and to 0.0 at infinite water spacing (equal to the isolated unit k-effective, k_u) by the equation $(k_a - k_u)/(k_\infty - k_u)$. A limiting curve was then drawn which encloses all the calculated curves (see graph V.D.2-2) and which permitted the selection of a safe water spacing if k_∞ and k_u are known and a safe value of k_a is selected. Although these safe spacings are not as small as could be determined by a direct calculation they are much less limiting than the spacing required for the complete isolation of each unit and a number of cases may be looked at before selecting a final case for a more definitive calculation.

The limiting curve may be used with a given k_a value to develop a family of curves as shown in V.D.2-3, for more general studies.

It should be recognized that the "limiting curve" is actually applicable only for the types of material studied (e.g., 0.5-inch diameter UO₂ rods moderated to a W/U ratio of 1.0 or greater). Lower W/U values would require shifting the limiting curve to larger water separations. However, the limiting curve shown should be adequate for any normal fuel rod cluster or other moderated fissile unit.

¹R. D. Carter, Safe Fissile Material Spacing In Water, ARH-SA-77, Atlantic Richfield Hanford Company, 1970.

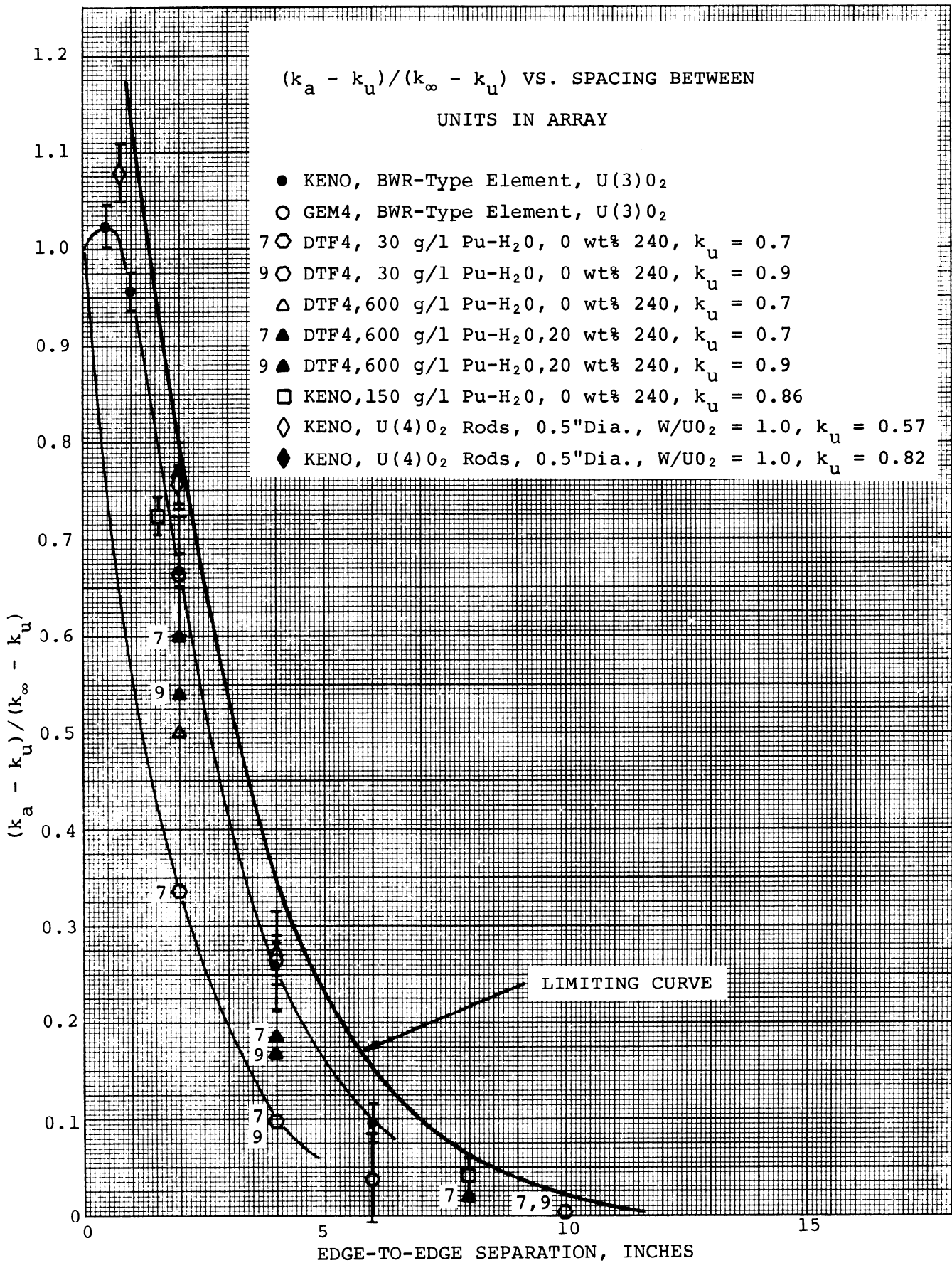

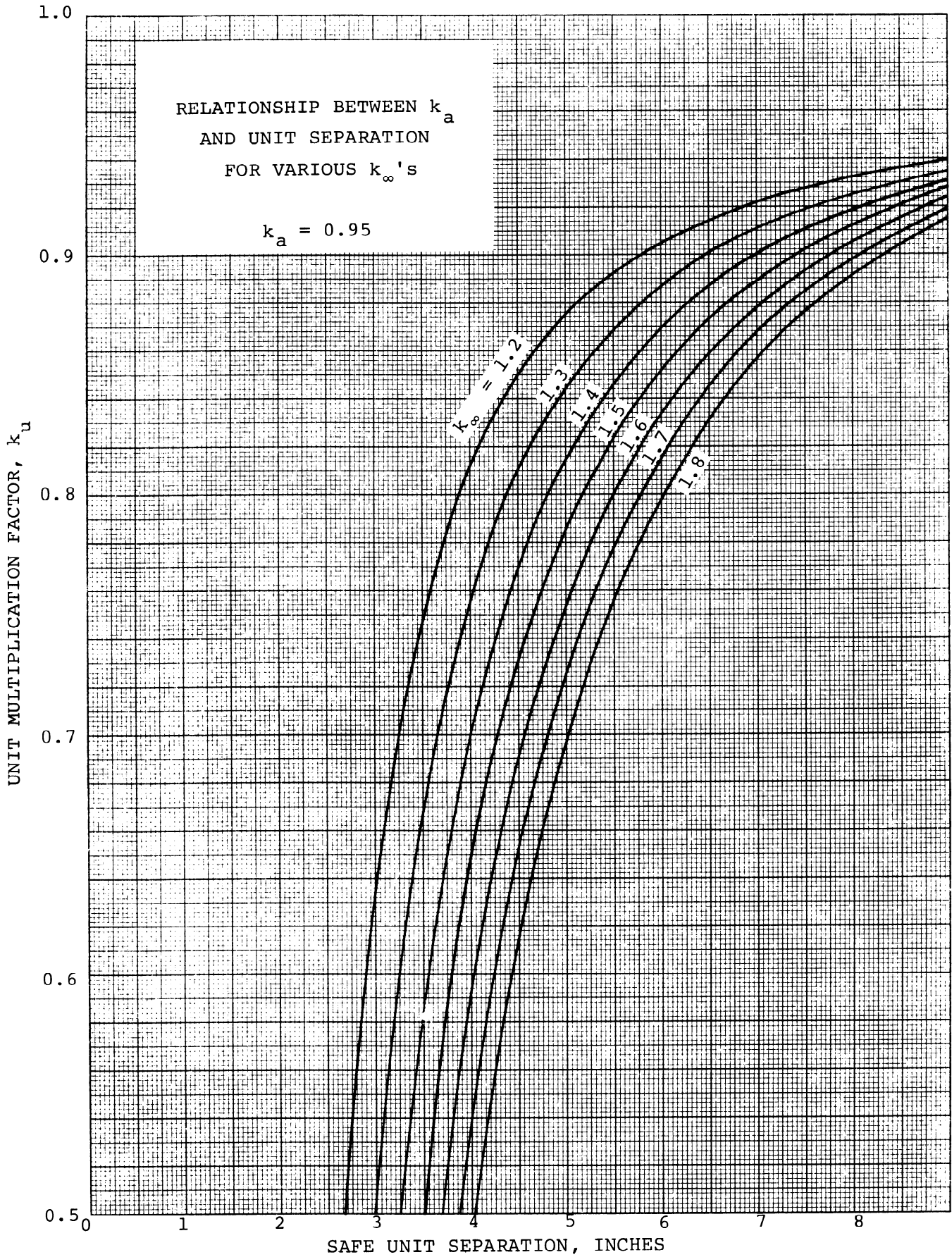

VI. POISONED SYSTEMS

A. HOMOGENEOUS SYSTEMS - SOLUBLE POISONS

1. Plutonium Systems
2. ^{235}U Systems
3. ^{233}U Systems
4. Mixed Systems

B. HOMOGENEOUS SYSTEMS - FIXED POISONS

1. Plutonium Systems
2. ^{235}U Systems
3. ^{233}U Systems
4. Mixed Systems

C. HETEROGENEOUS SYSTEMS - SOLUBLE MODERATOR POISONS

1. Plutonium Systems
2. ^{235}U Systems
3. ^{233}U Systems
4. Mixed Systems

D. REFLECTOR INTERFACES

E. ISOLATORS

VI.1 COMMENTS ON POISONED SYSTEMS

The use of neutron absorbing materials commonly called "poison" materials within fissile systems increases the critical mass by removing from the system a portion of the neutrons available for the fission process. Such poison materials may be added either homogeneously as soluble poisons in solutions or in the moderator of heterogeneous systems or heterogeneously as Raschig rings, plates, etc. Poisoned interfaces between reflectors and fissile cores will generally increase the critical mass or geometry (but putting a poison material around a bare system will decrease the critical mass or geometry because any material will reflect some neutrons - only space is a perfect absorber). Another neutron absorbing device consists of placing neutron absorbers between separate fissile systems to reduce or eliminate neutron interaction between units. Commonly used poison elements are boron and cadmium although simple hydrogenous materials such as water or concrete can be used as isolating medium to eliminate neutron interaction.

The use of poison materials except as isolators has not been extensively practiced. One reason is that experimental data is relatively scarce and, therefore, correlation between calculation and experiment for practical cases is somewhat difficult. For homogeneous systems with homogeneous poisons, it has been generally recommended that poisons be added at twice the concentration calculated for k_{∞} equal to one (the point at which systems of finite size cannot be made critical). However, fairly consistent agreement exists between such widely diverse methods of calculation as diffusion theory, transport theory and Monte Carlo methods (see Figure VI.A.100-1), and it does not seem necessary to always penalize systems of restricted geometry to this extent. (Of course, some of the agreement might well result from all of these calculations using the same cross section sets; a poorly determined cross section set could then result in similar deviations from true values.) We believe a more reasonable approach is to use twice the poison concentration calculated to be necessary to meet general safety criteria.

Some observations on the use of poison materials which may be of value are:

1. It is not necessarily conservative to assume fissile-water systems as the limiting case instead of, say, nitrate systems as is common practice with unpoisoned systems. This can be seen in the graph on page VI.A.100-1, where at high plutonium concentrations more boron is required for the zero molar plutonium nitrate system than for the Pu-H₂O system for identical concentrations. This is a result of the lower H/Pu ratio of the nitrate system. (Had these curves been plotted as a function of the H/Pu ratio instead of concentration the Pu-H₂O system would require more boron at identical H/Pu values.)
2. The use of homogeneous poison must be based on a fail-safe system of poison addition if used as a primary criticality safety control or the required poison concentration must be adjusted to allow for any potential failure of the system.
3. The effectiveness of parallel poison plates at higher concentrations (above 100 g/l) should be considered negligible unless plate spacing is reduced to about one inch or less. Available experimental and calculational data indicate that plate effectiveness is relatively small until a certain critical spacing is reached. Reduction in plate spacing beyond this point increases the critical geometry rapidly (and decreases the fractional free volume of the system).
4. The materials in which solid poisons are incorporated must not dissolve in the environment. For this reason, materials such as stainless-steel-clad Boral should not be used in acid-containing vessels, since breaching of the cladding would permit dissolution of the poison material, but might be allowed in places such as normally dry sumps.
5. The use of poison interfaces between a core and a reflector to increase the core loading or size is a common practice. However, it should be recognized that some materials such as stainless steel, which act as an interface poison with a reflector of water or other hydrogenous material also may be as good a reflector as water if thick enough. This

means that there can be an optimum thickness for a poison interface. Optimum thickness is about 0.25 inch for boron-stainless steel (1 w/o boron). This arises from the fact that slow neutrons are generally more easily absorbed than fast neutrons and that water (hydrogen) both slows neutrons and scatters them while steel mostly scatters. Fast neutrons going through an interface would thus be slowed down in the water and absorbed while returning through the interface to the core. If a steel interface were thick enough, the neutrons would be scattered back before reaching the water, would not be slowed down appreciably and, hence, would not be absorbed in the steel. Loss of poison material due to corrosion of the interface must also be considered in any design.

6. Isolation of fissile systems is generally considered complete by the use of certain material thicknesses, for example, 10 to 12 inches of water or concrete. However, reduction of isolator thicknesses to half or three-fourths of these values may not cause a significant increase in the k -effective of individual fissile units in an array. Significant savings in the use of isolating materials might be achieved if experimental data can be applied to particular cases or if accurate calculational methods are available.

VI.2 CORRELATION WITH EXPERIMENT - HOMOGENEOUS SOLUTIONS

Experimental data for homogeneously poisoned solutions is extremely scarce. Apparently only one set of very limited experiments have been made to date⁽¹⁾. The following table shows the correlation using 18 group cross sections generated by GAMTEC II with the HFN diffusion theory code for critical experiments performed in bare aluminum spheres of 27.24 inches diameter.

<u>Exp. No.</u>	<u>Solution</u>	<u>Fissile g/l</u>	<u>Boron g/l</u>	<u>Calculated k</u>
1	93.18 Wt% ²³⁵ UNH	18.75	0	.9952
2		21.93	.0935	.9959
4		26.51	.230	.9953
5	97.74 Wt% ²³³ UNH	16.75	0	1.0070
7		18.10	.0465	1.0078
9		19.37	.0912	1.0075

Experiments 4 and 9 were calculated with no boron and k values of 1.1338 and 1.0777 respectively. This results in Δk changes of -0.60 and -0.77 for the addition of each gram per liter of boron. The calculations indicate that in experiment 7 the boron compensated for a Δk of 0.0465×0.77 or 0.0358. The Δk between the calculated k-effectives of experiments 5 and 7 is 0.0008. Since this was the worst case, the calculational error is thus a maximum of 2.2 percent (ignoring effects of the experimental error in determining the boron concentration) for this set of data. This accuracy would appear quite acceptable for calculating the effects of boron addition (and, by inference, the addition of other poison isotopes with cross section values of comparable accuracy).

The calculation of reactivities of unpoisoned solutions of greater fissile concentrations has been shown to be reliable. Thus the extrapolation of poisoned solutions critical parameters to higher fissile concentrations should also be reliable. However, the limited range of

the poison experiments requires that a conservative approach be taken to the use of such calculated parameters pending further experimental verification.

-
- (1) R. Gwin and D. W. Magnuson, "The Measurement of Eta and Other Nuclear Properties of ^{233}U and ^{235}U in Critical Aqueous Solutions", Nuclear Science and Engineering, 12: 364-380, 1962.

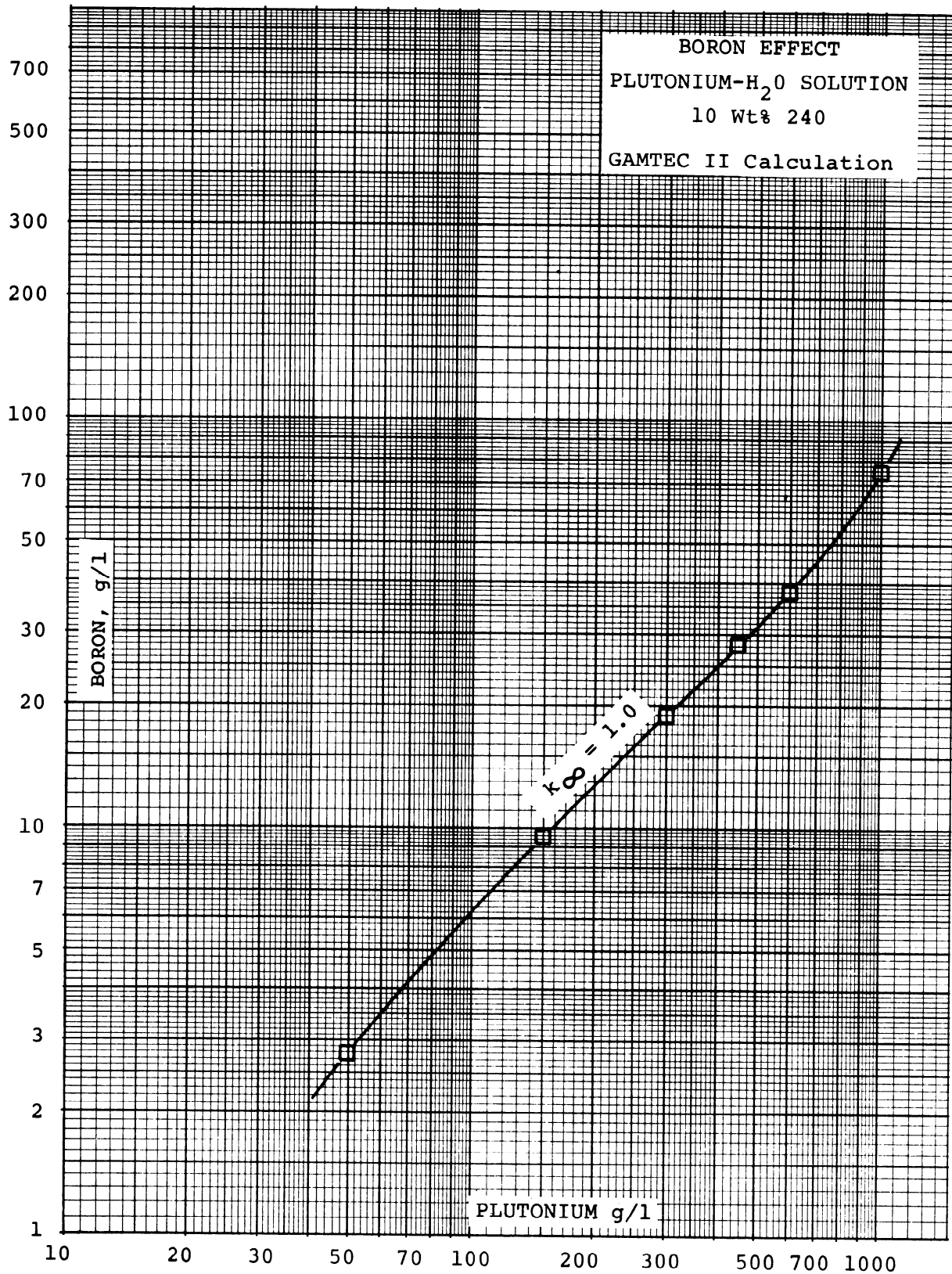

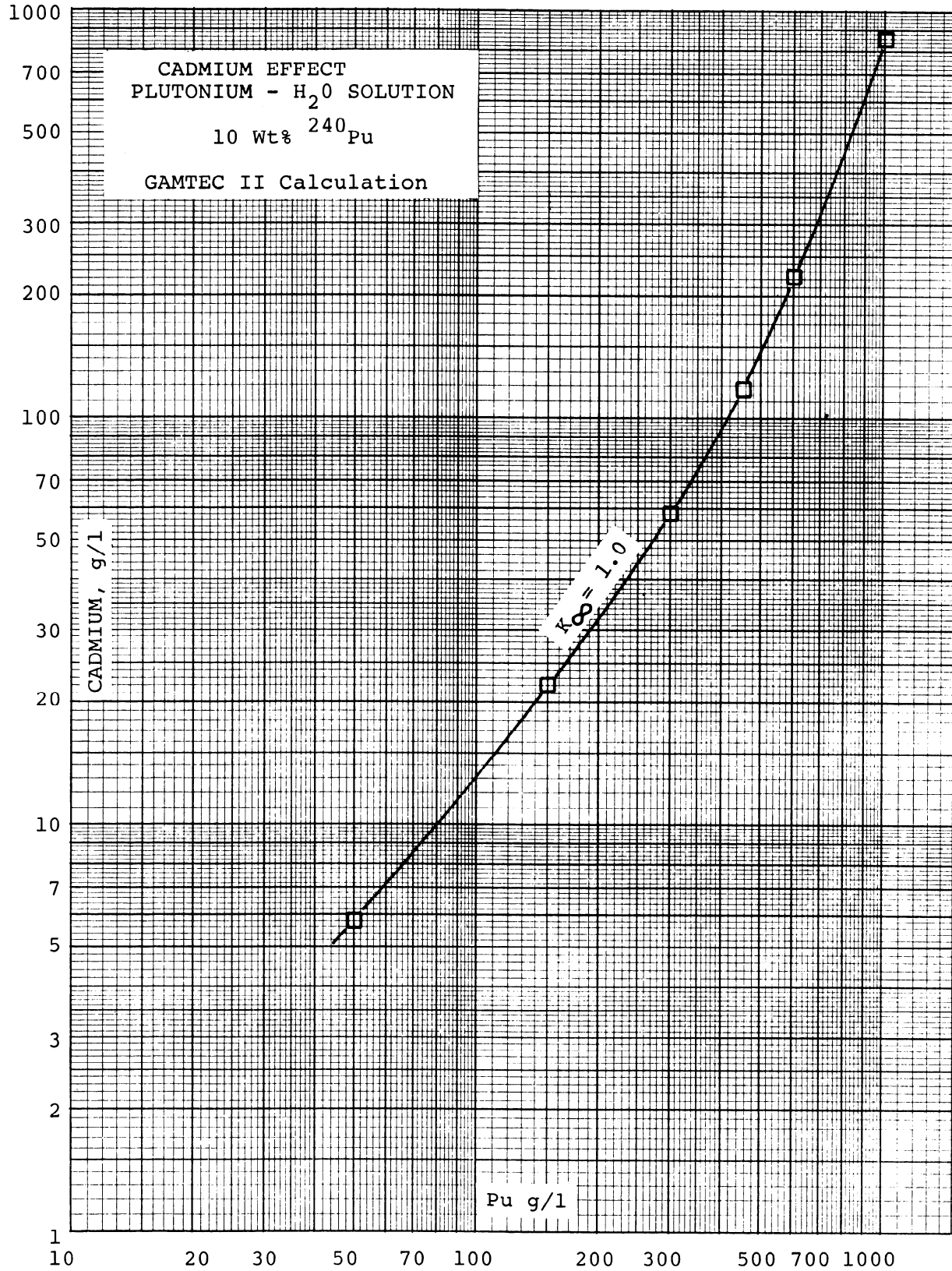

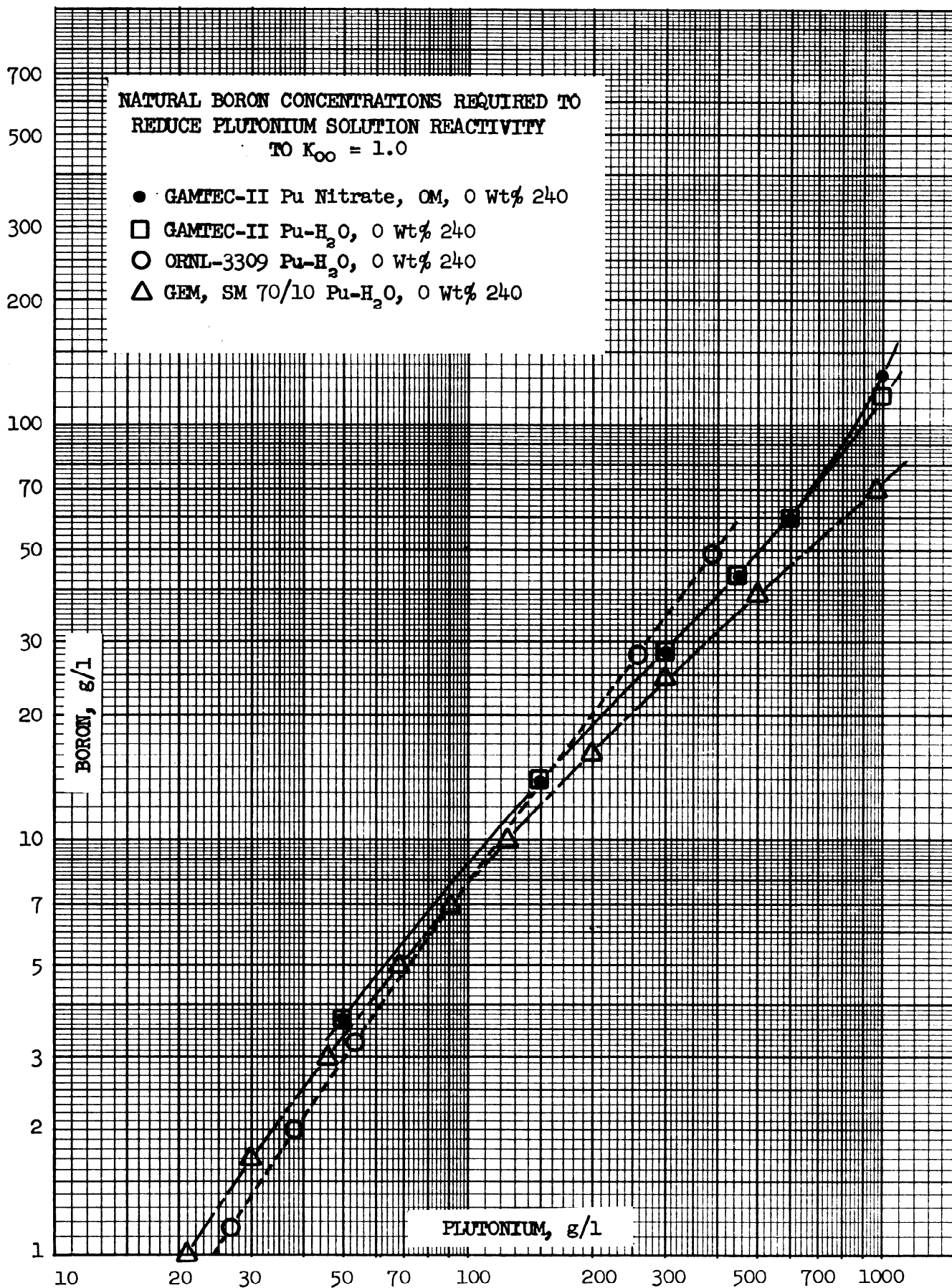

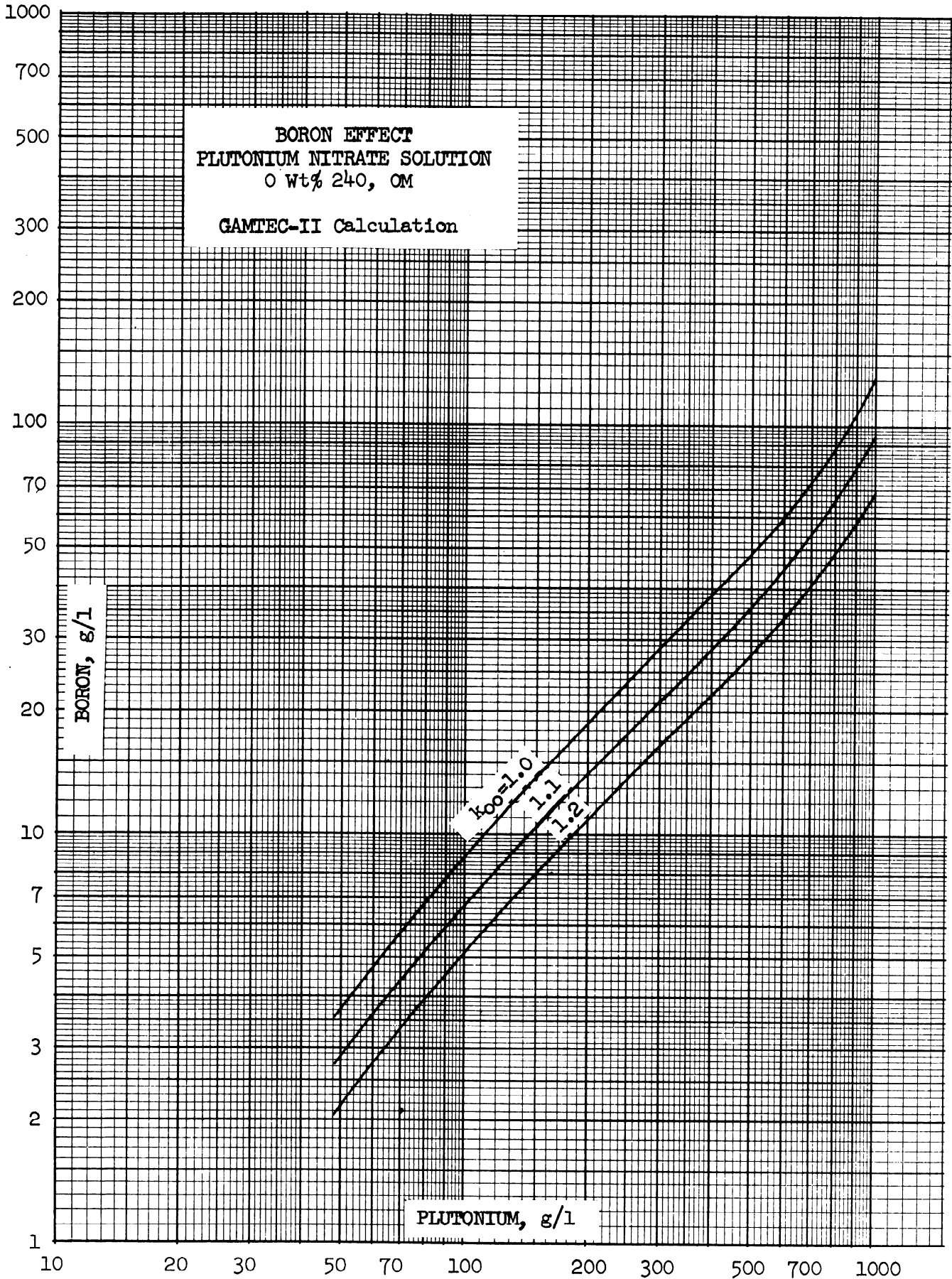

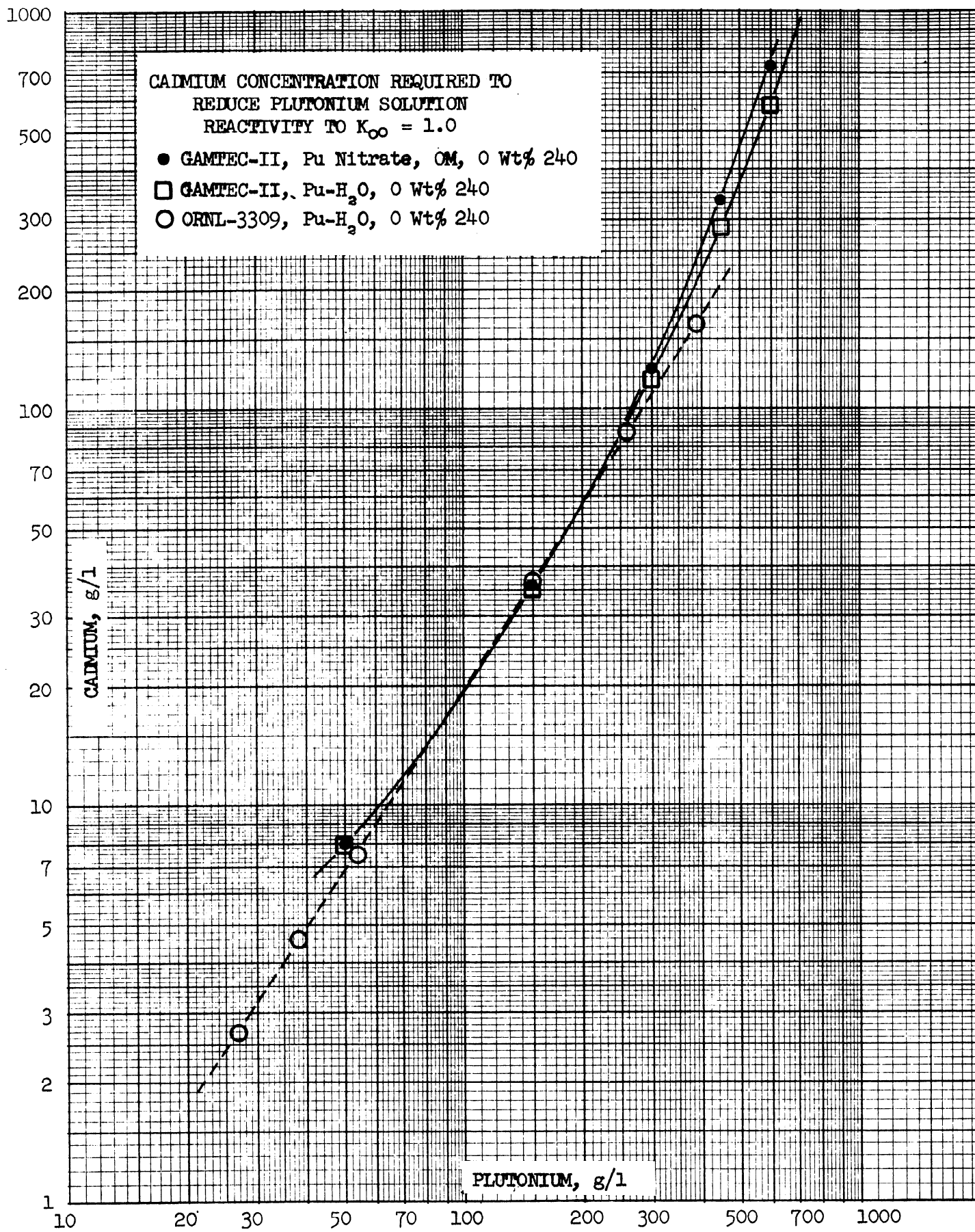

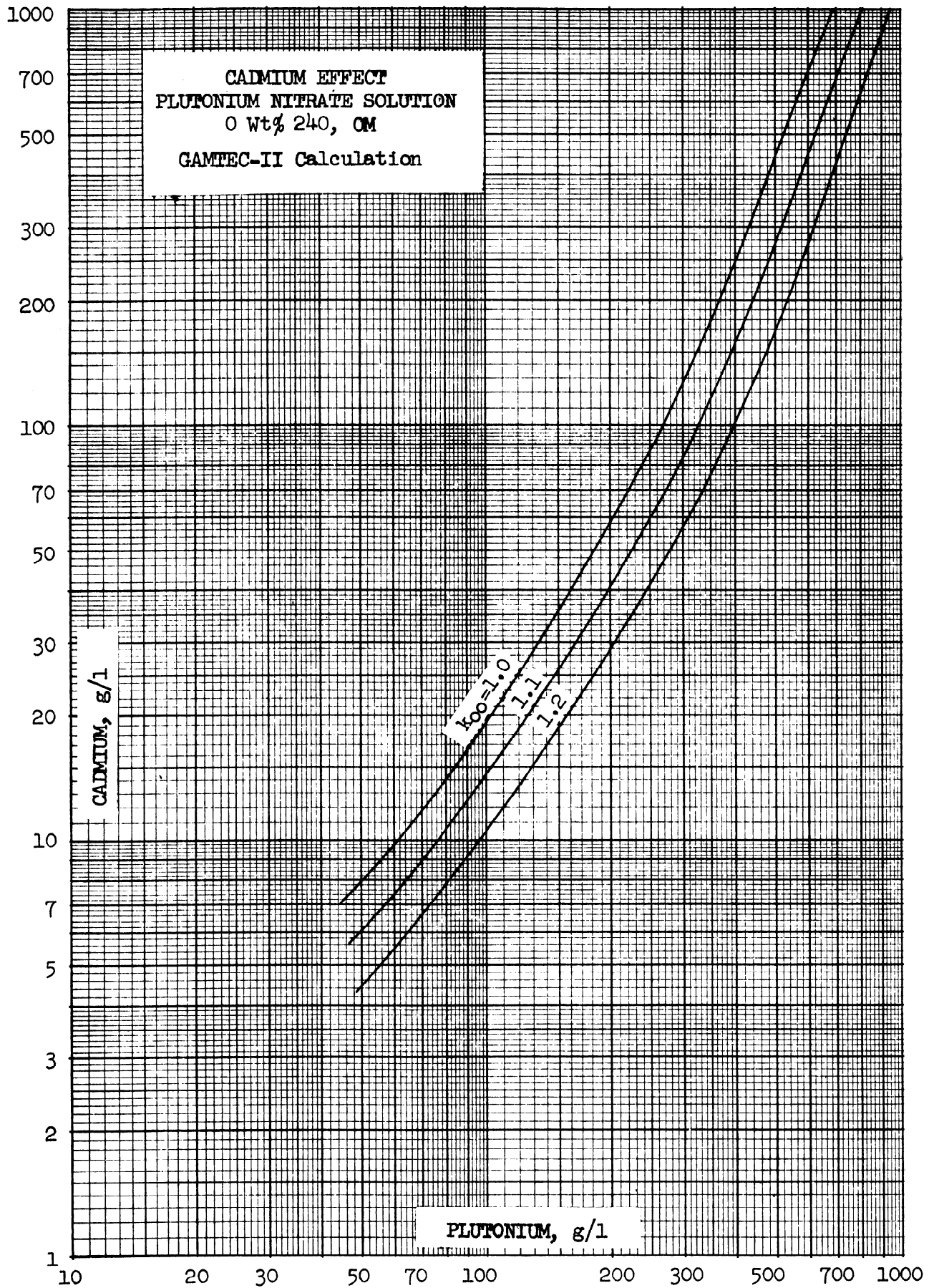

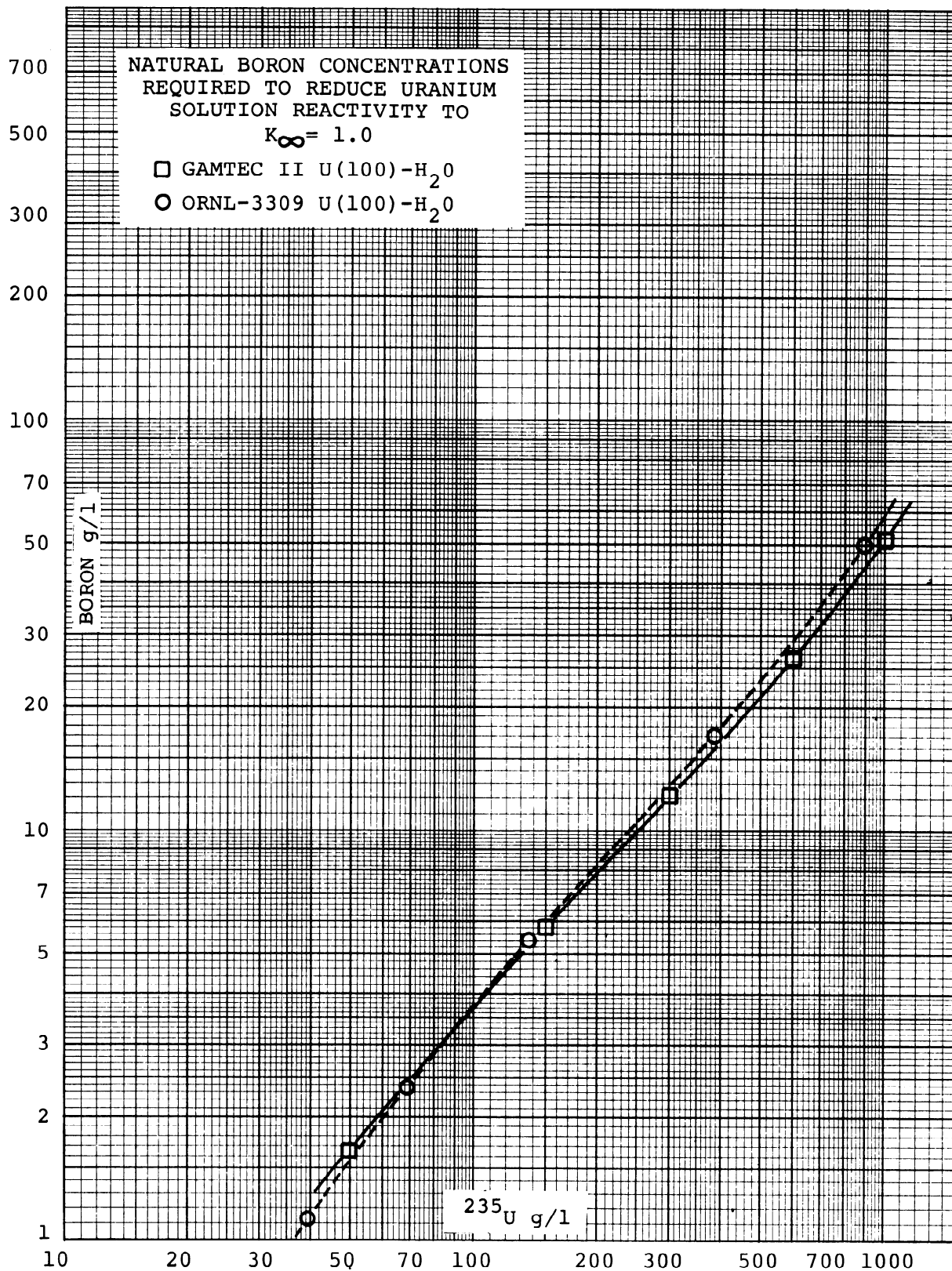

EFFECTIVE ISOLATION THICKNESS
OF SOME COMMON MATERIALS

<u>Material</u>	<u>Density</u> <u>g/cm³</u>	<u>Effective Isolation</u> <u>Thickness, In.*</u>	
		<u>BNWL-193</u> ⁽¹⁾	<u>French</u> ⁽²⁾
Polyethylene	0.917	6.9 ± .2	
Polyethylene-Cd ⁽³⁾		4.3 ± .08	
Polyethylene-Cd ⁽⁴⁾		3.7 ± .08	
Borated Polyethylene ⁽⁵⁾	.964	3.5 ± .08	
Compressed Wood	1.341	7.5 ± .2	
Concrete	2.33	9.8 ± .8	11.8 ⁽⁶⁾
Borated Concrete ⁽⁷⁾	2.33	6.9 ± .2	7.87
Lead	11.34	10.2 ± .8	
Paraffin	0.90		7.87
Paraffin-Cd ⁽⁸⁾			6.89
Borated Permali			7.09

(1) J. D. White, C. R. Richey, Neutron Interaction Between Multiplying Media Separated by various Materials, BNWL-193, 1965. This reference used a checkerboard assembly of PuO₂, Polystyrene Cubes and Plexiglass₃ Cubes at an overall H/Pu = 35.6 and 0.56 g Pu²/cm³ as the fissile material.

(2) P. R. Le Corche, Recent Experimental Critical Safety Data Obtained in France, Trans. Am. Nucl. Soc., 11, 687 (1968), fissile material unknown, compared critical heights of one vessel reflected by the media with common critical height of two vessels interacting through the media.

* "Isolation" thickness increases with core size, i.e., the bigger the facing sides, the thicker the isolating material must be. (this is the reason for the differences between columns. Be especially wary of concrete cf. "Concrete and Criticality," RHO-SA-30. R.D. CARTER 4/18

- (3) 0.02 inch Cadmium between variable core and polyethylene
- (4) 0.02 inch Cadmium sheets on both sides of polyethylene
- (5) 10 wt.% Boron
- (6) Not quite complete isolation
- (7) 2.2 wt.% Boron
- (8) 0.033 inch Cadmium sheets on both sides of paraffin.